

ФРЕЗЕРНЫЙ ИНСТРУМЕНТ



ФРЕЗЕРНЫЙ ИНСТРУМЕНТ



содержание

Руководство по подбору инструмента

Торцевые фрезы	E4
Концевые фрезы и модульные головки	E13
Кукурузные фрезы	E19
Дисковые фрезы	E21
Режущие пластины	E24

Сплавы

E33

Корпуса фрез

Торцевые фрезы	E36
Концевые и модульные фрезы	E103
Кукурузные фрезы	E159
Дисковые фрезы	E171

Обозначения



➤ Угол в плане



➤ Винт под углом



➤ Режущие пластины



➤ Режимы резания



➤ Углы врезания



➤ Исполнение посадочного места



➤ Страница Технические данные

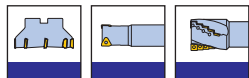

➤ Страница корпусов фрез



















Фрезерные пластины

Система обозначения режущих пластин	E190
Пластины	E192
Рекомендуемые режимы резания	E241
Исполнение посадочного места фрез	E244
Технические данные	E246
Углы врезания	E260

Руководство по подбору инструмента

Торцевые фрезы

		MILL-RUSH		MILL-RUSH		CHASEMILL	CHASEMILLPOWER
		3P TF90	6N TF90	SCRM90TN	TFM90AX 2S-TFM90AP TFM90AP	2P-TF90	
Серия							
Страницы		E36-E38	E39-E41	E42-E43	E44-E47	E48	
Угол в плане		90°	90°	90°	90°	90°	
Максимальная глубина резания (мм)		4.7-15	4.1-9.2	13-15	5.5-17.9	4.7	
Диапазон диаметров (мм)		Ø32-Ø250	Ø40-Ø250	Ø50-Ø250	Ø32-Ø200	Ø32-Ø40	
Пластина		3PK(H)T 0603 3PK(H)T 1004 3PK(H)T 1505 3PK(H)T 1906	6NKG 0403 6NGU 0604 6NGU 0905	TNMX 1806 TNM(G)X 2207	AXM(C)T 0602 APK(C)T 09T3 APK(C)T 1204 APKT 1705/06 APKT 1907	2PKT 0503	
Тип операции	Торцевая обработка 	●	●	●	●	●	
	Обработка уступа 	●	●	●	●	●	
	Обработка паза 	●	●	●	●	●	
	Фрезерование под углом 	●			●	●	
	Фрезерование по спирали 	●			●	●	
	Фрезерование фасок 						
	Профильная обработка 						
	Профильная обработка 	○	○		○		
	Ступенчатая обработка 	○	○		○		
	Обработка цековок 	○	○		○		
Сверление 							

Руководство по подбору инструмента

Торцевые фрезы

CHASE ² MILL		CHASE ^{ALU}	CHASE ² GUARD		
TFM90AN	4N TF90	TFM90XEV	Для отделки TFM90SNS	Для отделки TFM90SNS-QC	Для отделки TQ90SNS
					
E49-E50	E51	E52	E53	E54	E55
90°	90°	90°	90°	90°	90°
11-15	6	16-21	1	1	1
Ø40-Ø200	Ø32-Ø63	Ø40-Ø200	Ø50-Ø250	Ø250-Ø400	Ø250-Ø400
ANM(H)X 1106 ANM(H)X 1607	4NKT 0603	XEVT 1605 XEVT 2206	SNEX 1204 SNET 1205	SNEX 1204 SNET 1205	SNEX 1204 SNET 1205
●	●	●	●	●	●
●	●	●	○	○	○
●	●	●			
○	●	●			
○	●	●			
○					
○		●			
○		○			

● Рекомендуется, ○ Подходит

Руководство по подбору инструмента

Торцевые фрезы

Серия		LIONMILL		CHASE ² GUARD		LIONMILL
		LM90TP	LM90SE	TFM90SN TFM88SN	TFM75SN	LM75SP
Страницы		E56	E57	E58-E59	E60	E61
Угол в плане		90°	90°	90°, 88°	75°	75°
Максимальная глубина резания (мм)		17.6	17	12	9.5	9.5-12.5
Диапазон диаметров (мм)		Ø80-Ø315	Ø125-Ø315	Ø50-Ø200	Ø50-Ø250	Ø80-Ø315
Пластина		TPKN 2204	SEKX 2107	SNGX 1306... SNGX 1306 ZN	SNM(G)X 1306 EN... SNMX 1306 XTN	SPKN 1203 SPKN 1504
Тип операции	Торцевая обработка		●	●	●	●
	Обработка уступа		●	●	●	●
	Обработка паза		●	○	○	○
	Фрезерование под углом					
	Фрезерование по спирали					
	Фрезерование фасок					
	Профильная обработка					
	Профильная обработка					
	Ступенчатая обработка		○			
	Обработка цековок					
Сверление						

Руководство по подбору инструмента

















Торцевые фрезы

CHASEMILL	LIONMILL	HEXA ² MILL	CHASE ² HEPTA		
TFM75AP	LM60SC	TFM55AHNS	14D-F45XN	14D-F45XNW	14D-F45XNW-QC
					
E62	E63-E66	E67	E68-E69	E70	E71
75°	60°	55°	45°	45°	45°
3.9	13-18	5	3.5-5	5	5
Ø80-Ø125	Ø125-Ø500	Ø50-Ø160	Ø50-Ø250	Ø80-Ø315	Ø250-Ø400
APKT 1705	SCKN 2107 SCKN 2708	HNC(M)X 05	XNM(H)U 0605 XNM(H)U 0906	XNHU 0906	XNHU 0906
●	●	●	●	●	●
	●	●	●	●	●
○	○	○	○	○	○

● Рекомендуется, ○ Подходит

Руководство по подбору инструмента

Торцевые фрезы

		CHASE HEPTA		CHASE 2 GUARD		
		7S-F45-06	TFM45SN	TFM45SN-QC	TFM45SNS-16	TFM45SNS-16B-CA
Серия						
Страницы		E72	E73-E74	E75	E76	E77
Угол в плане		45°	45°	45°	45°	45°
Максимальная глубина резания (мм)		3.2	7	7	8.8	8.8
Диапазон диаметров (мм)		Ø32-Ø125	Ø40-Ø250	Ø250-Ø400	Ø63-Ø250	Ø125-Ø315
Пластина		7EMT 0604	SNM(G)X 1306 AN... SNMX 1306 XTN	SNM(G)X 1306 AN... SNMX 1306 XTN	SNMX 1607 SNHX 1606	SNMX 1607 SNHX 1606
Тип операции	Торцевая обработка		●	●	●	●
	Обработка уступа		●	●	●	●
	Обработка паза		○	○	○	○
	Фрезерование под углом		●			
	Фрезерование по спирали		●			
	Фрезерование фасок					
	Профильная обработка					
	Профильная обработка					
	Ступенчатая обработка					
	Обработка цековок					
Сверление						

Руководство по подбору инструмента

















Торцевые фрезы

CHASE ² GUARD		CHASE ² MILL		HEXA ² MILL		CHASE ² OCTO	
TFM45SNW	TQ45SNW	TFM45AN	TFM45HNS	TFM45HN	TFM430FS		
							
E78	E79	E80	E81-E82	E83	E84		
45°	45°	45°	45°	45°	43°		
8.8	8.8	8.4	6.1	6.1	3.5		
Ø80-Ø250	Ø200-Ø355	Ø50-Ø160	Ø63-Ø250	Ø80-Ø315	Ø32-Ø125		
SNHX 1606	SNHX 1606	ANHX 1607	HNHX 1006	HNHX 1006	OFCW 05T3 OFCT 05T3 OFMT 05T3 RFMT 1404		
●	●	●	●	●	●		
●	●		●	●			
○	○	○	○	○	○		

● Рекомендуется, ○ Подходит

Руководство по подбору инструмента

Торцевые фрезы

		CHASE ОСТО	LIONMILL		HEXA 2MILL	CHASE 2MOLD
		TFM4320FW	LM45SD	LM45SE	TFM15HNS	TFMRNS
Серия						
Страницы		E85	E86	E87	E88	E89-E90
Угол в плане		43°	45°	45°	15°	-
Максимальная глубина резания (мм)		5	6.5-8.7	6.5-8.7	2	5-8
Диапазон диаметров (мм)		Ø63-Ø200	Ø80-Ø315	Ø80-Ø250	Ø80-Ø125	Ø32-Ø200
Пластина		OFCN 0704 OFCR 0704 OFMR 0704 RFMR 1904	SDKN 1203 SDKN 1504	SEKN 1203 SEKN 1504	HNHX 1006-M	RNMU 1004 RNMU 1205 RNMU 1606
Тип операции	Торцевая обработка 	●	●	●	●	●
	Обработка уступа 		●	●		●
	Обработка паза 	○	○	○		●
	Фрезерование под углом 					●
	Фрезерование по спирали 					●
	Фрезерование фасок 					
	Профильная обработка 					●
	Профильная обработка 					○
	Ступенчатая обработка 					○
	Обработка цековок 					
Сверление 						

Руководство по подбору инструмента













Торцевые фрезы

CHASEMOLD		CHASESPEED	CHASE ² FEED		
TFMRX	TFMRY	TFMRN-12CH	TFMBL-06	TFMBL-09	TFMBL-13
					
E91-E92	E93-E96	E97	E98	E99	E100-E101
-	-	-	-	-	-
5-10	5-10	6.0	1	1.5	2
Ø50-Ø160	Ø32-Ø250	Ø50-Ø80	Ø32-Ø66	Ø32-Ø125	Ø40-Ø250
RXM(H)X 1003 RXM(H)X 12T3 RXMX 1604 RXMX 2006	RYM(H)X 0803 RYM(H)X 1004 RYM(H)X 1205 RYM(H)X 1606 RYMX 2007	RNGX 1207-CH	BLMP 0603	BLMP 0904	BLMP 1306
●	●	●	●	●	●
●	●	●	●	●	●
●	●	●	●	●	●
●	●	●	●	●	●
●	●	●	●	●	●
●	●	●	○	○	○
○	○	○	○	○	○
			○	○	○
			○	○	○

● Рекомендуется, ○ Подходит















Руководство по подбору инструмента

Торцевые фрезы

Серия		CHASEFEED					
		TFMSB					
							
Страницы		E102					
Угол в плане		-					
Максимальная глубина резания (мм)		2					
Диапазон диаметров (мм)		Ø50-Ø250					
Пластина		SBMT 1306					
Тип операции	Торцевая обработка		●				
	Обработка уступа		●				
	Обработка паза		●				
	Фрезерование под углом		●				
	Фрезерование по спирали		●				
	Фрезерование фасок						
	Профильная обработка		○				
	Профильная обработка		○				
	Ступенчатая обработка		○				
	Обработка цековок		○				
	Сверление						

Руководство по подбору инструмента

Концевые фрезы и модульные головки

		MILL-RUSH		MILL-RUSH		CHASEMILL	
		3P TE90	6N TE90	SCRM90TN	TE90AX-06	2S-TE90AP-09	
Серия							
Страницы		E103-E106	E107-E108	E109-E110	E111-E112	E113-E114	
Угол в плане		90°	90°	90°	90°	90°	
Максимальная глубина резания (мм)		4.7-15	4.1-9.2	13	5.5	8.8	
Диапазон диаметров (мм)		Ø12-Ø50	Ø20-Ø40	Ø35-Ø40	Ø8-Ø40	Ø10-Ø40	
Пластина		3PK(H)T 0603 3PK(H)T 1004 3PK(H)T 1505 3PK(H)T 1906	6NKU 0403 6NGU 0604 6NGU 0905	TNMX 1806	AXMT 0602 AXCT 0602	APKT 09T3 APCT 09T3	
Тип операции	Торцевая обработка 	●	●	●	●	●	
	Обработка уступа 	●	●	●	●	●	
	Обработка паза 	●	●	●	●	●	
	Фрезерование под углом 	●			●	●	
	Фрезерование по спирали 	●			●	●	
	Фрезерование фасок 						
	Профильная обработка 						
	Профильная обработка 	○	○		○	○	
	Ступенчатая обработка 	○	○		○	○	
	Обработка цековок 	○	○		○	○	
Сверление 							

● Рекомендуется, ○ Подходит







Руководство по подбору инструмента

Концевые фрезы и модульные головки

Серия		CHASEMILL			CHASEMILLPOWER	CHASE ² MILL
		TE90AP-12	TE90AP-17	2S-TE90AP-19	2P-TE90	TE90AN
Страницы		E115-E116	E117-E118	E119	E120-E121	E122-E123
Угол в плане		90°	90°	90°	90°	90°
Максимальная глубина резания (мм)		12	16.1	17.9	4.7	11-15
Диапазон диаметров (мм)		Ø16-Ø42	Ø20-Ø40	Ø40	Ø12-Ø33	Ø25-Ø50
Пластина		APKT 1204 APCT 1204	APKT 1705 APKT 1706	APKT 1907	2PKT 0503	ANM(H)X 1106 ANM(H)X 1607
Тип операции	Торцевая обработка		●	●	●	●
	Обработка уступа		●	●	●	●
	Обработка паза		●	●	●	●
	Фрезерование под углом		●	●	●	○
	Фрезерование по спирали		●	●	●	○
	Фрезерование фасок					
	Профильная обработка					
	Профильная обработка		○	○	○	○
	Ступенчатая обработка		○	○	○	○
	Обработка цековок		○	○	○	○
Сверление						

Руководство по подбору инструмента

Концевые фрезы и модульные головки

CHASE ² MILL	CHASE ALU		CHASE GUARD		
4N TE90	TE90XEV-HSK63A	TE90XEV	TSF	TDM	TCF
					
E124-E125	E126	E127-E128	E129	E130	E131
90°	90°	90°	90°	90°	45°-75°
6	16	16-21	5.6-13.4	12-40	-
Ø16-Ø40	Ø25-Ø50	Ø25-Ø40	Ø12-Ø50	Ø12-Ø50	Ø7-Ø25
4NKT 0603	XEVT 1605	XEVT 1605 XEVT 2206	XOMT 0602 SPMG(T) 0904 SPMG(T) 1104 SPMG(T) 1405	XOMT 0602 SPMG(T) 0904 SPMG(T) 1104 SPMG(T) 1405	SPMG(T) 1104
●	●	●	●	●	●
●	●	●	●	●	
●	●	●	●	●	
●	●	●	○	●	
●	●	●	○	●	●
					●
			○	●	
	●	●	○	●	
	○	○	○	●	
				●	

● Рекомендуется, ○ Подходит

Руководство по подбору инструмента

Концевые фрезы и модульные головки

Серия		CHASEHEPTA	CHASE ² MOLD	CHASEMOLD		FINEBALL	
		7S-E45-06	TERNS	TERD/TERX	TERY	TNF	
Страницы		E132	E133-E134	E135-E136	E137-E139	E140-E142	
Угол в плане		45°	-	-	-	-	
Максимальная глубина резания (мм)		3.2	5-8	2.5-10	4-10	-	
Диапазон диаметров (мм)		Ø32-Ø50	Ø25-Ø50	Ø8-Ø50	Ø16-Ø50	Ø8-Ø32	
Пластина		7EMT 0604	RNMU 1004 RNMU 1205 RNMU 1606	RDMX 05/07 RXM(H)X 1003 RXM(H)X 12T3 RXMX 1604 RXMX 2006	RYM(H)X 0803 RYM(H)X 1004 RYM(H)X 1205 RYM(H)X 1606 RYM(H)X 2007	NFB NFR	
Тип операции	Торцевая обработка		●	●	●	●	●
	Обработка уступа		●	●	●	●	●
	Обработка паза		○	●	●	●	●
	Фрезерование под углом		●	●	●	●	●
	Фрезерование по спирали		●	●	●	●	●
	Фрезерование фасок						
	Профильная обработка		●	●	●	●	●
	Профильная обработка			○	○	○	●
	Ступенчатая обработка			○			●
	Обработка цековок						●
	Сверление						●

Руководство по подбору инструмента

Концевые фрезы и модульные головки

FINEBALL	CHASESPEED	DUETBALL	TRIOBALL		CHASE²BALL
TNFR	TERP-12CH	2F	3F-W	3F-CN	TDB50X
					
E143-E145	E146	E147-E148	E149	E149	E150
-	-	-	-	-	-
-	6.0	11.8-44.7	39-80	68-94	59-69
Ø8-Ø25	Ø32-Ø40	Ø16-Ø32	Ø32-Ø50	Ø50	Ø50
NFR	RPGX 1204 CH	2FB APKT 09T3 APKT 1204	3FB CNHX 1311 CNHX 1606	3FB500C-M 3FB500P-M CNHX 1606	6RBE 50-M 6RBE 50-MR
●	●	●	●	●	●
●	●				
●	●	●	●	●	●
●	●	●	●	●	●
●	●	●	●	●	●
●	●	●	●	●	●
●	○	○	○	○	○
●		○	○	○	○
●					
●					

● Рекомендуется, ○ Подходит

Руководство по подбору инструмента

Концевые фрезы и модульные головки

		CHASE²BALL		CHASE²FEED		CHASEFEED	
		TDB50X-WT	TEBL-06	TEBL-09	TEBL-13	TESB-13	
Серия							
Страницы		E151	E152-E154	E155-E156	E157	E158	
Угол в плане		-	-	-	-	-	
Максимальная глубина резания (мм)		59-69	0.7-1	1.5	2	2	
Диапазон диаметров (мм)		Ø50	Ø16-Ø42	Ø25-Ø42	Ø32-Ø42	Ø32-Ø42	
Пластина		6RBE 50-M 6RBE 50-MR	BLMP 0603	BLMP 0904	BLMP 1306	SBMT 1306	
Тип операции	Торцевая обработка 	●	●	●	●	●	
	Обработка уступа 		●	●	●	●	
	Обработка паза 	●	●	●	●	●	
	Фрезерование под углом 	●	●	●	●	●	
	Фрезерование по спирали 	●	●	●	●	●	
	Фрезерование фасок 						
	Профильная обработка 	●	○	○	○	○	
	Профильная обработка 	○	○	○	○	○	
	Ступенчатая обработка 	○	○	○	○	○	
	Обработка цековок 		○	○	○	○	
Сверление 							

Руководство по подбору инструмента















Кукурузные фрезы

		MILL-RUSH		MILL-RUSH	CHASE ² MILL	CHASEMILL
Серия		3P TEF-06	3P TEF-10/15/19 3P TES-10/15/19	TEF-TN18 TES-TN18	TEF-AN11/16 TES-AN11/16	TEF-AX06
Страницы		E159	E160-E162	E163	E164-E165	E166
Угол в плане		90°	90°	90°	90°	90°
Максимальная глубина резания (мм)		20-32	40-83	48-71	40-69	16-26
Диапазон диаметров (мм)		Ø20-Ø32	Ø32-Ø100	Ø50-Ø100	Ø32-Ø100	Ø16-Ø25
Пластина		3PK(H)T 0603	3PK(H)T 1004 3PK(H)T 1505 3PK(H)T 1906	TNMX 1806	ANM(H)X 1106 ANM(H)X 1607	AXMT 0602 AXCT 0602
Тип операции	Торцевая обработка		○	○	○	○
	Обработка уступа		●	●	●	●
	Обработка паза		●	●	●	●
	Фрезерование под углом					
	Фрезерование по спирали		○	○	○	○
	Фрезерование фасок					
	Профильная обработка					
	Профильная обработка					
	Ступенчатая обработка					
	Обработка цековок					
	Сверление					

● Рекомендуется, ○ Подходит

Руководство по подбору инструмента

Кукурузные фрезы

		CHASEMILL		CHASEGUARD		
		2S-TEF-AP09	TEF-AP12/17 TES-AP12/17	TEF TES		
Серия						
Страницы		E167	E168-E169	E170		
Угол в плане		90°	90°	90°		
Максимальная глубина резания (мм)		26-42	30-88	25-60		
Диапазон диаметров (мм)		Ø20-Ø32	Ø25-Ø100	Ø32-Ø100		
Пластина		APKT 09T3 APCT 09T3	APKT 1204 APKT 1705 APKT 1706	SPMG(T) 0904 SPMG(T) 1104 SPMG(T) 1405		
Тип операции	Торцевая обработка		○	○	○	
	Обработка уступа		●	●	●	
	Обработка паза		●	●	●	
	Фрезерование под углом					
	Фрезерование по спирали		○	○		
	Фрезерование фасок					
	Профильная обработка					
	Профильная обработка				○	
	Ступенчатая обработка					
	Обработка цековок				○	
Сверление						

Руководство по подбору инструмента

















Дисковые фрезы

		TOPSLOT				
		TSM-TS16	TSM-SL	TSM-FD-Z	TSM-FD-ZN08	TSM-FD-S/W-ZN08
Серия						
Страницы		E171-E172	E173-E174	E175-E176	E177	E178
Угол в плане		-	-	-	-	-
Максимальная глубина резания (мм)		1.2-6	3-6	3-10	10-12	10-14
Диапазон диаметров (мм)		Ø32-Ø80	Ø25-Ø63	Ø63-Ø250	Ø80-Ø125	Ø100-Ø250
Пластина		TS16	SLOT	ZNHT...	ZNHU 080	ZNHU 080
Тип операции	Торцевая обработка 	○	○	○	○	○
	Обработка уступа 	○	○	○	○	○
	Обработка паза 	●	●	●	●	●
	Фрезерование под углом 					
	Фрезерование по спирали 					
	Обработка канавок 	●	●	●	●	●
	Профильная обработка 					
	Профильная обработка 					
	Ступенчатая обработка 					
	Обработка цепок 					
	Сверление 					

● Рекомендуется, ○ Подходит

Руководство по подбору инструмента

Дисковые фрезы

Серия		TOP SLOT				
		TSM-FD-ZN11	TSM-FD-S/W-ZN11	TSM-FD-S/W-ZN14	TSM-FF-Z	TSM-FF-ZN08
						
Страницы		E179	E180	E181	E182	E183
Угол в плане		-	-	-	-	-
Максимальная глубина резания (мм)		14-20	14-20	20-26	3-10	10-12
Диапазон диаметров (мм)		Ø125	Ø100-Ø315	Ø125-Ø315	Ø80-Ø160	Ø63-Ø125
Пластина		ZNHU 110	ZNHU 110	ZNHU 140	ZNHT...	ZNHU 080
Тип операции	Торцевая обработка		○	○	○	○
	Обработка уступа		○	○	○	○
	Обработка паза		●	●	●	●
	Фрезерование под углом					
	Фрезерование по спирали					
	Обработка канавок		●	●	●	●
	Профильная обработка					
	Профильная обработка					
	Ступенчатая обработка					
	Обработка цековок					
Сверление						

Руководство по подбору инструмента

















Дисковые фрезы

TOP SLOT				Дисковая фреза TSC	
TSM-FF-S/W-ZN08	TSM-FF-ZN11	TSM-FF-S/W-ZN11	TSM-FF-S/W-ZN14	TSC	
					
E184	E185	E186	E187	E188	
-	-	-	-	-	
10-14	14-20	14-20	20-26	1.6-4.52	
Ø100-Ø200	Ø63-Ø125	Ø100-Ø315	Ø125-Ø315	Ø75-Ø160	
ZNHU 080	ZNHU 110	ZNHU 110	ZNHU 140	TIMC TIMJ TIPV	
○	○	○	○		
○	○	○	○		
●	●	●	●	●	
●	●	●	●	●	

● Рекомендуется, ○ Подходит

Руководство по подбору инструмента

Режущие пластины

Серия	MILL-RUSH					MILL-RUSH					CHASEMILL														
	3PK(H)T 0603 3PK(H)T 1004 3PK(H)T 1505 3PK(H)T 1906					6NKU 0403 6NGU 0604 6NGU 0905					TNMX 1806 TNM(G)X 2207					AXM(C)T 0602 APK(C)T 09T3 APK(C)T 1204 APKT 1705/1706 APKT 1907					APCT 12-PCD35				
																									
Материал	P	M	K	N	S	H	P	M	K	N	S	H	P	M	K	S	H	P	M	K	N	S	H	N	
Страницы	E194-E195					E196-E197					E233					E200-E205					E201				
Угол в плане	90°					90°					90°					90°					90°				
Максимальная глубина резания (мм)	4.7-15					4.1-9.2					13-15					5.75-16.1					3.5				
Тип операции	Торцевая обработка		●	●	●	●	●	●	●	●	●	●	●	●	●	●	●	●	●	●	●	●	●		
	Обработка уступа		●	●	●	●	●	●	●	●	●	●	●	●	●	●	●	●	●	●	●	●	●	●	
	Обработка паза		●	●	●	●	●	●	●	●	●	●	●	●	●	●	●	●	●	●	●	●	●	●	
	Фрезерование под углом		●	●	●	●	●	●	●	●	●	●	●	●	●	●	●	●	●	●	●	●	●	●	
	Фрезерование по спирали		●	●	●	●	●	●	●	●	●	●	●	●	●	●	●	●	●	●	●	●	●	●	
	Фрезерование фасок		●	●	●	●	●	●	●	●	●	●	●	●	●	●	●	●	●	●	●	●	●	●	●
	Профильная обработка		●	●	●	●	●	●	●	●	●	●	●	●	●	●	●	●	●	●	●	●	●	●	●
	Профильная обработка		○	○	○	○	○	○	○	○	○	○	○	○	○	○	○	○	○	○	○	○	○	○	○
	Ступенчатая обработка		○	○	○	○	○	○	○	○	○	○	○	○	○	○	○	○	○	○	○	○	○	○	○
	Обработка цековок		○	○	○	○	○	○	○	○	○	○	○	○	○	○	○	○	○	○	○	○	○	○	○
Сверление		○	○	○	○	○	○	○	○	○	○	○	○	○	○	○	○	○	○	○	○	○	○	○	

Руководство по подбору инструмента













Режущие пластины

CHASE MILL POWER	CHASE 2 MILL		CHASE ALU	CHASE 2 GUARD	LIONMILL
2PKT 0503	ANM(H)X 1106 ANM(H)X 1607	4NKT 0603	XEVT 1605 XEVT 2206	SNEX 1204 SNET 1205	TPKN 2204
					
P M K S H	P M K N S H	P M K S H	N	P K	P M K
E192	E199	E195	E236	E224	E234
90°	90°	90°	90°	90°	90°
4.7	11-15	5.5-6	14-21	1	16
●	●	●	●	●	●
●	●	●	●	○	●
●	●	●	●		●
●	○	●	●		
●	○	●	●		
	○	●			
	○	●	●		○
	○		○		

● Рекомендуется, ○ Подходит

Руководство по подбору инструмента

Режущие пластины

Серия	LIONMILL		CHASE ² GUARD		LIONMILL		CHASEMILL							
	SEKX 2107		SNGX 1306... SNGX 1306 ZN		SNM(G)X 1306 EN... SNMX 1306 XTN		SPKN 1203 SPKN 1504		APKT 1705					
														
Материал	P	K	P	M	K	P	M	K	P	M	K	N	S	H
Страницы	E222		E226		E225		E229		E203					
Угол в плане	90°		90°, 88°		75°		75°		75°					
Максимальная глубина резания (мм)	17		12		9.5		9.5-12.5		3.9					
Тип операции	Торцевая обработка		●	●	●	●	●	●	●	●	●	●	●	●
	Обработка уступа		●	●	●	●	●	●	●	●	●	●	●	●
	Обработка паза		○	○	○	○	○	○	○	○	○	○	○	○
	Фрезерование под углом													
	Фрезерование по спирали													
	Фрезерование фасок													
	Профильная обработка													
	Профильная обработка													
	Ступенчатая обработка													
	Обработка цековок													
	Сверление													

Руководство по подбору инструмента

Режущие пластины

LIONMILL		HEXA ² MILL		CHASE ² HEPTA		CHASEHEPTA		CHASE ² GUARD					
SCKN 2107 SCKN 2708		HNC(M)X 0504 HNCX 0506 HNCX 05R/L-W		XNM(H)U 0605 XNM(H)U 0906		7EMT 0604		SNM(G)X 1306 AN... SNMX 1306 XTN		SNMX 1607 SNHX 1606			
													
P	K	P	K	P	M	K	P	M	K	N	P	M	K
E221		E209		E237-E238		E198		E225		E227			
60°		55°		45°		45°		45°		45°			
13-18		5		3.5-5.0		3.2		7		8.8			
●		●		●		●		●		●		●	
●		●		●		●		●		●		●	
○		○		○		●		○		○		○	
						●							
						●							
						●							

● Рекомендуется, ○ Подходит







Руководство по подбору инструмента

Режущие пластины

Серия	CHASE ² MILL		HEXA ² MILL		CHASEOCTO		LIONMILL			
	ANHX 1607		HNHX 1006		OFCW 05T3 OFCT 05T3 OFMT 05T3 RFMT 1404		OFCN 0704 OFCR 0704 OFMR 0704 RFMR 1904		SDKN 1203 SDKN 1504	
Материал	P M K N S		P M K		P M K N		P M K N		P	
Страницы	E199		E210		E215		E214		E221	
Угол в плане	45°		45°		43°		43°		45°	
Максимальная глубина резания (мм)	8.4		6.1		3.5-7.0		5-9.5		6.5-8.7	
Тип операции	Торцевая обработка		●	●	●	●	●	●	●	●
	Обработка уступа			●						●
	Обработка паза		○	○	○	○	○	○	○	○
	Фрезерование под углом									
	Фрезерование по спирали									
	Фрезерование фасок									
	Профильная обработка									
	Профильная обработка									
	Ступенчатая обработка									
	Обработка цефок									
	Сверление									

Руководство по подбору инструмента

Режущие пластины

LIONMILL	HEXA ² MILL	CHASE ² MOLD	CHASEMOLD		CHASESPEED
SEKN 1203 SEKN 1504	HNHX1006	RNMU 1004 RNMU 1205 RNMU 1606	RDMX 05/07 RXM(H)X 1003 RXM(H)X 12T3 RXMX 1604 RXMX 2006	RYM(H)X 0803 RYM(H)X 1004 RYM(H)X 1205 RYM(H)X 1606 RYMX 2007	RPGX 1204 CH RNGX 1207 CH
					
P	P K	P M K S H	P M K N S	P M K N S H	P M K S
E222	E210	E216	E217	E218-E219	E216
45°	15°	-	-	-	-
6.5-8.7	2	5-8	5-10	5-10	6.0
●	●	●	●	●	●
●		●	●	●	●
○		●	●	●	●
		●	●	●	●
		●	●	●	●
		●	●	●	●
		○	○	○	○
		○			

● Рекомендуется, ○ Подходит

















Руководство по подбору инструмента

Режущие пластины

Серия	CHASE ² FEED		CHASEFEED	CHASEQUAD	FINEBALL
	BLMP 0603 BLMP 0904	BLMP 1306	SBMT 1306	SPMG(T) 0904 SPMG(T) 1104 SPMG(T) 1405 XOMT 0602	NFB
Материал	P M K S H P M K S H	P M K S H P M K S H	P M K S H	P M K	P M K S H
Страницы	E206	E207	E220	E228	E211
Угол в плане	-	-	-	15°-45°, 90°	-
Максимальная глубина резания (мм)	1-1.5	2	2	18-60	-
Тип операции	Торцевая обработка 	●	●	●	●
	Обработка уступа 	●	●	●	●
	Обработка паза 	●	●	●	●
	Фрезерование под углом 	●	●	●	●
	Фрезерование по спирали 	●	●	●	●
	Фрезерование фасок 				●
	Профильная обработка 	○	○	○	●
	Профильная обработка 	○	○	○	●
	Ступенчатая обработка 	○	○	○	●
	Обработка цековок 	○	○	○	●
Сверление 				●	

Руководство по подбору инструмента















Режущие пластины

		<i>FINEBALL</i>	<i>DIETBALL</i>	<i>TRIOBALL</i>	<i>CHASE²BALL</i>	<i>TOPSLOT</i>
Серия		NFR	2FB	3FB	6RBE	TS16
						
Материал		P M K S H	P M K S H	P M K S H	P M K S H	P
Страницы		E212-E213	E192	E193	E197	E235
Угол в плане		-	-	-	-	-
Максимальная глубина резания (мм)		-	11.8-44.7	39-94	59-69	4.8
Тип операции	Торцевая обработка 	●	●	●	●	○
	Обработка уступа 	●				○
	Обработка паза 	●	●	●	●	●
	Фрезерование под углом 	●	●	●	●	
	Фрезерование по спирали 	●	●	●	●	
	Обработка канавок 					●
	Профильная обработка 	●	●	●	●	
	Профильная обработка 	●	○	○	○	
	Ступенчатая обработка 	●	○	○	○	
	Обработка цековок 	●				
Сверление 	●					

● Рекомендуется, ○ Подходит

Руководство по подбору инструмента

Режущие пластины

Серия	TOP SLOT			Для дисковых фрез TSC
	SLOT	ZNHT	ZNHU	TIMC TIMJ TIPV
				
Материал	P M K	P M K N	P M K	P M K N
Страницы	E223	E239	E240	E230-E232
Угол в плане	-	-	-	-
Максимальная глубина резания (мм)	*	*	*	*
Тип операции	Торцевая обработка 	○	○	○
	Обработка уступа 	○	○	○
	Обработка паза 	●	●	●
	Фрезерование под углом 			
	Фрезерование по спирали 			
	Обработка канавок 	●	●	●
	Профильная обработка 			
	Профильная обработка 			
	Ступенчатая обработка 			
	Обработка цепок 			
	Сверление 			

*Тmax смотреть на странице с параметрами фрезы

● Рекомендуется, ○ Подходит

Сплавы

Твёрдые сплавы

Сплавы	ISO	Характеристика и применение
K10 Твердый сплав	K05 – K15 N05 – N15 S05 – S15	• Общая обработка чугуна, алюминиевых сплавов и цветных металлов
P30 Твердый сплав	P25 – P35	• Общая обработка стали
 TT2510 Покрытие PVD	P05 – P25 H05 – H25	• Высокоскоростная обработка высоколегированной и закаленной стали
 TT6080 Покрытие CVD	K05 – K25 H05 – H25	• Общая обработка серого и высокопрочного чугуна • Чистовая и получистовая обработка закаленных сталей
 TT7080 Покрытие PVD	P05 – P25 K05 – K25	• Фрезерование стали • Для прерывистого резания чугуна
 TT9080 Покрытие PVD	P20 – P40 M20 – M40 S20 – S40	• Обработка стали, нержавеющей стали и жаропрочных сплавов
TT9030 Покрытие PVD	P20 – P40 M20 – M40 S20 – S40	• Обработка стали, нержавеющей стали и жаропрочных сплавов
 TT8080 Покрытие PVD	P30 – P50 M30 – M50 S30 – S50	• Прерывистая и черновая обработка стали и нержавеющей стали • Низкоскоростная и прерывистая обработка жаропрочных сплавов
TT8020 Покрытие PVD	P30 – P50 M30 – M50 S30 – S50	• Прерывистая и черновая обработка стали и нержавеющей стали • Низкоскоростная и прерывистая обработка жаропрочных сплавов
TT5505 Покрытие PVD	P05 – P25 H05 – H25	• Высокоскоростная обработка высоколегированной и закаленной стали
TT5515 Покрытие PVD	P10 – P30 M10 – M30 K10 – K30 S10 – S30 H10 – H30	• Высокоскоростная обработка стали и закаленной стали • Обработка нержавеющей стали, чугуна и жаропрочных сплавов
TT5525 Покрытие PVD	P20 – P40 M20 – M40 S20 – S40	• Обработка стали, нержавеющей стали и жаропрочных сплавов
 TT7515 Покрытие CVD	K05 – K25 H05 – H25	• Общая обработка серого и высокопрочного чугуна • Чистовая и получистовая обработка закаленных сталей
 TT7800 Покрытие CVD	P30 – P45 M30 – M45	• Черновая обработка и высокоскоростное сверление углеродистой и легированной стали • Фрезерование нержавеющей стали на средних скоростях

Сплавы

Кермет, керамика, и CBN (кубический нитрид бора)

Сплавы	ISO	Характеристика и применение
CT7000 Кермет без покрытия	K05 – K15 N05 – N15 S05 – S15	• Чистовая обработка стали и нержавеющей стали
AS10 Керамика	K20 – K30	• Общая обработка чугуна
AS20 Керамика	S05 – S20	• Высокоскоростная обработка жаропрочных сплавов
KB90 CBN	K15 – K25 S05 – S20	• Высокоскоростная обработка чугуна • Обработка жаропрочных сплавов

Корпуса фрез



Торцевая фреза

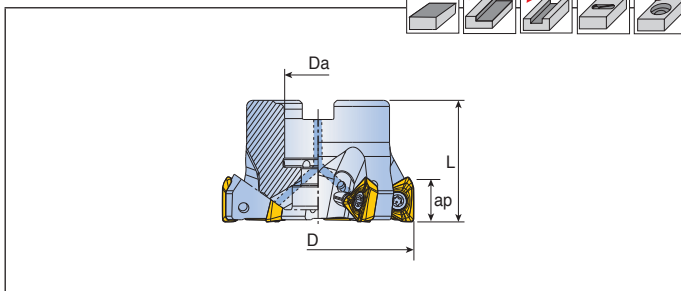
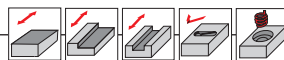

Обозначение		Размеры (мм)				Каналы СОЖ	Исполнение корпуса	кг	Крепежный болт	Пластина
		D	Da	L	ap					
3P TF90-632-16R-06	6	32	16	32	4.7	●	A	0.1	SH M8x1.25x25	ЗРК(Н)Т 0603...
732-16R-06	7	32	16	32	4.7	●	A	0.1	SH M8x1.25x25	E194
735-16R-06	7	35	16	35	4.7	●	A	0.1	SH M8x1.25x30	
840-16R-06	8	40	16	40	4.7	●	A	0.2	SH M8x1.25x30	
840-22R-06	8	40	22	40	4.7	●	A	0.2	SH M10x1.5x30	
3P TF90-540-16R-10	5	40	16	40	7	●	A	0.3	SH M8x1.25x30	ЗРК(Н)Т 1004...
640-16R-10	6	40	16	40	7	●	A	0.3	SH M8x1.25x30	E194
650-22R-10	6	50	22	40	7	●	A	0.4	SH M10x1.5x30	
750-22R-10	7	50	22	40	7	●	A	0.4	SH M10x1.5x30	
663-22R-10	6	63	22	40	7	●	A	0.5	SH M10x1.5x30	
863-22R-10	8	63	22	40	7	●	A	0.5	SH M10x1.5x30	
963-22R-10	9	63	22	40	7	●	A	0.5	SH M10x1.5x30	
3P TF90-450-22R-15	4	50	22	40	11	●	A	0.3	SH M10x1.5x30	ЗРК(Н)Т 1505...
550-22R-15	5	50	22	40	11	●	A	0.3	SH M10x1.5x30	E194-E195
463-22R-15-B	4	63	22	40	11	●	A	0.5	SH M10x1.5x30	
663-22R-15	6	63	22	40	11	●	A	0.5	SH M10x1.5x30	
480-27R-15-B	4	80	27	50	11	●	A	1.0	SH M12x1.75x35	
780-27R-15	7	80	27	50	11	●	A	1.0	SH M12x1.75x35	
880-27R-15	8	80	27	50	11	●	A	1.0	SH M12x1.75x35	
6100-32R-15-B	6	100	32	50	11	●	A	1.8	LH M16x2x35	
8100-32R-15	8	100	32	50	11	●	A	1.9	LH M16x2x35	
10100-32R-15	10	100	32	50	11	●	A	1.9	LH M16x2x35	
7125-40R-15-B	7	125	40	63	11	●	A	3.0	SH M20x2.5x40	
10125-40R-15	10	125	40	63	11	●	A	3.1	SH M20x2.5x40	
12125-40R-15	12	125	40	63	11	●	A	3.1	SH M20x2.5x40	
12160-40R-15	12	160	40	63	11	x	C	4.4	-	
15160-40R-15	15	160	40	63	11	x	C	4.4	-	
15200-60R-15	15	200	60	63	11	x	C	6.0	-	
18200-60R-15	18	200	60	63	11	x	C	5.8	-	

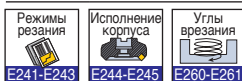

3P TF90-19

Торцевая фреза

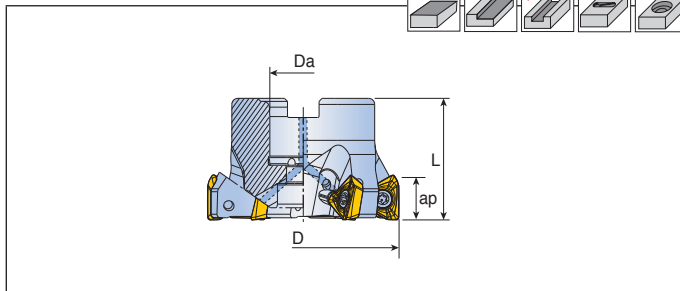
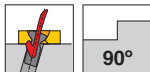
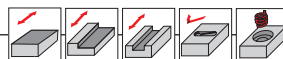

Обозначение		Размеры (мм)				Каналы СОЖ	Исполнение корпуса	Kg	Крепежный болт	Пластина
		D	Da	L	ap					
3P TF90-463-22R-19	4	63	22	40	15	●	A	0.4	SH M10x1.5x30	3РК(Н)Т 1906... E194-E195
663-22R-19	6	63	22	40	15	●	A	0.9	SH M10x1.5x30	
480-27R-19	4	80	27	50	15	●	A	0.9	SH M12x1.75x35	
780-27R-19	7	80	27	50	15	●	A	1.0	SH M12x1.75x35	
6100-32R-19	6	100	32	50	15	●	A	1.8	LH M16x2x35	
8100-32R-19	8	100	32	50	15	●	A	2.6	LH M16x2x35	
8125-40R-19	8	125	40	63	15	●	A	3.0	SH M20x2.5x40	
10125-40R-19	10	125	40	63	15	●	A	3.1	SH M20x2.5x40	
8160-40R-19	8	160	40	63	15	x	C	4.2	-	
12160-40R-19	12	160	40	63	15	x	C	4.3	-	
10200-60R-19	10	200	60	63	15	x	C	6.0	-	
14200-60R-19	14	200	60	63	15	x	C	6.0	-	
12250-60R-19	12	250	60	63	15	x	C	10.5	-	
16250-60R-19	16	250	60	63	15	x	C	10.5	-	

Режимы резания

E241-E243

Исполнение корпуса

E244-E245

Углы врезания

E260-E261

3P TF90-15/19

MILL-RUSH

Торцевая фреза (дюйм)

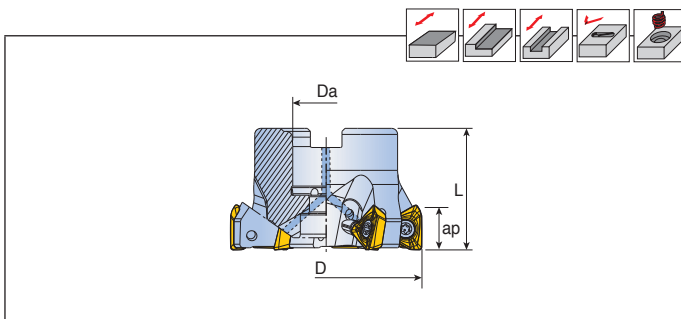
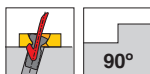

Обозначение		Размеры (мм)				Каналы СОЖ	Исполнение корпуса	Kg	Крепежный болт	Пластина
		D	Da	L	ap					
3P TF90-780-25.4R-15	7	80	25.4	50	11	●	A	1.0	SH M12x1.75x35	3РК(Н)Т 1505... E194-E195
880-25.4R-15	8	80	25.4	50	11	●	A	1.0	SH M12x1.75x35	
8100-31.75R-15	8	100	31.75	50	11	x	B	1.9	-	
10100-31.75R-15	10	100	31.75	50	11	x	B	1.9	-	
10125-38.1R-15	10	125	38.1	63	11	x	B	3.1	-	
12125-38.1R-15	12	125	38.1	63	11	x	B	3.1	-	
12160-50.8R-15	12	160	50.8	63	11	x	B	4.4	-	
15160-50.8R-15	15	160	50.8	63	11	x	B	4.4	-	
15200-47.625R-15	15	200	47.625	63	11	x	C	6.0	-	
3P TF90-480-25.4R-19	4	80	25.4	50	15	●	A	0.9	SH M12x1.75x35	3РК(Н)Т 1906... E194-E195
780-25.4R-19	7	80	25.4	50	15	●	A	1.0	SH M12x1.75x35	
6100-31.75R-19	6	100	31.75	50	15	x	B	1.8	-	
8100-31.75R-19	8	100	31.75	50	15	x	B	2.6	-	
8125-38.1R-19	8	125	38.1	63	15	x	B	3.0	-	
10125-38.1R-19	10	125	38.1	63	15	x	B	3.1	-	
8160-50.8R-19	8	160	50.8	63	15	x	B	4.2	-	
12160-50.8R-19	12	160	50.8	63	15	x	B	4.3	-	
10200-47.625R-19	10	200	47.625	63	15	x	C	6.0	-	
14200-47.625R-19	14	200	47.625	63	15	x	C	6.0	-	

• Крепежные болты с каналом под СОЖ доступны по запросу (Пример заказа: SH M10x1.5x30-C)

Запчасти

Обозначение	Винт	Ключ			
3P TF90-06	TS 20043I/HG-P	TD6P			
3P TF90-10	TS 25C065I/HG	TD8			
3P TF90-15	TS 40B100I	TD15			
3P TF90-19	TS 45120I	T-T20			



6N TF90-04



Торцевая фреза

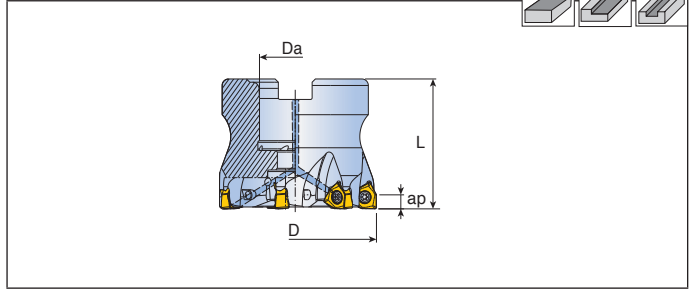
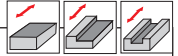

Обозначение		Размеры (мм)				Каналы СОЖ	Исполнение корпуса	кг	Крепежный болт	Пластина
		D	Da	L	ap					
6N TF90-540-16R-04	5	40	16	40	4.1	•	A	0.2	SH M8x1.25x30	6NKU 0403...
740-16R-04	7	40	16	40	4.1	•	A	0.2	SH M8x1.25x30	E197
750-22R-04	7	50	22	40	4.1	•	A	0.3	LH M10x1.5x25	
950-22R-04	9	50	22	40	4.1	•	A	0.3	LH M10x1.5x25	
863-22R-04	8	63	22	40	4.1	•	A	0.5	LH M10x1.5x25	
1063-22R-04	10	63	22	40	4.1	•	A	0.5	LH M10x1.5x25	

Режимы резания E241-E243
 Исполнение корпуса E244-E245

• Крепежные болты с каналом под СОЖ доступны по запросу (Пример заказа: SH M10x1.5x30-C)

Торцевая фреза

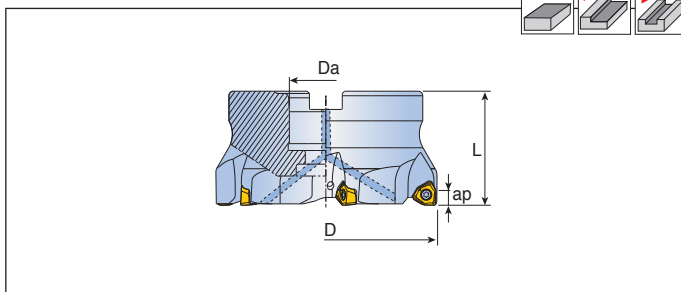
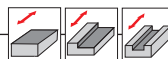

Обозначение		Размеры (мм)				Каналы СОЖ	Исполнение корпуса	Kg	Крепежный болт	Пластина
		D	Da	L	ap					
6N TF90-440-16R-06	4	40	16	40	6.2	●	A	0.3	SH M8x1.25x30	6NGU 0604...
450-22R-06	4	50	22	40	6.2	●	A	0.4	LH M10x1.5x25	E196
650-22R-06	6	50	22	40	6.2	●	A	0.4	LH M10x1.5x25	
463-22R-06	4	63	22	40	6.2	●	A	0.5	LH M10x1.5x25	
663-22R-06	6	63	22	40	6.2	●	A	0.5	LH M10x1.5x25	
763-22R-06	7	63	22	40	6.2	●	A	0.5	LH M10x1.5x25	
580-27R-06	5	80	27	50	6.2	●	A	1.0	SH M12x1.75x35	
780-27R-06	7	80	27	50	6.2	●	A	1.0	SH M12x1.75x35	
980-27R-06	9	80	27	50	6.2	●	A	1.0	SH M12x1.75x35	
6100-32R-06	6	100	32	50	6.2	●	A	1.9	SH M16x2x35	
8100-32R-06	8	100	32	50	6.2	●	A	1.9	SH M16x2x35	
11100-32R-06	11	100	32	50	6.2	●	A	1.9	SH M16x2x35	
7125-40R-06	7	125	40	63	6.2	●	A	3.2	SH M20x2.5x40	
11125-40R-06	11	125	40	63	6.2	●	A	3.2	SH M20x2.5x40	
14125-40R-06	14	125	40	63	6.2	●	A	3.2	SH M20x2.5x40	
6N TF90-450-22R-09	4	50	22	40	9.2	●	A	0.3	LH M10x1.5x25	6NGU 0905...
550-22R-09	5	50	22	40	9.2	●	A	0.4	LH M10x1.5x25	E196
463-22R-09	4	63	22	40	9.2	●	A	0.5	LH M10x1.5x25	
663-22R-09	6	63	22	40	9.2	●	A	0.5	LH M10x1.5x25	
763-22R-09	7	63	22	40	9.2	●	A	0.5	LH M10x1.5x25	
580-27R-09	5	80	27	50	9.2	●	A	1.0	SH M12x1.75x35	
780-27R-09	7	80	27	50	9.2	●	A	1.1	SH M12x1.75x35	
980-27R-09	9	80	27	50	9.2	●	A	1.1	SH M12x1.75x35	
6100-32R-09	6	100	32	50	9.2	●	A	1.9	LH M16x2x35	
8100-32R-09	8	100	32	50	9.2	●	A	1.8	LH M16x2x35	
11100-32R-09	11	100	32	50	9.2	●	A	1.9	LH M16x2x35	
7125-40R-09	7	125	40	63	9.2	●	A	3.1	SH M20x2.5x40	
11125-40R-09	11	125	40	63	9.2	●	A	3.1	SH M20x2.5x40	
14125-40R-09	14	125	40	63	9.2	●	A	3.2	SH M20x2.5x40	
12160-40R-09	12	160	40	63	9.2	x	C	4.3	-	
16160-40R-09	16	160	40	63	9.2	x	C	4.3	-	
14200-60R-09	14	200	60	63	9.2	x	C	5.9	-	
18200-60R-09	18	200	60	63	9.2	x	C	5.9	-	
18250-60R-09	18	250	60	63	9.2	x	C	10.7	-	
22250-60R-09	22	250	60	63	9.2	x	C	10.8	-	



6N TF90-06/09



Торцевая фреза (дюйм)

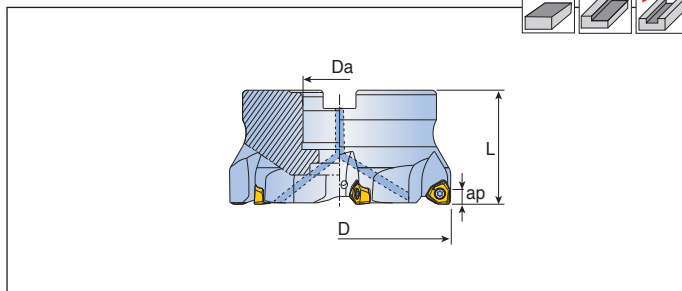
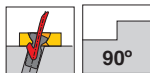
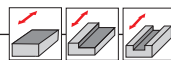

Обозначение		Размеры (мм)				Каналы СОЖ	Исполнение корпуса	Кг	Крепежный болт	Пластина
		D	Da	L	ap					
6N TF90-580-25.4R-06	5	80	25.4	50	6.2	●	A	1.0	SH M12x1.75x35	6NGU 0604... E196
780-25.4R-06	7	80	25.4	50	6.2	●	A	1.0	SH M12x1.75x35	
980-25.4R-06	9	80	25.4	50	6.2	●	A	1.0	SH M12x1.75x35	
6100-31.75R-06	6	100	31.75	50	6.2	●	B	1.9	-	
8100-31.75R-06	8	100	31.75	50	6.2	●	B	1.9	-	
11100-31.75R-06	11	100	31.75	50	6.2	●	B	1.9	-	
7125-38.1R-06	7	125	38.1	63	6.2	●	B	3.2	-	
11125-38.1R-06	11	125	38.1	63	6.2	●	B	3.2	-	
14125-38.1R-06	14	125	38.1	63	6.2	●	B	3.2	-	
6N TF90-580-25.4R-09	5	80	25.4	50	9.2	●	A	1.0	SH M12x1.75x35	6NGU 0905... E196
780-25.4R-09	7	80	25.4	50	9.2	●	A	1.1	SH M12x1.75x35	
980-25.4R-09	9	80	25.4	50	9.2	●	A	1.1	SH M12x1.75x35	
6100-31.75R-09	6	100	31.75	50	9.2	x	B	1.9	-	
8100-31.75R-09	8	100	31.75	50	9.2	x	B	1.8	-	
11100-31.75R-09	11	100	31.75	50	9.2	x	B	1.9	-	
7125-38.1R-09	7	125	38.1	63	9.2	x	B	3.1	-	
11125-38.1R-09	11	125	38.1	63	9.2	x	B	3.1	-	
14125-38.1R-09	14	125	38.1	63	9.2	x	B	3.2	-	
12160-50.8R-09	12	160	50.8	63	9.2	x	B	4.3	-	
16160-50.8R-09	16	160	50.8	63	9.2	x	B	4.3	-	

• Крепежные болты с каналом под СОЖ доступны по запросу (Пример заказа: SH M10x1.5x30-C)

Запчасти

Обозначение	Винт	Ключ			
6N TF90-04	TS 25064I	TD8	-		
6N TF90-06	TS 30085I/HG	TD9	-		
6N TF90-09	TS 40B100I	-	T-T15		

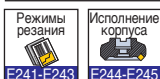

Торцевая фреза

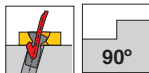
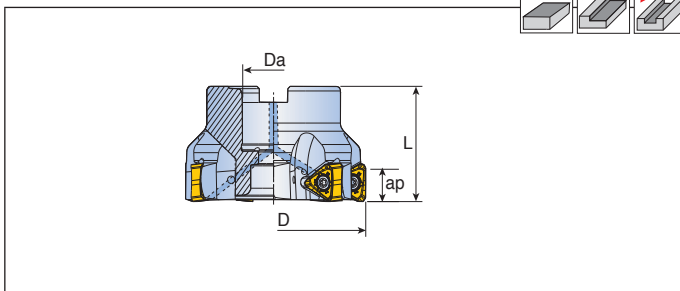
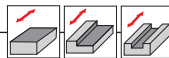

Обозначение		Размеры (мм)				Каналы СОЖ	Исполнение корпуса	Kg	Крепежный болт	Пластина	
		D	Da	L	ap						
SCRM90TN 450-16R-18	4	50	16	40	13	●	A	0.3	SH M8x1.25x30	TNMX 1806... E233	
563-22R-18	5	63	22	40	13	●	A	0.5	SH M10x1.5x30		
580-27R-18	5	80	27	50	13	●	A	1.1	SH M12x1.75x35		
780-27R-18	7	80	27	50	13	●	A	1.1	SH M12x1.75x35		
6100-32R-18-B	6	100	32	50	13	●	A	2.0	SH M16x2x35		
8100-32R-18	8	100	32	50	13	●	A	2.0	SH M16x2x35		
7125-40R-18-B	7	125	40	63	13	●	A	3.4	SH M20x2.5x40		
10125-40R-18	10	125	40	63	13	●	A	3.3	SH M20x2.5x40		
10160-40R-18	10	160	40	63	13	x	C	4.5	-		
14160-40R-18	14	160	40	63	13	x	C	4.5	-		
16200-60R-18	16	200	60	63	13	x	C	6.2	-		
SCRM90TN 350-16R-22	3	50	16	40	15	●	A	0.3	SH M8x1.25 x30	TNM(G)X 2207... E233	
463-22R-22	4	63	22	40	15	●	A	0.4	SH M10x1.25x30		
580-27R-22	5	80	27	50	15	●	A	0.9	SH M12x1.75x35		
6100-32R-22	6	100	32	50	15	●	A	1.8	SH M16x2x35		
8125-40R-22	8	125	40	63	15	●	A	3.0	SH M20x2.5x40		
10160-40R-22	10	160	40	63	15	x	C	4.2	-		
12200-60R-22	12	200	60	63	15	x	C	6	-		
14250-60R-22	14	250	60	63	15	x	C	10.6	-		



SCRM90TN



Торцевая фреза (дюйм)

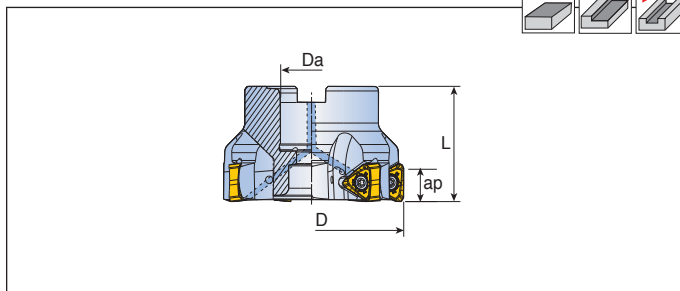
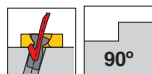
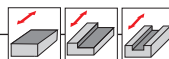

Обозначение		Размеры (мм)				Каналы СОЖ	Исполнение корпуса		Крепежный болт	Пластина
		D	Da	L	ap					
SCRM90TN 580-25.4R-18	5	80	25.4	50	13	●	A	1.1	SH M12x1.75x35	TNMX 1806...
780-25.4R-18	7	80	25.4	50	13	●	A	1.1	SH M12x1.75x35	E233
6100-31.75R-18-B	6	100	31.75	50	13	x	B	2.0	-	
8100-31.75R-18	8	100	31.75	50	13	x	B	2.0	-	
7125-38.1R-18-B	7	125	38.1	63	13	x	B	3.4	-	
10125-38.1R-18	10	125	38.1	63	13	x	B	3.3	-	
10160-50.8R-18	10	160	50.8	63	13	x	C	4.5	-	
14160-50.8R-18	14	160	50.8	63	13	x	C	4.5	-	
16200-47.625R-18	16	200	47.625	63	13	x	C	6.2	-	
SCRM90TN 580-25.4R-22	5	80	25.4	50	15	●	A	0.9	SH M12x1.75x35	TNM(G)X 2207...
6100-31.75R-22	6	100	31.75	50	15	x	B	1.8	-	E233
8125-38.1R-22	8	125	38.1	63	15	x	B	3.0	-	

• Крепежные болты с каналом под СОЖ доступны по запросу (Пример заказа: SH M10x1.5x30-C)

Запчасти

Обозначение	Винт	Ключ			
SCRM90TN-18	TS 40B100I	T-T15			
SCRM90TN-22	TS 45I20I	T-T20			



TFM90AX/2S-TFM90AP

CHASEMILL

Торцевая фреза

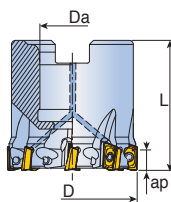
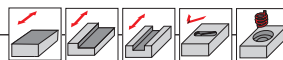

Обозначение		Размеры (мм)				Каналы СОЖ	Исполнение корпуса		Крепежный болт	Пластина
		D	Da	L	ap					
TFM90AX	832-16R-06	8	32	16	32	5.5	●	A	0.1 SH M8x1.25x25	AXM(C)T 0602...
	1040-16R-06	10	40	16	40	5.5	●	A	0.2 SH M8x1.25x25	E205
	1040-22R-06	10	40	22	40	5.5	●	A	0.2 SH M10x1.5x30	
2S-TFM90AP	540-16R-09	5	40	16	40	8.8	●	A	0.3 SH M8x1.25x30	APK(C)T 09T3...
	640-16R-09	6	40	16	40	8.8	●	A	0.2 SH M8x1.25x30	E200, E205
	550-22R-09-B	5	50	22	40	8.8	●	A	0.3 SH M10x1.5x30	
	650-22R-09	6	50	22	40	8.8	●	A	0.3 SH M10x1.5x30	
	750-22R-09	7	50	22	40	8.8	●	A	0.3 SH M10x1.5x30	
	863-22R-09	8	63	22	40	8.8	●	A	0.5 SH M10x1.5x30	
	1080-27R-09	10	80	27	50	8.8	●	A	1.1 SH M12x1.75x35	
	1080-25.4R-09	10	80	25.4	50	8.8	●	A	1.1 SH M12x1.75x35	

• Крепежные болты с каналом под СОЖ доступны по запросу (Пример заказа: SH M10x1.5x30-C)

Запчасти

Обозначение	Винт	Ключ			
TFM90AX	TS 18041I/HG	TD6P			
2S-TFM90AP	TS 25075I/HG	TD8			



TFM90AP-12/17

Торцевая фреза

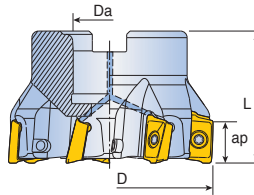
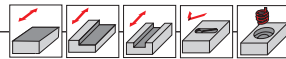

Обозначение		Размеры (мм)				Каналы СОЖ	Исполнение корпуса	Kg	Крепежный болт	Пластина
		D	Da	L	ap					
TFM90AP 440-16R-12	4	40	16	40	12	●	A	0.2	SH M8x1.25x25	APK(C)T 1204...
540-16R-12	5	40	16	40	12	●	A	0.2	SH M8x1.25x25	
550-22R-12	5	50	22	40	12	●	A	0.3	SH M10x1.5x30	
650-22R-12	6	50	22	40	12	●	A	0.3	SH M10x1.5x30	
563-22R-12	5	63	22	40	12	●	A	0.5	SH M10x1.5x30	
663-22R-12	6	63	22	40	12	●	A	0.5	SH M10x1.5x30	
763-22R-12	7	63	22	40	12	●	A	0.5	SH M10x1.5x30	
680-27R-12	6	80	27	50	12	●	A	1.0	SH M12x1.75x30	
880-27R-12	8	80	27	50	12	●	A	1.0	SH M12x1.75x30	
TFM90AP 440-16R-17	4	40	16	40	16.1	●	A	0.3	SH M8x1.25x30	APKT 1705/1706...
350-22R-17-B	3	50	22	40	16.1	●	A	0.4	SH M10x1.5x30	
450-22R-17-B	4	50	22	40	16.1	●	A	0.3	SH M10x1.5x30	
550-22R-17	5	50	22	40	16.1	●	A	0.4	SH M10x1.5x30	
463-22R-17-B	4	63	22	40	16.1	●	A	0.5	SH M10x1.5x30	
663-22R-17	6	63	22	40	16.1	●	A	0.5	SH M10x1.5x30	
480-27R-17-B	4	80	27	50	16.1	●	A	0.8	SH M12x1.75x35	
680-27R-17	6	80	27	50	16.1	●	A	0.9	SH M12x1.75x35	
780-27R-17	7	80	27	50	16.1	●	A	0.9	SH M12x1.75x35	
6100-32R-17-B	6	100	32	50	16.1	●	A	1.3	LH M16x2x35	
8100-32R-17	8	100	32	50	16.1	●	A	1.5	LH M16x2x35	
7125-40R-17-B	7	125	40	63	16.1	●	A	2.9	SH M20x2.5x40	
8125-40R-17	8	125	40	63	16.1	●	A	3.0	SH M20x2.5x40	
9125-40R-17	9	125	40	63	16.1	●	A	3.1	SH M20x2.5x40	
8160-40R-17-B	8	160	40	63	16.1	x	C	4.1	-	
10160-40R-17	10	160	40	63	16.1	x	C	4.2	-	
12200-60R-17	12	200	60	63	16.1	x	C	6.1	-	



TFM90AP-12/17

CHASEMILL

Торцевая фреза (дюйм)

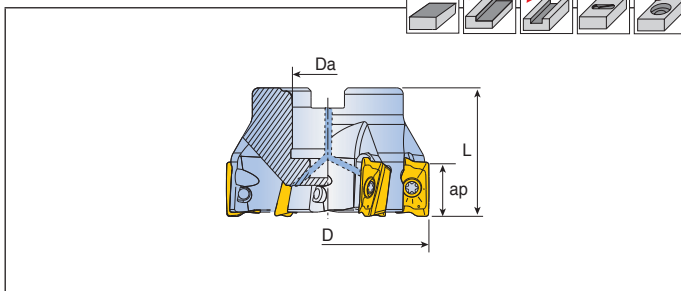
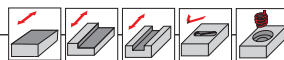

Обозначение		Размеры (мм)				Каналы СОЖ	Исполнение корпуса	Kg	Крепежный болт	Пластина
		D	Da	L	ap					
TFM90AP 880-25.4R-12	8	80	25.4	50	12	●	A	1.0	SH M12x1.75x30	APK(C)T 1204...
TFM90AP 663-25.4R-17	6	63	25.4	40	16.1	●	A	0.5	LM M12x1.75x30	APKT 1705/1706...
780-25.4R-17	7	80	25.4	50	16.1	●	A	0.9	SH M12x1.75x35	
8100-31.75R-17	8	100	31.75	50	16.1	x	B	1.5	-	
9125-38.1R-17	9	125	38.1	63	16.1	x	B	3.1	-	
10160-50.8R-17	10	160	50.8	63	16.1	x	B	4.2	-	
12200-47.625R-17	12	200	47.625	63	16.1	x	C	6.1	-	

• Крепежные болты с каналом под СОЖ доступны по запросу (Пример заказа: SH M10x1.5x30-C)

Запчасти

Обозначение	Ключ		
	Винт		
TFM90AP-12	 TS 35A088I/HG	 TD10P	 -
TFM90AP-17 (Ø40-Ø63)	TS 40093I/HG	-	T-T15
TFM90AP-17 (Ø80-)	TS 40120I/HG	-	T-T15



2S-TFM90AP-19

CHASEMILL

Торцевая фреза

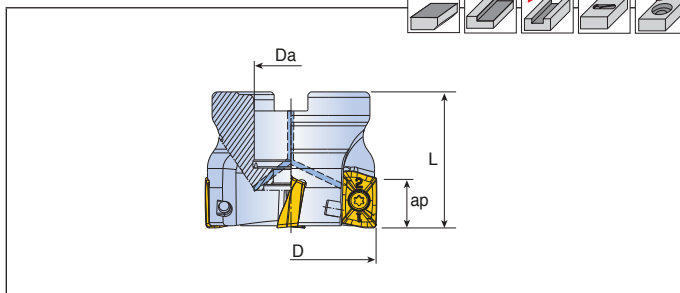
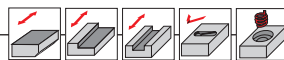

Обозначение		Размеры (мм)				Каналы СОЖ	Исполнение корпуса	кг	Крепежный болт	Пластина
		D	Da	L	ap					
2S-TFM90AP 350-22R-19	3	50	22	45	17.9	●	A	0.3	LH M10x1.5x35	АПКТ 1907...
463-22R-19	4	63	22	50	17.9	●	A	0.7	SH M10x1.5x35	E204
463-27R-19	4	63	27	50	17.9	●	A	0.7	SH M12x1.75x35	
680-27R-19	6	80	27	50	17.9	●	A	1.1	SH M12x1.75x35	
7100-32R-19	7	100	32	50	17.9	●	A	1.9	SH M16x2x35	
6125-40R-19	6	125	40	63	17.9	●	A	3.0	SH M20x2.5x40	
8125-40R-19	8	125	40	63	17.9	●	A	3.0	SH M20x2.5x40	
10160-40R-19	10	160	40	63	17.9	x	C	4.2	-	
12200-60R-19	12	200	60	63	17.9	x	C	6.1	-	

• Крепежные болты с каналом под СОЖ доступны по запросу (Пример заказа: SH M10x1.5x30-C)

Запчасти

Обозначение	Винт	Ключ			
2S-TFM90AP-19	TS 50115I	T-T20			

 Режимы резания E241-E243	 Исполнение корпуса E244-E245	 Углы врезания E262-E265
---------------------------------	-------------------------------------	--------------------------------

2P-TF90-05

Торцевая фреза

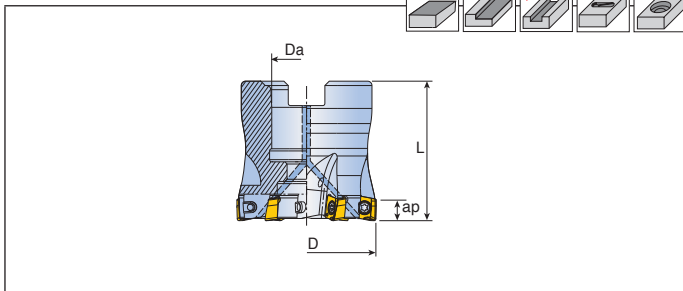
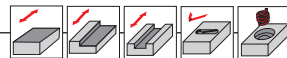

Обозначение		Размеры (мм)				Каналы СОЖ	Исполнение корпуса		Крепежный болт	Пластина
		D	Da	L	ap					
2P-TF90- 632-16R-05	6	32	16	32	4.7	●	A	0.1	SH M8x1.25x25	2PKT 0503... E192
732-16R-05	7	32	16	32	4.7	●	A	0.1	SH M8x1.25x25	
840-16R-05	8	40	16	40	4.7	●	A	0.2	SH M8x1.25x30	
840-22R-05	8	40	22	40	4.7	●	A	0.2	SH M10x1.5x30	

• Крепежные болты с каналом под СОЖ доступны по запросу (Пример заказа: SH M10x1.5x30-C)

Запчасти

Обозначение	Винт	Ключ			
	2P-TF90-05	TS 200431/HG-P	TD 6P		

Режимы резания E241-E243	Исполнение корпуса E244-E245	Углы врезания E268
-----------------------------	---------------------------------	-----------------------

TFM90AN-11/16



Торцевая фреза

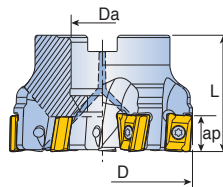
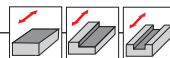

Обозначение		Размеры (мм)				Каналы СОЖ	Исполнение корпуса	Кг	Крепежный болт	Пластина
		D	Da	L	ap					
TFM90AN 440-16R-11	4	40	16	40	11	●	A	0.2	SH M8x1.25x30	ANM(H)X 1106...
450-22R-11	4	50	22	40	11	●	A	0.3	SH M10x1.5x30	
650-22R-11	6	50	22	40	11	●	A	0.3	SH M10x1.5x30	
563-22R-11	5	63	22	40	11	●	A	0.6	SH M10x1.5x30	
763-22R-11	7	63	22	40	11	●	A	0.6	SH M10x1.5x30	
880-27R-11	8	80	27	50	11	●	A	1.1	SH M12x1.75x35	
1080-27R-11	10	80	27	50	11	●	A	1.1	SH M12x1.75x35	
9100-32R-11	9	100	32	50	11	●	A	2.0	SH M16x2x35	
12100-32R-11	12	100	32	50	11	●	A	2.0	SH M16x2x35	
10125-40R-11	10	125	40	63	11	●	A	3.3	SH M20x2.5x40	
14125-40R-11	14	125	40	63	11	●	A	3.4	SH M20x2.5x40	
TFM90AN 350-22R-16	3	50	22	40	15	●	A	0.4	SH M10x1.5x30	ANM(H)X 1607...
450-22R-16	4	50	22	40	15	●	A	0.4	SH M10x1.5x30	
463-22R-16	4	63	22	40	15	●	A	0.5	SH M10x1.5x30	
663-22R-16	6	63	22	40	15	●	A	0.5	SH M10x1.5x30	
580-27R-16	5	80	27	50	15	●	A	0.8	SH M12x1.75x35	
780-27R-16	7	80	27	50	15	●	A	0.9	SH M12x1.75x35	
5100-32R-16	5	100	32	50	15	●	A	1.3	SH M16x2x35	
8100-32R-16	8	100	32	50	15	●	A	1.5	SH M16x2x35	
7125-40R-16	7	125	40	63	15	●	A	3.9	SH M20x2.5x40	
10125-40R-16	10	125	40	63	15	●	A	3.7	SH M20x2.5x40	
8160-40R-16	8	160	40	63	15	x	C	5.0	-	
12160-40R-16	12	160	40	63	15	x	C	5.3	-	
14200-60R-16	14	200	60	63	15	x	C	7.0	-	

 Режимы резания E241-E243	 Исполнение корпуса E244-E245	 Углы врезания E269
---------------------------------	-------------------------------------	---------------------------

TFM90AN-11/16

Торцевая фреза (дюйм)

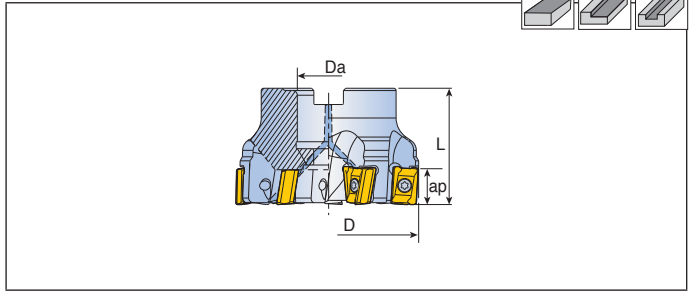

Обозначение		Размеры (мм)				Каналы СОЖ	Исполнение корпуса	кг	Крепежный болт	Пластина
		D	Da	L	ap					
TFM90AN 763-25.4R-11	7	63	25.4	40	11	●	A	0.6	LH M12x1.75x30	ANM(H)X 1106...
880-25.4R-11	8	80	25.4	50	11	●	A	1.1	SH M12x1.75x35	E199
1080-25.4R-11	10	80	25.4	50	11	●	A	1.1	SH M12x1.75x35	
TFM90AN 580-25.4R-16	5	80	25.4	50	15	●	A	0.8	SH M12x1.75x35	ANM(H)X 1607...
780-25.4R-16	7	80	25.4	50	15	●	A	0.9	SH M12x1.75x35	E199
5100-31.75R-16	5	100	31.75	50	15	x	B	1.3	-	
8100-31.75R-16	8	100	31.75	50	15	x	B	1.5	-	
7125-38.1R-16	7	125	38.1	63	15	x	B	3.9	-	
10125-38.1R-16	10	125	38.1	63	15	x	B	3.7	-	
8160-50.8R-16	8	160	50.8	63	15	x	C	5.0	-	

• Крепежные болты с каналом под СОЖ доступны по запросу (Пример заказа: SH M10x1.5x30-C)

Запчасти

Обозначение	Винт	Ключ			
TFM90AN-11	TS 35A088I/HG	TD10P	-		
TFM90AN-16	TS 40120I	-	T-T15		

 Режимы резания E241-E243	 Исполнение корпуса E244-E245	 Углы врезания E269
---------------------------------	-------------------------------------	---------------------------

4N TF90-06



Торцевая фреза

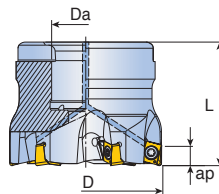
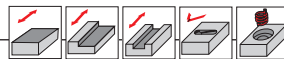

Обозначение		Размеры (мм)				Каналы СОЖ	Исполнение корпуса		Крепежный болт	Пластина
		D	Da	L	ap					
4N TF90-432-16R-06	4	32	16	32	6	●	A	0.1	SH M8x1.25x25	4NKT 0603...
532-16R-06	5	32	16	32	6	●	A	0.1	SH M8x1.25x25	
540-16R-06	5	40	16	40	6	●	A	0.3	SH M8x1.25x25	
640-16R-06	6	40	16	40	6	●	A	0.3	SH M8x1.25x25	
650-22R-06	6	50	22	40	6	●	A	0.4	SH M10x1.5x30	
750-22R-06	7	50	22	40	6	●	A	0.4	SH M10x1.5x30	
763-22R-06	7	63	22	40	6	●	A	0.6	SH M10x1.5x30	
863-22R-06	8	63	22	40	6	●	A	0.6	SH M10x1.5x30	

- Параметры ap и L относятся к пластинам с радиусом 08R
- Корпус фрезы для пластины '4NKT 06' с радиусом при вершине более чем 1.6 мм должен быть доработан таким образом, чтобы R(корпуса)=R(пластины)-0.2mm
- Крепежные болты с каналом под СОЖ доступны по запросу (Пример заказа: SH M10x1.5x30-C)

Запчасти

Обозначение	Винт	Ключ			
4N TF90-06	TS 30B068I/HG	TD 8			

 Режимы резания E241-E243	 Исполнение корпуса E244-E245	 Углы врезания E270
---------------------------------	-------------------------------------	---------------------------

Торцевая фреза

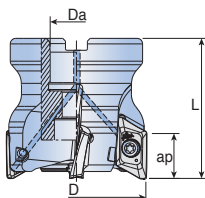
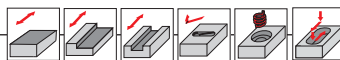

Обозначение		Размеры (мм)				Каналы СОЖ	Исполнение корпуса	Max RPM	Kg	Крепежный болт	Пластина
		D	Da	L	ap						
TFM90XEV 340-16R-16	3	40	16	50	16	●	A	41,200	0.2	SH M8x1.25x35-C	XEVT 1605...
450-22R-16	4	50	22	50	16	●	A	36,800	0.3	SH M10x1.5x30-C	
563-22R-16	5	63	22	50	16	●	A	32,700	0.5	SH M10x1.5x30-C	
580-27R-16	5	80	27	50	16	●	A	29,000	0.9	LH M12x1.75x30-C	
680-27R-16	6	80	27	50	16	●	A	29,000	0.8	LH M12x1.75x30-C	
6100-32R-16	6	100	32	63	16	●	A	26,000	1.6	SH M16X2x35-C	
7125-40R-16	7	125	40	63	16	●	A	23,200	2.5	SH M20x2.5x40-C	
8160-40R-16	8	160	40	63	16	x	C	20,000	3.8	-	
10200-60R-16	10	200	60	63	16	x	C	18,300	5.3	-	
TFM90XEV 350-22R-22	3	50	22	55	21	●	A	31,400	0.4	SH M10x1.5x30-C	
463-22R-22	4	63	22	55	21	●	A	28,000	0.6	SH M10x1.5x30-C	
580-27R-22	5	80	27	55	21	●	A	24,800	1	LH M12x1.75x30-C	
6100-32R-22	6	100	32	63	21	●	A	22,200	2.1	SH M16x2x35-C	
7125-40R-22	7	125	40	63	21	●	A	19,900	2.8	SH M20x2.5x40-C	
10200-60R-22	10	200	60	63	21	x	C	15,700	5.9	-	

• Корпус фрезы для пластины 3.2мм (XEVT 16), 3.0мм (XEVT 22) должен быть доработан таким образом, чтобы R(корпуса)=R(пластины)-0,3 мм

Запчасти

Обозначение	Винт	Ключ			
	TFM90XEV-16	TS 400931/HG	T-T15		
TFM90XEV-22	TS 501151	T-T20			



TFM90SNS-12

Торцевая фреза: для отделки

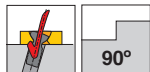
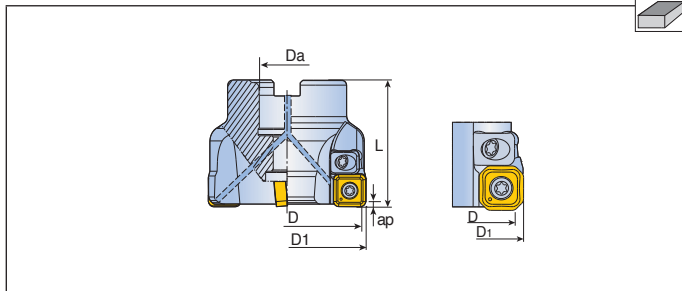

Обозначение	Z	Размеры (мм)					Каналы СОЖ	Исполнение корпуса	Kg	Крепежный болт	Пластина
		D	D1	Da	L	ap					
TFM90SNS 350-22R-12	3	43.35	50	22	50	1	●	A	0.5	SH M10x1.5x40	SNEX 1204... SNET 1205... E224
463-22R-12	4	56.35	63	22	50	1	●	A	0.7	SH M10x1.5x40	
680-27R-12	6	73.35	80	27	50	1	●	A	1.0	SH M12x1.75x35	
8100-32R-12	8	93.35	100	32	63	1	●	A	2.0	SH M16x2x30	
12100-32R-12	12	93.35	100	32	63	1	●	A	2.0	SH M16x2x30	
10125-40R-12	10	118.35	125	40	63	1	x	B	2.9	-	
16125-40R-12	16	118.35	125	40	63	1	x	B	2.9	-	
12160-40R-12	12	153.35	160	40	63	1	x	C	4.4	-	
20160-40R-12	20	153.35	160	40	63	1	x	C	4.4	-	
16200-60R-12	16	193.35	200	60	63	1	x	C	6.0	-	
24200-60R-12	24	193.35	200	60	63	1	x	C	6.0	-	
30250-60R-12	30	243.35	250	60	63	1	x	C	10.8	-	

• Рекомендуется для хороших условий резания стали и чугуна

Запчасти

Обозначение	Винт	Рег. клин	Рег. винт	Ключ	
TFM90SNS-12	TS 35C110I	AJS 1010R	AWS 0620	T-T15	

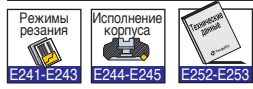

Быстросменный корпус торцевой фрезы: для отделки

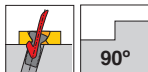
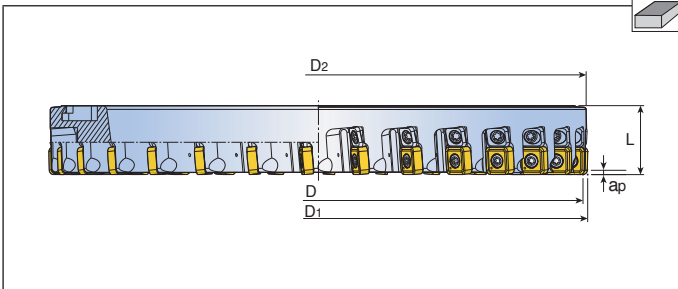

Обозначение		Размеры (мм)						Адаптер	Пластина
		D	D1	D2	L	ap			
TFM90SNS 20250-12-QC	20	243.35	250	248.59	32	1	3.6	TQCA D250	SNEX 1204... SNET 1205... E224
30250-12-QC	30	243.35	250	248.59	32	1	3.6	TQCA D250	
24315-12-QC	24	308.35	315	313	38	1	8.1	TQCA D315	
36315-12-QC	36	308.35	315	313	38	1	8.1	TQCA D315	
28355-12-QC	28	348.35	355	353	38	1	9.2	TQCA D355	
42355-12-QC	42	348.35	355	353	38	1	9.2	TQCA D355	
32400-12-QC	32	393.35	400	398	38	1	10.5	TQCA D400	
48400-12-QC	48	393.35	400	398	38	1	10.6	TQCA D400	

• Рекомендуется для хороших условий резания стали и чугуна

Запчасти

Обозначение					
TFM90SNS-12-QC	TS 35C110I	AJS 1010R	AWS 0620	T-T15	



TQ90SNS-12

Быстросменный корпус торцевой фрезы: для отделки

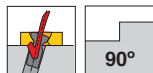
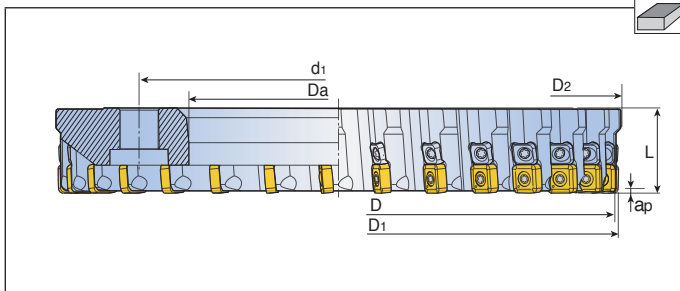

Обозначение		Размеры (мм)								Адаптер	Пластина
		D	D1	D2	Da	d1	L	ap			
TQ90SNS 20250R-12	20	243.35	250	253	133.35	177.8	38	1	7.5	QA 10 K/M	SNEX 1204... SNET 1205... E224
30250R-12	30	243.35	250	253	133.35	177.8	38	1	7.5	QA 10 K/M	
36315R-12	36	308.35	315	317	146.05	215.9	38	1	14.0	QA 12 K/M	
28355R-12	28	348.35	355	357	215.9	260.4	38	1	12.8	QA 14 K/M	
42355R-12	42	348.35	355	357	215.9	260.4	38	1	12.8	QA 14 K/M	
32400R-12	32	393.35	400	402	254	304.8	38	1	16.0	QA 16 K/M	

• Рекомендуется для хороших условий резания стали и чугуна

Запчасти

Обозначение	Винт 	Рег. клин 	Рег. винт 	Ключ 	
TQ90SNS	TS 35C110I	AJS 1010R	AWS 0620	T-T15	



LM90TP-22

LIONMILL

Торцевая фреза

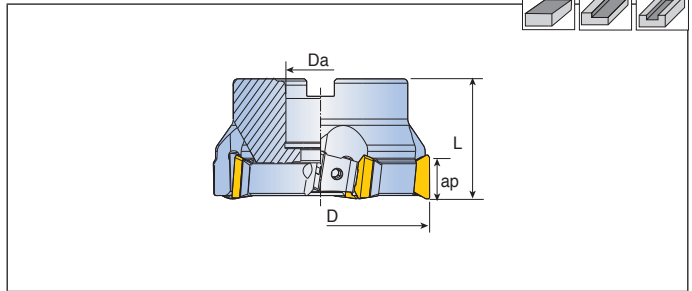

Обозначение		Размеры (мм)				Исполнение корпуса	Kg	Крепежный болт	Пластина
		D	Da	L	ap				
LM90TP 480-25.4R-22	4	80	25.4	50	17.6	A	1.2	SH M12x1.75x35	TPKN 2204... E234
5100-31.75R-22	5	100	31.75	55	17.6	A	2.2	SH M16x2x35	
6125-38.1R-22	6	125	38.1	63	17.6	B	3.0	-	
8160-50.8R-22	8	160	50.8	63	17.6	B	4.7	-	
10200-47.625R-22	10	200	47.625	63	17.6	C	6.4	-	
12250-47.625R-22	12	250	47.625	63	17.6	C	10.7	-	
14315-47.625R-22	14	315	47.625	63	17.6	D	16.7	-	

• Метрическое исполнение корпусов доступно по запросу

Запчасти

Обозначение	Опорная пластина 	Клин 	Винт опорной пластины 	Винт клина 	Ключ 	Ключ винта прокладки
LM90TP-22	TSTP 22N	WPA 8	TS 40B100I	TS 80200W TS 80160W ⁽¹⁾	T-W4	T-T15 ⁽²⁾

Режимы резания
 E241-E243

Исполнение корпуса
 E244-E245

- ⁽¹⁾TS 80160W для фрезы D80
- Ключ винта опорной пластины T-T15⁽²⁾ заказывается отдельно

LM90SE-21

Торцевая фреза

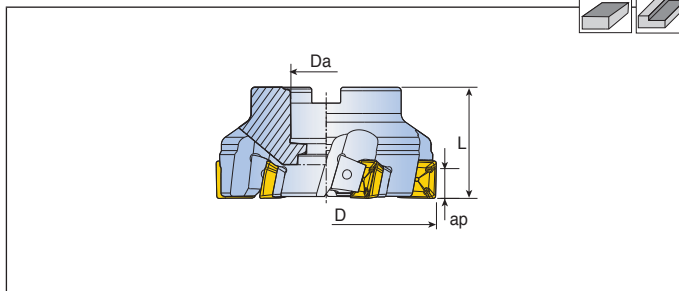
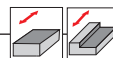

Обозначение		Размеры (мм)				Исполнение корпуса	кг	Крепежный болт	Пластина
		D	Da	L	ap				
LM90SE 6125-40R-21	6	125	40	63	17	A	3.4	SH M20x2.5x40	SEKX 2107...
8160-40R-21	8	160	40	63	17	C	5.3	-	E222
10200-60R-21	10	200	60	80	17	C	9.6	-	
12200-60R-21	12	200	60	80	17	C	9.5	-	
12250-60R-21	12	250	60	80	17	C	16.4	-	
14250-60R-21	14	250	60	80	17	C	16.4	-	
12315-60R-21	12	315	60	80	17	D	21.0	-	
16315-60R-21	16	315	60	80	17	D	20.7	-	
LM90SE 6125-38.1R-21	6	125	38.1	63	17	B	3.4	-	
8160-50.8R-21	8	160	50.8	63	17	B	5.3	-	
10200-47.625R-21	10	200	47.625	80	17	C	9.6	-	
12200-47.625R-21	12	200	47.625	80	17	C	9.5	-	
12250-47.625R-21	12	250	47.625	80	17	C	16.4	-	
14250-47.625R-21	14	250	47.625	80	17	C	16.4	-	
12315-47.625R-21	12	315	47.625	80	17	D	21.0	-	
16315-47.625R-21	16	315	47.625	80	17	D	20.7	-	

Запчасти

Обозначение	Опорная пластина	Винт опорной пластины	Клин	Винт клина	Ключ	Ключ винта прокладки ⁽¹⁾
LM90SE-21	TSSE 21N-ST	TS 50C130I/HG	WPA 8-SE16	TS 80160W TS 80200W	T-W4	T-T20 ⁽¹⁾



- Ключ винта опорной пластины⁽¹⁾ заказывается отдельно
- Ключ винта TS 80160W : Диаметр 125 – 200 мм
TS 80200W : Диаметр 250 – 315 мм

TFM90SN/TFM88SN-13

Торцевая фреза

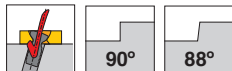
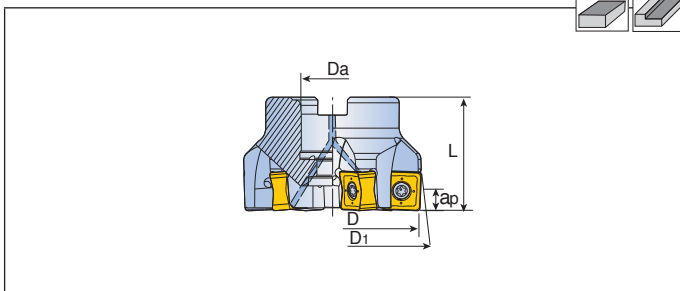

Обозначение		Размеры (мм)					Каналы СОЖ	Исполнение корпуса	кг	Крепежный болт	Пластина
		D	D ₁	D _a	L	ap					
TFM90SN 550-22R-13	5	50	50.7	22	40	12	●	A	0.3	SH M10x1.5x30	SNGX 1306 ... E226
663-22R-13	6	63	63.7	22	40	12	●	A	0.5	SH M10x1.5x30	
780-27R-13	7	80	80.7	27	50	12	●	A	1.2	SH M12x1.75x35	
980-27R-13*	9	80	80.7	27	50	12	●	A	1.2	SH M12x1.75x35	
8100-32R-13	8	100	100.8	32	50	12	●	A	1.9	SH M16x2x30	
13100-32R-13*	13	100	100.8	32	50	12	●	A	1.9	SH M16x2x30	
10125-40R-13	10	125	125.8	40	63	12	x	B	2.8	-	
16125-40R-13*	16	125	125.8	40	63	12	x	B	2.8	-	
TFM88SN 550-22R-13	5	50	51.2	22	40	12	●	A	0.3	SH M10x1.5x30	SNGX 1306 ZN... E226
663-22R-13	6	63	64.2	22	40	12	●	A	0.5	SH M10x1.5x30	
780-27R-13	7	80	81.2	27	50	12	●	A	1.2	SH M12x1.75x35	
980-27R-13*	9	80	81.2	27	50	12	●	A	1.2	SH M12x1.75x35	
8100-32R-13	8	100	101.2	32	50	12	●	A	1.9	SH M16x2x30	
11100-32R-13*	11	100	101.2	32	50	12	●	A	1.9	SH M16x2x30	
10125-40R-13	10	125	126.1	40	63	12	x	B	2.8	-	
14125-40R-13*	14	125	126.1	40	63	12	x	B	2.8	-	
12160-40R-13	12	160	161.1	40	63	12	x	C	4.2	-	
18160-40R-13*	18	160	161.1	40	63	12	x	C	4.2	-	
14200-60R-13	14	200	201.1	60	63	12	x	C	6.0	-	
22200-60R-13*	22	200	201.1	60	63	12	x	C	6.0	-	

Режимы резания E241-E243

Исполнение корпуса E244-E245

- *: Фреза с мелким шагом для чугуна
- Крепежные болты с каналом под СОЖ доступны по запросу (Пример заказа: SH M10x1.5x30-C)

TFM90SN/TFM88SN-13

Торцевая фреза (дюйм)

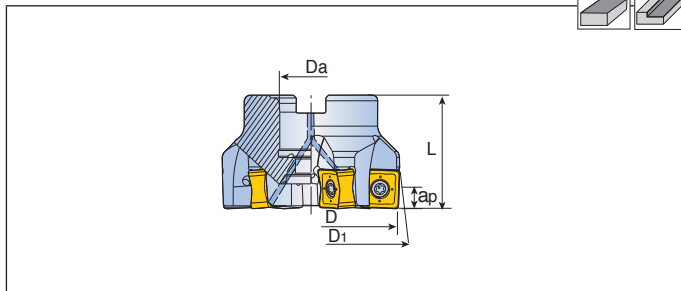
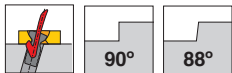

Обозначение		Размеры (мм)					Каналы СОЖ	Исполнение корпуса	Кг	Крепежный болт	Пластина
		D	D1	Da	L	ap					
TFM90SN 780-25.4R-13	7	80	80.7	25.4	50	12	●	A	1.2	SH M12x1.75x35	SNGX 1306 ...
980-25.4R-13*	9	80	80.7	25.4	50	12	●	A	1.2	SH M12x1.75x35	E226
8100-31.75R-13*	8	100	100.8	31.75	50	12	x	B	1.9	-	-
13100-31.75R-13*	13	100	100.8	31.75	50	12	x	B	1.9	-	-
10125-38.1R-13	10	125	125.8	38.1	63	12	x	B	2.8	-	-
TFM88SN 780-25.4R-13	7	80	81.2	25.4	50	12	●	A	1.2	SH M12x1.75x35	SNGX 1306 ZN...
980-25.4R-13*	9	80	81.2	25.4	50	12	●	A	1.2	SH M12x1.75x35	E226
8100-31.75R-13	8	100	101.2	31.75	50	12	x	B	1.9	-	-
11100-31.75R-13*	11	100	101.2	31.75	50	12	x	B	1.9	-	-
10125-38.1R-13	10	125	126.1	38.1	63	12	x	B	2.8	-	-
12160-50.8R-13	12	160	161.1	50.8	63	12	x	C	4.2	-	-
14200-47.625R-13	14	200	201.1	47.625	63	12	x	C	6.0	-	-

- *: Фреза с мелким шагом для чугуна
- Крепежные болты с каналом под СОЖ доступны по запросу (Пример заказа: SH M10x1.5x30-C)

Запчасти

Обозначение	Винт 	Ключ 				
TFM90SN	TS 40B100I	T-T15				
TFM88SN	TS 40B100I	T-T15				

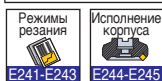

TFM75SN-13

Торцевая фреза

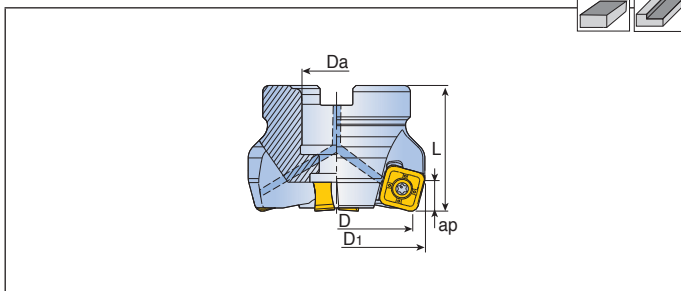

Обозначение		Размеры (мм)					Каналы СОЖ	Исполнение корпуса	Kg	Крепежный болт	Пластина
		D	D1	Da	L	ap					
TFM75SN 450-22R-13	4	50	55.4	22	40	9.5	●	A	0.4	LH M10x1.5x25	SNM(G)X 1306 EN... SNMX 1306 XTN... E225
650-22R-13	6	50	55.4	22	40	9.5	●	A	0.4	LH M10x1.5x25	
663-22R-13	6	63	68.4	22	40	9.5	●	A	0.6	LH M10x1.5x25	
863-22R-13	8	63	68.4	22	40	9.5	●	A	0.6	LH M10x1.5x25	
780-27R-13	7	80	85.4	27	50	9.5	●	A	1.3	LH M12x1.75x30	
1080-27R-13	10	80	85.4	27	50	9.5	●	A	1.3	LH M12x1.75x30	
8100-32R-13	8	100	105.4	32	50	9.5	●	A	1.9	LH M16x2x35	
12100-32R-13	12	100	105.4	32	50	9.5	●	A	2.0	LH M16x2x35	
10125-40R-13	10	125	130.3	40	63	9.5	●	A	3.2	SH M20x2.5x40	
16125-40R-13	16	125	130.4	40	63	9.5	●	A	3.3	SH M20x2.5x40	
12160-40R-13	12	160	165.3	40	63	9.5	x	C	4.7	-	
20160-40R-13	20	160	165.4	40	63	9.5	x	C	4.8	-	
16200-60R-13	16	200	205.3	60	63	9.5	x	C	6.4	-	
22200-60R-13	22	200	205.4	60	63	9.5	x	C	6.4	-	
20250-60R-13	20	250	255.3	60	63	9.5	x	C	11.7	-	
TFM75SN 580-25.4R-13B	5	80	85.4	25.4	50	9.5	●	A	1.3	LH M12x1.75x30	
1080-25.4R-13	10	80	85.4	25.4	50	9.5	●	A	1.5	LH M12x1.75x30	
6100-31.75R-13B	6	100	105.4	31.75	50	9.5	x	B	1.9	-	
8125-38.1R-13B	8	125	130.3	38.1	63	9.5	x	B	3.2	-	
12160-50.8R-13B	12	160	165.3	50.8	63	9.5	x	B	4.7	-	

• Крепежные болты с каналом под СОЖ доступны по запросу (Пример заказа: SH M10x1.5x30-C)

Запчасти

Обозначение	Винт	Ключ			
	TFM75SN	TS 40B100I	T-T15		



LM75SP-12/15

LIONMILL

Торцевая фреза

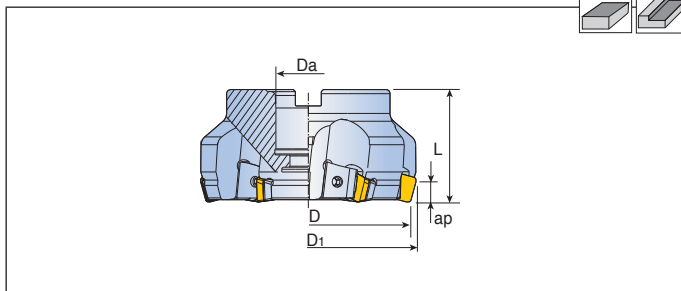

Обозначение		Размеры (мм)					Исполнение корпуса		Крепежный болт	Пластина
		D	D1	Da	L	ap				
LM75SP 580-25.4 R-12	5	80	85.4	25.4	50	9.5	A	1.5	SH M12x1.75x35	SPKN 1203...
6100-31.75R-12	6	100	105.4	31.75	55	9.5	A	2.4	LH M16x2x35	E229
8125-38.1R-12	8	125	130.4	38.1	63	9.5	B	3.2	-	
10160-50.8R-12	10	160	165.4	50.8	63	9.5	B	5.0	-	
12200-47.625R-12	12	200	205.4	47.625	63	9.5	C	6.9	-	
16250-47.625R-12	16	250	255.4	47.625	63	9.5	C	11.3	-	
20315-47.625R-12	20	315	320.4	47.625	63	9.5	D	17.6	-	
LM75SP 580-25.4R-15	5	80	86.97	25.4	55	12.5	A	1.5	SH M12x1.75x35	SPKN 1504...
5100-31.75R-15	5	100	106.96	31.75	55	12.5	A	2.4	LH M16x2x35	E229
8125-38.1R-15	8	125	131.95	38.1	63	12.5	B	3.1	-	
10160-50.8R-15	10	160	166.94	50.8	63	12.5	B	5.0	-	
12200-47.625R-15	12	200	206.94	47.625	63	12.5	C	6.9	-	
16250-47.625R-15	16	250	256.93	47.625	63	12.5	C	10.78	-	
20315-47.625R-15	20	315	321.93	47.625	63	12.5	D	16.88	-	

• Метрическое исполнение корпусов доступно по запросу

Запчасти

Обозначение	Твердосплавная опорная пластина	Клин	Винт опорной пластины	Винт клина	Ключ	Ключ винта прокладки
LM75SP-12	TSSP 12N	WPA 8	TS 40B100I	TS 80200W	T-W4	T-T15
LM75SP-15	TSSP 15N	WPA 8	TS 40B100I	TS 80160W ⁽¹⁾	T-W4	T-T15



- ⁽¹⁾ Винт клина TS 80160W для фрезы D80
- Ключ винта опорной пластины T-T15⁽²⁾ заказывается отдельно

TFM75AP-17

Торцевая фреза

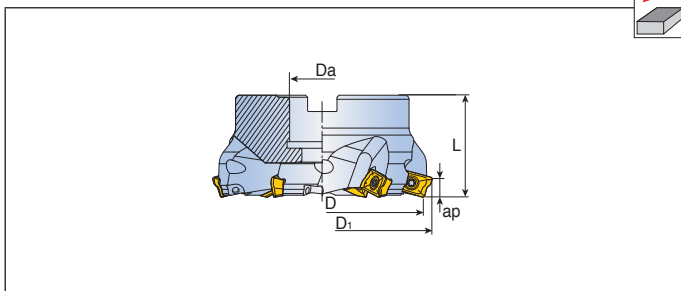

Обозначение		Размеры (мм)					Исполнение корпуса		Крепежный болт	Пластина
		D	D ₁	D _a	L	ap				
TFM75AP 580-27R-17	5	80	87.82	27	50	3.9	A	0.8	SH M12x1.75x35	APKT 1705 PER-M APKT 1705 PER-EM E203
6100-32R-17	6	100	107.82	32	50	3.9	B	1.3	-	
7125-40R-17	7	125	132.82	40	63	3.9	B	3.5	-	
580-25.4R-17	5	80	87.82	25.4	50	3.9	A	0.8	SH M12x1.75x35	
TFM75AP 6100-31.75R-17	6	100	107.82	31.75	50	3.9	B	1.3	-	
7125-38.1R-17	7	125	132.82	38.1	63	3.9	B	3.5	-	

• Корпус фрезы для "тупого" угла пластин APKT

Запчасти

Обозначение	Винт	Ключ			
TFM75AP-17	TS 40120/HG	T-T15			

Режимы резания

E241-E243

Исполнение корпуса



E244-E245

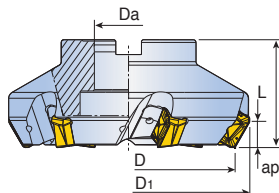
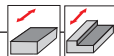

LM60SC-21

Торцевая фреза



60°

Обозначение		Размеры (мм)					Исполнение корпуса	 Kg	Пластина
		D	D1	Da	L	ap			
LM60SC 5125-40R-21	5	125	141.2	40	63	13	B	4.1	SCKN 2107...  E221
8125-40R-21	8	125	141.2	40	63	13	B	4.1	
8160-40R-21	8	160	176.1	40	63	13	C	6.5	
10160-40R-21	10	160	176.1	40	63	13	C	6.4	
10200-60R-21	10	200	216.1	60	80	13	C	11.8	
12200-60R-21	12	200	216.1	60	80	13	C	11.8	
12250-60R-21	12	250	266	60	80	13	C	19.2	
14250-60R-21	14	250	266	60	80	13	C	19.1	
16250-60R-21	16	250	266	60	80	13	C	19.1	
12315-60R-21	12	315	331	60	80	13	D	25.0	
16315-60R-21	16	315	331	60	80	13	D	25.0	
18315-60R-21	18	315	331	60	80	13	D	25.0	

 Режимы резания
E241-E243
 Исполнение корпуса
E244-E245

LM60SC-21

LIONMILL

Торцевая фреза (дюйм)

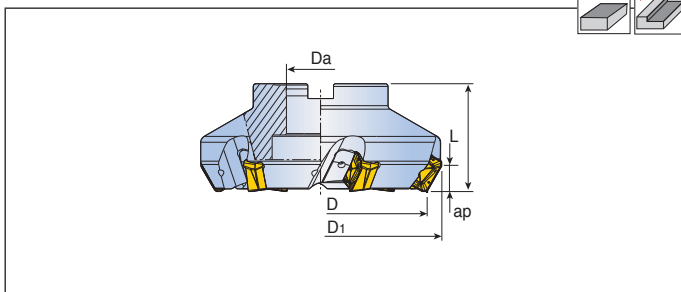

Обозначение		Размеры (мм)					Исполнение корпуса		Пластина
		D	D1	Da	L	ap			
LM60SC 5125-38.1R-21	5	125	141.2	38.1	63	13	B	4.1	SCKN 2107... E221
8160-50.8R-21	8	160	176.1	50.8	63	13	B	6.5	
10160-50.8R-21	10	160	176.1	50.8	63	13	B	6.4	
10200-47.625R-21	10	200	216.1	47.625	80	13	C	11.8	
12200-47.625R-21	12	200	216.1	47.625	80	13	C	11.8	
12250-47.625R-21	12	250	266	47.625	80	13	C	19.2	
14250-47.625R-21	14	250	266	47.625	80	13	C	19.1	
16250-47.625R-21	16	250	266	47.625	80	13	C	19.1	
12315-47.625R-21	12	315	331	47.625	80	13	D	25.0	
16315-47.625R-21	16	315	331	47.625	80	13	D	25.0	
18315-47.625R-21	18	315	331	47.625	80	13	D	25.0	

Запчасти

Обозначение	Опорная пластина	Винт опорной пластины	Клин	Винт клина	Ключ	Ключ винта прокладки ⁽¹⁾
LM60SC-21	TSSC 21R-ST	TS 50C1301/HG	WSC 8R-21	TS 80200W	T-W4	T-T20

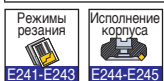

• Ключ винта опорной пластины ⁽¹⁾ заказывается отдельно

LM60SC-27

Торцевая фреза

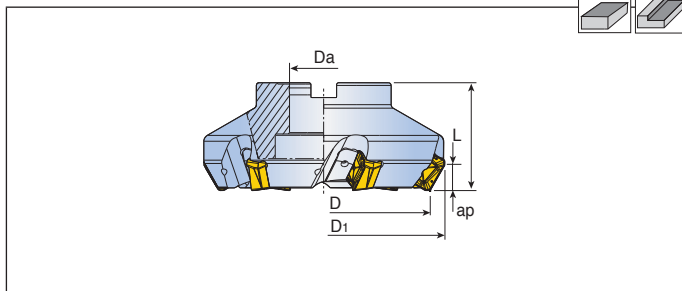
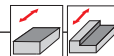

Обозначение		Размеры (мм)					Исполнение корпуса	Kg	Пластина
		D	D1	Da	L	ap			
LM60SC 5125-40R-27	5	125	146	40	63	18	B	4.6	SCKN 2108... E221
6160-40R-27	6	160	181	40	80	18	C	8.7	
8160-40R-27	8	160	181	40	80	18	C	8.4	
8200-60R-27	8	200	220.9	60	80	18	C	12.4	
10200-60R-27	10	200	220.9	60	80	18	C	12.3	
10250-60R-27	10	250	270.8	60	80	18	C	19.9	
12250-60R-27	12	250	270.8	60	80	18	C	19.8	
12315-60R-27	12	315	335.8	60	80	18	D	26.0	
15315-60R-27	15	315	335.8	60	80	18	D	25.9	
15400-60R-27*	15	400	420.9	60	80	18	D	44.0	
19400-60R-27*	19	400	420.9	60	80	18	D	43.0	
24500-60R-27*	24	500	520.9	60	80	18	D	64.0	

Режимы резания E241-E243

Исполнение корпуса E244-E245

• *: Доступно по запросу

Торцевая фреза (дюйм)

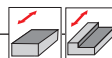
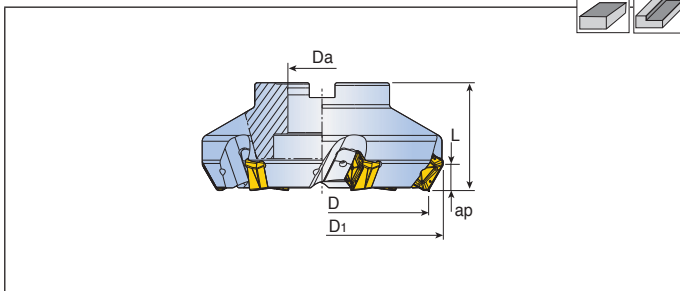

Обозначение		Размеры (мм)					Исполнение корпуса		Пластина
		D	D1	Da	L	ap			
LM60SC 5125-38.1R-27	5	125	146	38.1	63	18	B	4.6	SCKN 2108... E221
6160-50.8R-27	6	160	181	50.8	80	18	B	8.7	
8160-50.8R-27	8	160	181	50.8	80	18	B	8.4	
8200-47.625R-27	8	200	220.9	47.625	80	18	C	12.4	
10200-47.625R-27	10	200	220.9	47.625	80	18	C	12.3	
10250-47.625R-27	10	250	270.8	47.625	80	18	C	19.9	
12250-47.625R-27	12	250	270.8	47.625	80	18	C	19.8	
12315-47.625R-27	12	315	335.8	47.625	80	18	D	26.0	
15315-47.625R-27	15	315	335.8	47.625	80	18	D	25.9	

Запчасти

Обозначение	Опорная пластина	Винт опорной пластины	Клин	Винт клина	Ключ	Ключ винта прокладки
LM60SC-27	TSSC 27R-ST	TS 60A130I	WSC 8R	TS 80200W	T-W4	BLD T25/M7+SW6-T1

Режимы резания E241-E243

Исполнение корпуса E244-E245

• Ключ винта опорной пластины ⁽¹⁾ заказывается отдельно

TFM55AHNS-05

Торцевая фреза

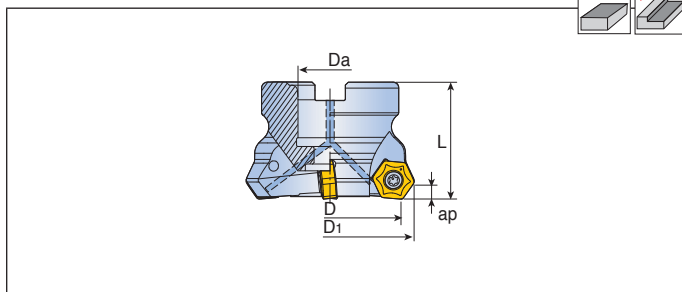
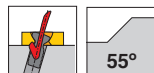

Обозначение	Z	Размеры (мм)					Каналы СОЖ	Исполнение корпуса	Kg	Крепежный болт	Пластина
		D	D1	Da	L	ap					
TFM55AHNS 450-22R-05B	4	50	58.16	22	40	5	●	A	0.4	SH M10x1.5x30	HNC(M)X 05...
650-22R-05	6	50	58.16	22	40	5	●	A	0.4	SH M10x1.5x30	E209
563-22R-05B	5	63	71.16	22	40	5	●	A	0.6	SH M10x1.5x30	
863-22R-05	8	63	71.16	22	40	5	●	A	0.5	SH M10x1.5x30	
680-27R-05B	6	80	88.16	27	50	5	●	A	1.3	SH M12x1.75x35	
880-27R-05	8	80	88.16	27	50	5	●	A	1.2	SH M12x1.75x35	
1080-27R-05	10	80	88.16	27	50	5	●	A	1.2	SH M12x1.75x35	
7100-32R-05B	7	100	108.16	32	50	5	●	A	2.0	SH M16x2x35	
10100-32R-05	10	100	108.16	32	50	5	●	A	2.0	SH M16x2x35	
12100-32R-05	12	100	108.16	32	50	5	●	A	2.0	SH M16x2x35	
10125-40R-05B	10	125	133.16	40	63	5	●	A	3.2	SH M20x2.5x40	
12125-40R-05	12	125	133.16	40	63	5	●	A	3.4	SH M20x2.5x40	
16125-40R-05	16	125	133.16	40	63	5	●	A	3.2	SH M20x2.5x40	
12160-40R-05B	12	160	168.16	40	63	5	x	C	4.7	-	
TFM55AHNS 680-25.4R-05B	6	80	88.16	25.4	50	5	●	A	1.3	SH M12x1.75x35	
7100-31.75R-05B	7	100	108.16	31.75	50	5	x	B	2.0	-	
10125-38.1R-05B	10	125	133.16	38.1	63	5	x	B	3.2	-	
12160-50.8R-05B	12	160	168.16	50.8	63	5	x	B	4.7	-	

• Крепежные болты с каналом под СОЖ доступны по запросу (Пример заказа: SH M10x1.5x30-C)

Запчасти

Обозначение	Винт	Ключ			
TFM55AHNS	TS 40B100I	T-T15			

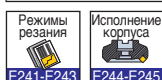

14D-F45XN-06

Торцевая фреза

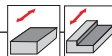
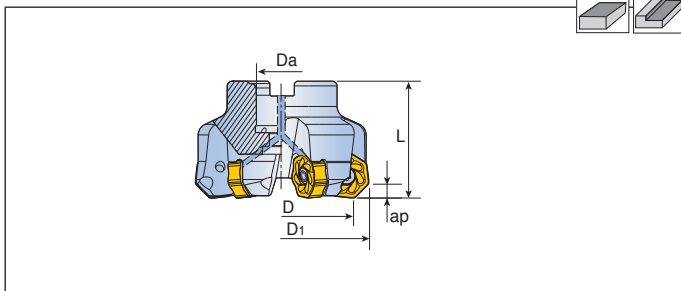

Обозначение		Размеры (мм)					Каналы СОЖ	Исполнение корпуса	кг	Крепежный болт	Пластина
		D	D ₁	Da	L	ap					
14D-F45XN 550-22R-06	5	50	59.1	22	40	3.5	●	A	0.4	LH M10x1.5x25	XNM(H)U 0605... E237
563-22R-06	5	63	72.1	22	50	3.5	●	A	0.8	SH M10x1.5x25	
763-22R-06	7	63	72.1	22	50	3.5	●	A	0.8	SH M10x1.5x25	
680-27R-06	6	80	89.1	27	50	3.5	●	A	1.4	SH M12x1.75x35	
980-27R-06	9	80	89.1	27	50	3.5	●	A	1.4	SH M12x1.75x35	
7100-32R-06	7	100	109.1	32	50	3.5	●	A	2.1	SH M16x2x35	
11100-32R-06	11	100	109.1	32	50	3.5	●	A	2.1	SH M16x2x35	
10125-40R-06	10	125	134.1	40	63	3.5	●	A	3.6	SH M20x2.5x40	
14125-40R-06	14	125	134.1	40	63	3.5	●	A	3.6	SH M20x2.5x40	
12160-40R-06	12	160	169.1	40	63	3.5	x	C	4.7	-	
16160-40R-06	16	160	169.1	40	63	3.5	x	C	4.9	-	
18160-40R-06	18	160	169.1	40	63	3.5	x	C	5.0	-	
14D-F45XN 763-25.4R-06	7	63	72.1	25.4	50	3.5	●	A	0.8	SH M12x1.75x30	
980-25.4R-06	9	80	89.1	25.4	50	3.5	●	A	1.4	SH M12x1.75x35	
11100-31.75R-06	11	100	109.1	31.75	50	3.5	●	A	1.9	LH M16x2x35	
14125-38.1R-06	14	125	134.1	38.1	63	3.5	x	B	3.9	-	
16160-50.8R-06	16	160	169.1	50.8	63	3.5	x	B	5.0	-	

• Крепежные болты с каналом под СОЖ доступны по запросу (Пример заказа: SH M10x1.5x30-C)

Запчасти

Обозначение	Винт	Ключ			
14D-F45XN-06	TS 40B100I	T-T15			

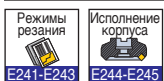

14D-F45XN-09

Торцевая фреза

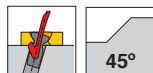
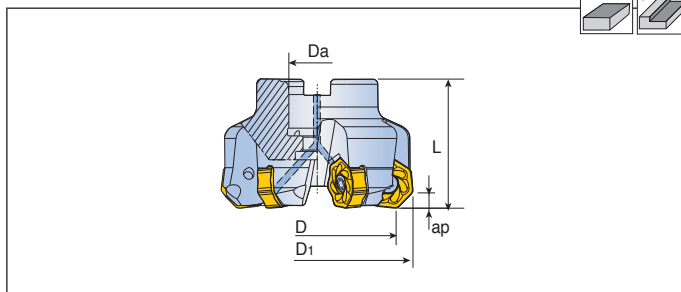
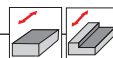

Обозначение		Размеры (мм)					Каналы СОЖ	Исполнение корпуса	Kg	Крепежный болт	Пластина
		D	D1	Da	L	ap					
14D-F45XN 563-22R-09	5	63	74.9	22	50	5	●	A	0.9	SH M10x1.5x25	XNM(H)U 0906... E238
663-22R-09	6	63	74.9	22	50	5	●	A	0.9	SH M10x1.5x25	
680-27R-09	6	80	91.9	27	50	5	●	A	1.4	SH M12x1.75x35	
780-27R-09	7	80	91.9	27	50	5	●	A	1.5	SH M12x1.75x35	
7100-32R-09	7	100	112	32	55	5	●	A	2.4	SH M16x2x35	
9100-32R-09	9	100	112	32	55	5	●	A	2.5	SH M16x2x35	
8125-40R-09	8	125	137	40	63	5	●	A	3.5	SH M20x2.5x40	
10125-40R-09	10	125	137	40	63	5	●	A	3.6	SH M20x2.5x40	
12125-40R-09	12	125	137	40	63	5	●	A	3.4	SH M20x2.5x40	
10160-40R-09	10	160	172	40	63	5	x	C	4.8	-	
12160-40R-09	12	160	172	40	63	5	x	C	4.8	-	
14160-40R-09	14	160	172	40	63	5	x	C	4.8	-	
12200-60R-09	12	200	212	60	63	5	x	C	6.8	-	
16200-60R-09	16	200	212	60	63	5	x	C	6.9	-	
16250-60R-09	16	250	262	60	63	5	x	C	11.5	-	
20250-60R-09	20	250	262	60	63	5	x	C	11.5	-	
14D-F45XN 680-25.4R-09	6	80	91.9	25.4	50	5	●	A	1.4	SH M12x1.75x35	
7100-31.75R-09	7	100	112	31.75	55	5	●	A	2.4	SH M16x2x35	
8125-38.1R-09	8	125	137	38.1	63	5	x	B	3.5	-	
10160-50.8R-09	10	160	172	50.8	63	5	x	B	4.8	-	
12200-47.625R-09	12	200	212	47.625	63	5	x	C	6.8	-	

• Крепежные болты с каналом под СОЖ доступны по запросу (Пример заказа: SH M10x1.5x30-C)

Запчасти

Обозначение	Винт	Ключ			
	14D-F45XN-09	TS 50C130I/HG	T-T20		



14D-F45XNW-09

Торцевая фреза

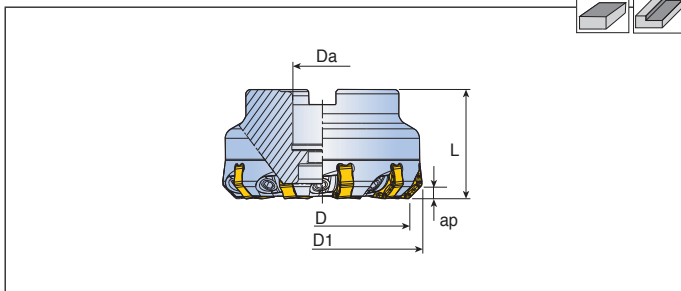

Обозначение		Размеры (мм)					Исполнение корпуса	кг	Крепежный болт	Пластина
		D	D1	Da	L	ap				
14D-F45XNW 1080-27R-09	10	80	91.9	27	50	5	A	1.8	SH M12x1.75x35	XNHU 0906... E238
14100-32R-09	14	100	112	32	55	5	A	2.9	SH M16x2x35	
18125-40R-09	18	125	137	40	63	5	B	3.8	-	
18160-40R-09	18	160	172	40	63	5	C	5.6	-	
22160-40R-09	22	160	172	40	63	5	C	5.6	-	
28200-60R-09	28	200	212	60	63	5	C	7.9	-	
36250-60R-09	36	250	262	60	63	5	C	12.7	-	
44315-60R-09	44	315	327	60	63	5	D	19.9	-	

Запчасти

Обозначение	Клин 	Винт клина 	Ключ 		
14D-F45XNW-09	WFZ 8H	WS 8	T-W4		

 Режимы резания E241-E243	 Исполнение корпуса E244-E245
---------------------------------	-------------------------------------

7S-F45-06

Торцевая фреза

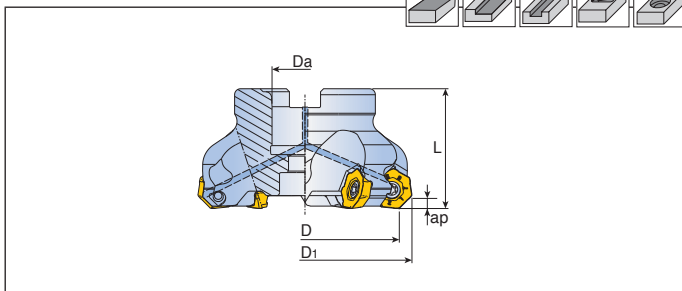
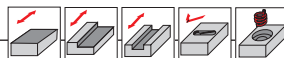

Обозначение		Размеры (мм)						Каналы СОЖ	Исполнение корпуса	Кг	Крепежный болт	Пластина
		D	D1	Da	L	ap						
7S-F45 332-16R-06	3	32	40.4	16	40	3.2	●	E	0.2	КТВ 32В	7EMT 0604...	
440-16R-06	4	40	48.5	16	40	3.2	●	A	0.3	SH M8X1.25X30	E198	
550-22R-06	5	50	58.5	22	40	3.2	●	A	0.4	LH M10X1.5X25		
663-22R-06	6	63	71.5	22	40	3.2	●	A	0.5	LH M10X1.5X25		
780-27R-06	7	80	88.5	27	50	3.2	●	A	1.3	LH M12X1.75X30		
8100-32R-06	8	100	108.5	32	50	3.2	●	A	1.9	LH M16X2X35		
9125-40R-06	9	125	133.5	40	63	3.2	●	A	3.3	SH M20X2.5X40		
7S-F45 780-25.4R-06	7	80	88.5	25.4	50	3.2	●	A	1.3	LH M12X1.75X30		
8100-31.75R-06	8	100	108.5	31.75	50	3.2	●	A	1.8	LH M16X2X35		
9125-38.1R-06	9	125	133.5	38.1	63	3.2	x	B	2.8	-		

• Крепежные болты с каналом под СОЖ доступны по запросу (Пример заказа: SH M10x1.5x30-C)

Запчасти

Обозначение	Винт	Ключ			
7S-F45-06	TS40093I/HG	T-T15			

Режимы резания

E241-E243

Исполнение корпуса

E244-E245

TFM45SN-13

Торцевая фреза

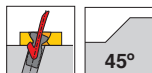
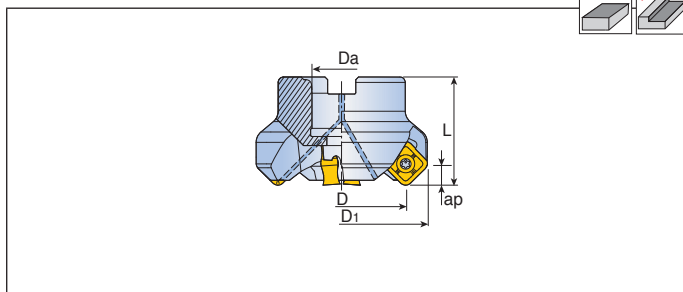

Обозначение		Размеры (мм)					Каналы СОЖ	Исполнение корпуса	Kg	Крепежный болт	Пластина
		D	D ₁	Da	L	ap					
TFM45SN 440-16R-13	4	40	54.7	22	40	7	●	A	0.3	LH M10x1.5x25	SNM(G)X 1306 AN... SNMX 1306 XTN E225
450-22R-13	4	50	64.7	22	40	7	●	A	0.5	LH M10x1.5x25	
650-22R-13	6	50	64.7	22	40	7	●	A	0.5	LH M10x1.5x25	
663-22R-13	6	63	77.7	22	40	7	●	A	0.7	LH M10x1.5x25	
863-22R-13	8	63	77.7	22	40	7	●	A	0.7	LH M10x1.5x25	
480-27R-13B	4	80	94.8	27	50	7	●	A	1.4	LH M12x1.75x30	
780-27R-13	7	80	94.8	27	50	7	●	A	1.5	LH M12x1.75x30	
1080-27R-13	10	80	94.8	27	50	7	●	A	1.5	LH M12x1.75x30	
5100-32R-13B	5	100	114.8	32	50	7	●	A	2.1	LH M16x2x35	
8100-32R-13	8	100	114.8	32	50	7	●	A	2.2	LH M16x2x35	
12100-32R-13	12	100	114.8	32	50	7	●	A	2.2	LH M16x2x35	
6125-40R-13B	6	125	139.8	40	63	7	●	A	3.8	SH M20x2.5x40	
10125-40R-13	10	125	139.8	40	63	7	●	A	3.8	SH M20x2.5x40	
16125-40R-13	16	125	139.6	40	63	7	●	A	3.8	SH M20x2.5x40	
8160-40R-13B	8	160	174.8	40	63	7	x	C	4.9	-	
12160-40R-13	12	160	174.8	40	63	7	x	C	4.9	-	
20160-40R-13	20	160	174.5	40	63	7	x	C	5.0	-	
10200-60R-13B	10	200	214.8	60	63	7	x	C	6.5	-	
18200-60R-13	18	200	214.8	60	63	7	x	C	6.6	-	
26200-60R-13	26	200	214.3	60	63	7	x	C	7.0	-	
20250-60R-13	20	250	264.8	60	63	7	x	C	12.9	-	

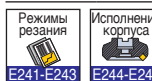

TFM45SN-13

Торцевая фреза (дюйм)



45°

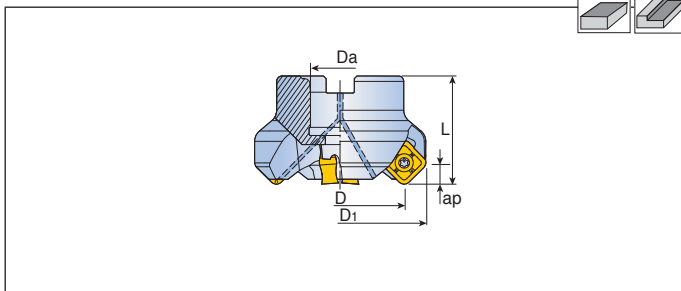

Обозначение		Размеры (мм)					Каналы СОЖ	Исполнение корпуса	Kg	Крепежный болт	Пластина
		D	D1	Da	L	ap					
TFM45SN 480-25.4R-13B	4	80	94.8	25.4	50	7	●	A	1.4	LH M12x1.75x30	SNM(G)X 1306 AN... SNMX 1306 XTN E225
5100-31.75R-13B	5	100	114.8	31.75	50	7	×	B	2.1	-	
6125-38.1R-13B	6	125	139.8	38.1	63	7	×	B	3.8	-	
10125-38.1R-13	10	125	139.8	38.1	63	7	×	B	3.4	-	
8160-50.8R-13B	8	160	174.8	50.8	63	7	×	B	4.9	-	
12160-50.8R-13	12	160	174.8	50.8	63	7	×	B	5.0	-	
10200-47.625R-13B	10	200	214.8	47.625	63	7	×	C	6.5	-	
12250-47.625R-13B	12	250	264.8	47.625	63	7	×	C	12.9	-	

• Крепежные болты с каналом под СОЖ доступны по запросу (Пример заказа: SH M10x1.5x30-C)

Запчасти

Обозначение	Винт	Ключ			
	TFM45SN-13	TS 40B1001	T-T15		

Режимы резания E241-E243

Исполнение корпуса E244-E245

TFM45SN-13-QC



Быстросменный корпус торцевой фрезы

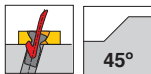
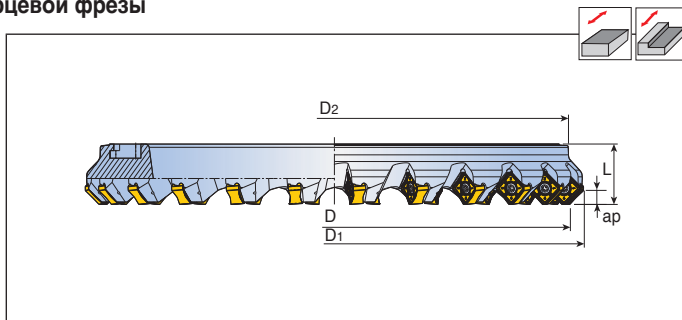

Обозначение		Размеры (мм)						Адаптер	Пластина
		D	D1	D2	L	ap			
TFM45SN 12250-13-QC	12	250	264.8	248	32	7	3.5	TQCA D250	SNM(G)X 1306 AN... SNMX 1306 XTN E225
24250-13-QC	24	250	264.7	248	32	7	3.7	TQCA D250	
14315-13-QC	14	315	329.8	313	38	7	8.1	TQCA D315	
30315-13-QC	30	315	329.7	313	38	7	8.2	TQCA D315	
16355-13-QC	16	355	369.8	353	38	7	9.3	TQCA D355	
34355-13-QC	34	355	369.7	353	38	7	9.4	TQCA D355	
18400-13-QC	18	400	414.8	398	38	7	10.6	TQCA D400	
38400-13-QC	38	400	414.7	398	38	7	10.7	TQCA D400	

• Рекомендуется для очень хороших условий резания чугуна и стали

Запчасти

Обозначение	Винт	Ключ			
	TFM45SN-13-QC	 TS 40B100I	 T-T15		



Торцевая фреза

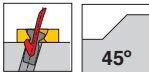
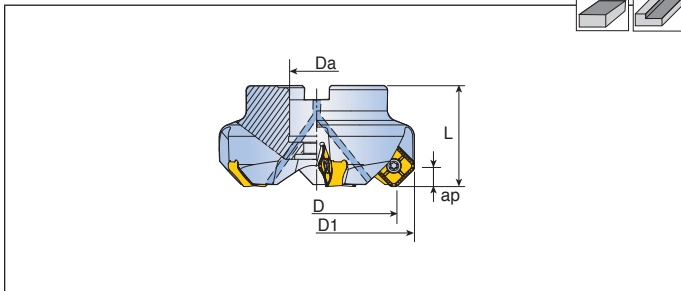
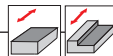

Обозначение		Размеры (мм)						Каналы СОЖ	Исполнение корпуса	Кг	Крепежный болт	Пластина
		D	D1	Da	L	ap						
TFM45SNS 463-22R-16	4	63	81.1	22	50	8.8	●	A	1.0	LH M10x1.5x25	SNMX 1607...	
580-27R-16	5	80	98.2	27	50	8.8	●	A	1.5	LH M12x1.75x30	SNHX 1606...	
7100-32R-16	7	100	118.2	32	50	8.8	●	A	2.3	LH M16x2.0x35	E227	
8125-40R-16	8	125	143.2	40	63	8.8	●	A	4.0	SH M20x2.5x40		
10125-40R-16	10	125	143.2	40	63	8.8	●	A	4.0	SH M20x2.5x40		
10160-40R-16	10	160	178.2	40	63	8.8	x	C	5.4	-		
12160-40R-16	12	160	178.2	40	63	8.8	x	C	5.4	-		
12200-60R-16	12	200	218.2	60	63	8.8	x	C	7.5	-		
14250-60R-16	14	250	268.2	60	63	8.8	x	C	13	-		
TFM45SNS 580-25.4R-16	5	80	98.2	25.4	50	8.8	●	A	1.5	LH M12x1.75x30		
7100-31.75R-16	7	100	118.2	31.75	50	8.8	x	B	2.3	-		
8125-38.1R-16	8	125	143.2	38.1	63	8.8	x	B	4.0	-		
10160-50.8R-16	10	160	178.2	50.8	63	8.8	x	B	5.4	-		
12200-47.625R-16	12	200	218.2	47.625	63	8.8	x	C	7.5	-		

• Крепежные болты с каналом под СОЖ доступны по запросу (Пример заказа: SH M10x1.5x30-C)

Запчасти

Обозначение	Винт	Ключ			
TFM45SNS-16	TS 45120I	T-T20			

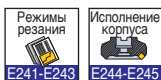

TFM45SNS-16B-CA

Торцевая фреза

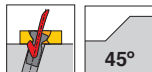
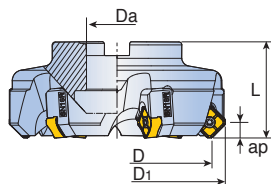
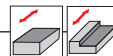

45°

Обозначение		Размеры (мм)					Исполнение корпуса	Kg	Пластина
		D	D ₁	D _a	L	ap			
TFM45SNS 6125-40R-16B-CA	6	125	143.2	40	63	8.8	B	4.0	SNMX 1607... SNHX 1606... E27
8160-40R-16B-CA	8	160	178.2	40	63	8.8	C	5.9	
10200-60R-16B-CA	10	200	218.2	60	63	8.8	C	8.1	
14250-60R-16-CA	14	250	268.2	60	63	8.8	C	13.3	
14315-60R-16B-CA	14	315	333.2	60	80	8.8	D	24.0	

Запчасти

Обозначение	Винт 	Картридж 	Винт картриджа 	Ключ 	
TFM45SNS-16B-CA	TS 45120I	TCT23-SN16R	TS 60170I	T-T20	



TFM45SNW-16

Торцевая фреза

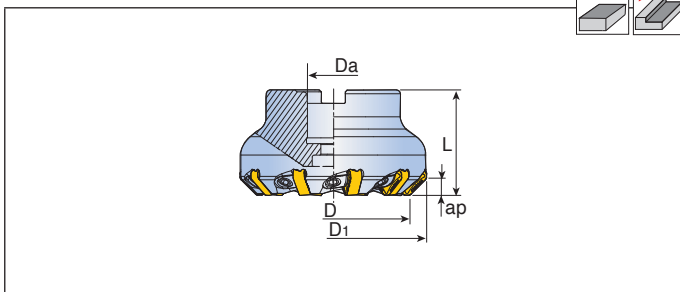

Обозначение		Размеры (мм)					Исполнение корпуса	Kg	Крепежный болт	Пластина
		D	D1	Da	L	ap				
TFM45SNW 1080-27R-16	10	80	98.2	27	55	8.8	A	1.9	LH M12x1.75x35	SNHX 1606... E227
14100-32R-16	14	100	118.2	32	63	8.8	A	3.2	SH M16x2.0x35	
18125-40R-16	18	125	143.2	40	63	8.8	B	3.9	-	
22160-40R-16	22	160	178.2	40	63	8.8	C	5.7	-	
26200-60R-16	26	200	218.2	60	63	8.8	C	7.8	-	
32250-60R-16	32	250	268.2	60	63	8.8	C	13.5	-	

Запчасти

Обозначение	Клин	Винт клина	Ключ		
TFM45SNW	WFZ 8H-SN	WS 8	T-W4		

Режимы резания

E241-E243

Исполнение корпуса

E244-E245

TQ45SNW-16

Быстросменный корпус торцевой фрезы

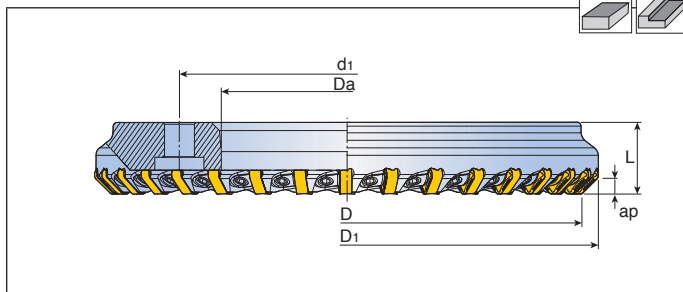

Обозначение		Размеры (мм)							Адаптер	Пластина
		D	D1	Da	d1	L	ap			
TQ45SNW 26200R-16	26	200	218.2	63.5	114.3	38	8.8	6.3	QA 08 K/M	SNHX 1606...
34250R-16	34	250	268.2	133.35	177.8	38	8.8	7.9	QA 10 K/M	
44315R-16	44	315	333.2	146.05	215.9	38	8.8	13.2	QA 12 K/M	
50355R-16	50	355	373.2	215.90	260.4	38	8.8	13.0	QA 14 K/M	

• Рекомендуется для очень хороших условий резания чугуна и стали

Запчасти

Обозначение	Клин	Винт клина	Ключ		
TQ45SNW	WFZ 8H-SN	WS 8	T-W4		

Режимы резания
E241-E243

Исполнение корпуса
E244-E245

Техническая информация
E246-E247

TFM45AN-16



Торцевая фреза

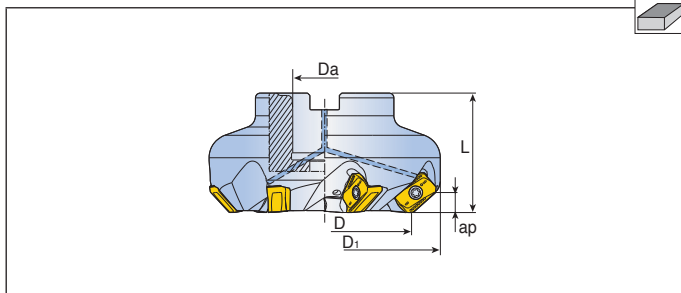

Обозначение		Размеры (мм)					Каналы СОЖ	Исполнение корпуса	Kg	Крепежный болт	Пластина
		D	D ₁	Da	L	ap					
TFM45AN 450-22R-16	4	50	67.8	22	40	8.4	●	A	0.6	LH M10x1.5x25	ANHX 1607 ANR-M E198
663-22R-16	6	63	80.6	22	40	8.4	●	A	0.9	LH M10x1.5x25	
780-27R-16	7	80	97.5	27	50	8.4	●	A	1.6	SH M12x1.75x35	
8100-32R-16	8	100	117.5	32	50	8.4	●	A	2.5	LH M16x2x35	
9125-40R-16	9	125	142.6	40	63	8.4	●	A	4.3	SH M20x2.5x40	
10160-40R-16	10	160	177.7	40	63	8.4	x	B	5.8	-	

- Корпус не предназначен для 90-ых пластин
- Крепежные болты с каналом под СОЖ доступны по запросу (Пример заказа: SH M10x1.5x30-C)

Запчасти

Обозначение	Винт	Ключ			
TFM45AN	TS 40120I	T-T15			

 Режимы резания	 Исполнение корпуса
E241-E243	E244-E245

TFM45HNS-10

Торцевая фреза

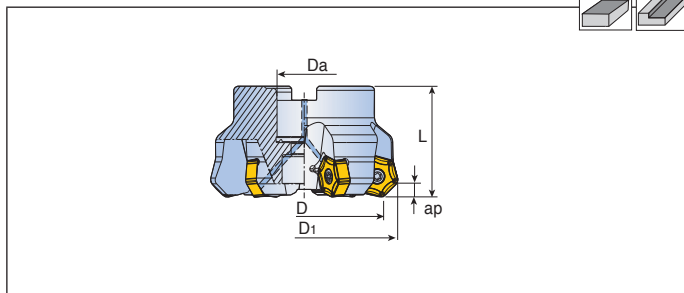
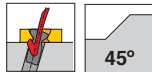
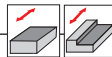

Обозначение		Размеры (мм)					Каналы СОЖ	Исполнение корпуса	кг	Крепежный болт	Пластина
		D	D1	Da	L	ap					
TFM45HNS 563-22R-10	5	63	77	22	50	6.1	●	A	0.8	SH M10x1.5x25	HNLX 1006... E210
663-22R-10F	6	63	77	22	50	6.1	●	A	0.9	SH M10x1.5x25	
680-27R-10	6	80	94	27	55	6.1	●	A	1.6	SH M12x1.75x35	
780-27R-10F	7	80	94	27	55	6.1	●	A	1.6	SH M12x1.75x35	
7100-32R-10	7	100	114	32	63	6.1	●	A	2.7	SH M16x2x35	
9100-32R-10F	9	100	114	32	63	6.1	●	A	2.8	SH M16x2x35	
8125-40R-10	8	125	139	40	63	6.1	×	B	3.4	-	
10125-40R-10	10	125	139	40	63	6.1	×	B	3.4	-	
12125-40R-10F	12	125	139	40	63	6.1	×	B	3.4	-	
10160-40R-10	10	160	174	40	63	6.1	×	C	4.8	-	
12160-40R-10	12	160	174	40	63	6.1	×	C	4.8	-	
14160-40R-10F	14	160	174	40	63	6.1	×	C	4.9	-	
12200-60R-10	12	200	214	60	63	6.1	×	C	6.9	-	
16200-60R-10F	16	200	214	60	63	6.1	×	C	7.0	-	
16250-60R-10	16	250	264	60	63	6.1	×	C	11.8	-	
20250-60R-10F	20	250	264	60	63	6.1	×	C	12.0	-	

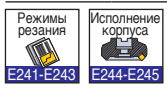

TFM45HNS-10

Торцевая фреза (дюйм)

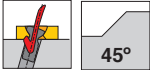
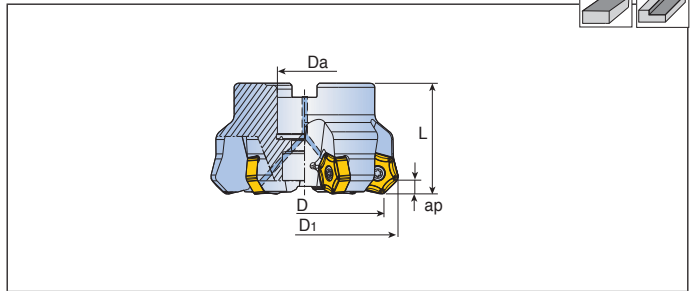
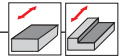

45°

Обозначение		Размеры (мм)						Каналы СОЖ	Исполнение корпуса	Kg	Крепежный болт	Пластина
		D	D1	Da	L	ap						
TFM45HNS 680-25.4R-10	6	80	94	25.4	55	6.1	●	A	1.6	SH M12x1.75x35	HNHX 1006... E210	
7100-31.75R-10	7	100	114	31.75	63	6.1	x	B	2.7	-		
9100-31.75R-10F	9	100	114	31.75	63	6.1	x	B	2.8	-		
8125-38.1R-10	8	125	139	38.1	63	6.1	x	B	3.4	-		
10125-38.1R-10	10	125	139	38.1	63	6.1	x	B	3.4	-		
10160-50.8R-10	10	160	174	50.8	63	6.1	x	B	4.8	-		
12160-50.8R-10	12	160	174	50.8	63	6.1	x	B	4.8	-		
12200-47.625R-10	12	200	214	47.625	63	6.1	x	C	6.9	-		
16250-47.625R-10	16	250	264	47.625	63	6.1	x	C	11.8	-		

• Крепежные болты с каналом под СОЖ доступны по запросу (Пример заказа: SH M10x1.5x30-C)

Запчасти

Обозначение	Винт	Ключ			
	TFM45HNS	TS 50C130/HG	T-T20		

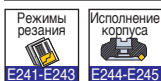

TFM45HN-10

Торцевая фреза

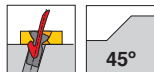
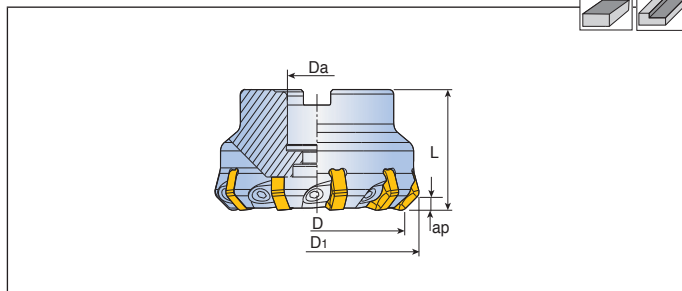
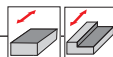

Обозначение		Размеры (мм)					Исполнение корпуса	Кг	Крепежный болт	Пластина
		D	D1	Da	L	ap				
TFM45HN 1080-27R-10	10	80	94	27	55	6.1	A	1.9	SH M12x1.75x35	HNHX 1006...
14100-32R-10	14	100	114	32	63	6.1	A	3.3	SH M16x2x35	E210
18125-40R-10	18	125	139	40	63	6.1	B	3.9	-	
22160-40R-10	22	160	174	40	63	6.1	C	5.6	-	
28200-60R-10	28	200	214	60	63	6.1	C	7.9	-	
36250-60R-10	36	250	264	60	63	6.1	C	13.1	-	
44315-60R-10	44	315	329	60	63	6.1	D	21.2	-	

Запчасти

Обозначение	Клин	Винт клина	Ключ		
TFM45HN	WFZ 8H	WS 8	T-W4		



Торцевая фреза

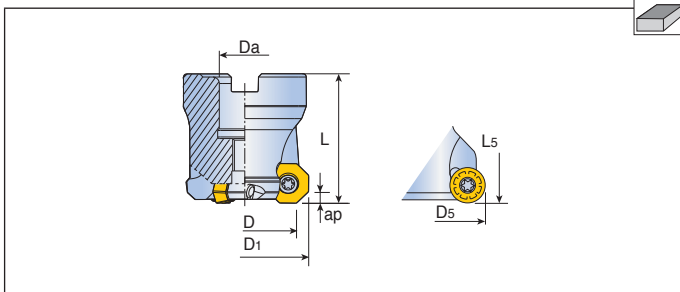

Обозначение	⊙	Размеры (мм)							Исполнение корпуса	Крепежный болт	Пластина		
		D	D1	D5	Da	L	L5	ap					
TFM430FS	332-16R-05	3	32	39.6	40.8	16	40	40.6	3.5	E	0.3	КТВ32В	OFCW 05Т3...
	440-16R-05	4	40	47.5	48.7	16	40	40.6	3.5	A	0.4	SH M8x1.25x30	OFCT 05Т3...
	550-22R/L-05	5	50	57.9	59.0	22	40	40.6	3.5	A	0.6	SH M10x1.5x30	OFMT 05Т3...
	663-22R-05	6	63	71.0	72.0	22	40	40.6	3.5	A	1.0	SH M10x1.5x30	RFMT 1404...
	780-27R/L-05	7	80	88.0	89.0	27	50	50.6	3.5	A	1.3	SH M12x1.75x35	E215
	8100-32R-05	8	100	108.0	109.0	32	50	50.6	3.5	A	2.6	LH M16x2x35	
TFM430FS	9125-40R-05	9	125	133.0	134.0	40	63	63.6	3.5	B	3.0	-	
	780-25.4R-05	7	80	88.0	89.0	25.4	50	50.6	3.5	A	1.3	SH M12x1.75x35	
	9125-38.1R-05	9	125	133.0	134.0	38.1	63	63.6	3.5	B	3.0	-	

Запчасти

Обозначение	Винт	Ключ			
TFM430FS	TS 40093I	T-T15			

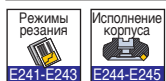

TFM43ZOFW-07

Торцевая фреза

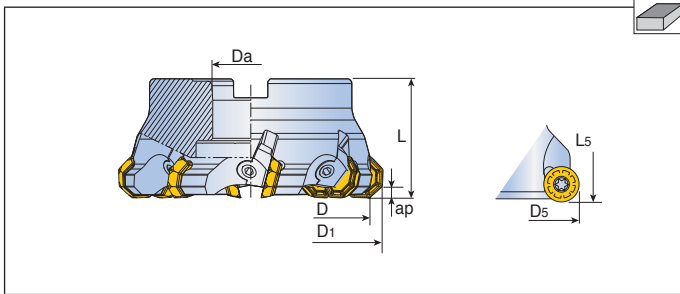

Обозначение		Размеры (мм)								Исполнение корпуса	Кг	Крепежный болт	Пластина
		D	D1	D5	Da	L	L5	ap					
TFM43ZOFW 463-22R-07	4	63	75.1	76.09	22	40	40.7	5	A	0.5	LH M10x1.5x25	OFCN 0704...	
580-27R-07	5	80	92.0	93.08	27	50	50.7	5	A	1.2	SH M12x1.75x35	OFCR 0704...	
6100-32R-07	6	100	112.0	113.07	32	50	50.7	5	B	1.8	-	OFMR 0704 ...	
8100-32R-07	8	100	112.0	113.07	32	50	50.7	5	B	1.8	-	RFMR 1904...	
8125-40R-07	8	125	137.0	138.06	40	63	63.7	5	B	3.0	-	E214	
10125-40R-07	10	125	137.0	138.06	40	63	63.7	5	B	3.0	-		
10160-40R-07	10	160	172.0	173.06	40	63	63.7	5	C	4.7	-		
12160-40R-07	12	160	172.0	173.06	40	63	63.7	5	C	4.7	-		
12200-60R-07	12	200	212.0	213.05	60	63	63.7	5	C	7.0	-		
14200-60R-07	14	200	212.0	213.05	60	63	63.7	5	C	7.0	-		
TFM43ZOFW 6100-31.75R-07	6	100	112.0	113.07	31.75	50	50.7	5	B	1.8	-		
8125-38.1R-07	8	125	137.0	138.06	38.1	63	63.7	5	B	3.0	-		
10160-50.8R-07	10	160	172.0	173.06	50.8	63	63.7	5	B	4.7	-		

Запчасти

Обозначение	Винт клина	Клин	Ключ		
TFM43ZOFW	WS8, *WS8S, WS8M	WFO-8Z	T-TW4		

Режимы резания E241-E243

Исполнение корпуса E244-E245

• *WS8S: Только для TFM43ZOFW-463...

LM45SD-12/15

LIONMILL

Торцевая фреза (дюйм)

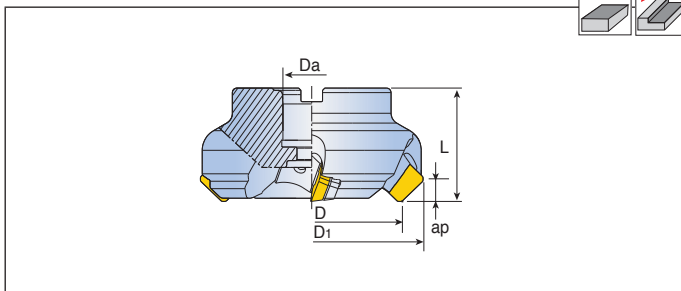

Обозначение		Размеры (мм)					Исполнение корпуса		Крепежный болт	Пластина
		D	D1	Da	L	ap				
LM45SD 480-25.4R-12	4	80	93.8	25.4	50	6.5	A	1.6	LH M12x1.75x30	SDKN 1203...
5100-31.75R-12	5	100	113.8	31.75	60	6.5	A	2.8	LH M16x2x35	E221
6125-38.1R/L-12	6	125	138.8	38.1	63	6.5	B	3.5	-	-
8160-50.8R-12	8	160	173.9	50.8	63	6.5	B	5.5	-	-
10200-47.625R/L-12	10	200	213.9	47.625	63	6.5	C	7.6	-	-
12250-47.625R/L-12	12	250	263.9	47.625	63	6.5	C	12.6	-	-
LM45SD 480-25.4R-15	4	80	93.8	25.4	50	8.7	A	1.6	LH M12x1.75x30	SDKN 1504...
5100-31.75R-15	5	100	118.6	31.75	60	8.7	A	2.8	LH M16x2x35	E221
6125-38.1R/L-15	6	125	143.6	38.1	63	8.7	B	3.5	-	-
8160-50.8R/L-15	8	160	178.6	50.8	63	8.7	B	5.5	-	-
10200-47.625R/L-15	10	200	218.6	47.625	63	8.7	C	7.6	-	-
12250-47.625R/L-15	12	250	268.6	47.625	63	8.7	C	12.6	-	-
14315-47.625R/L-15	14	315	333.54	47.625	63	6.7	C	18.7	-	-

• Метрическое исполнение корпусов доступно по запросу

Запчасти

Обозначение	Твердосплавная опорная пластина	Клин	Винт опорной пластины	Винт клина	Ключ	Ключ винта опорной пластины
LM45SD-12	TSSDSE 12N	WPA 8	TS 40B100I	TS 80200W TS 80160W ⁽¹⁾	T-W4	T-T15
LM45SD-15	TSSDSE 15N	WPA 8	TS 40B100I	TS 80200W TS 80160W ⁽¹⁾	T-W4	T-T15



- ⁽¹⁾ TS 80160W предназначен для фрезы D80
- Ключ винта опорной пластины T-T15⁽²⁾ заказывается отдельно

LM45SE-12/15

Торцевая фреза (дюйм)

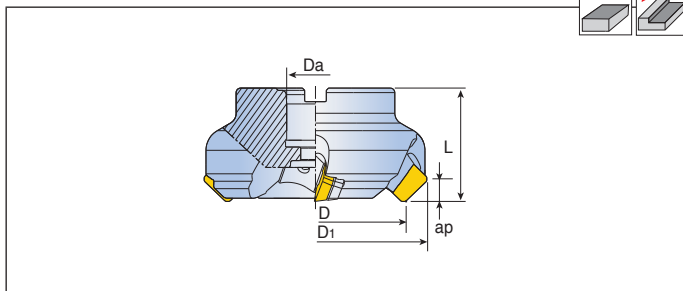

Обозначение		Размеры (мм)					Исполнение корпуса		Крепежный болт	Пластина
		D	D ₁	D _a	L	ap				
LM45SE 480-25.4R-12	4	80	93.7	25.4	55	6.5	A	1.8	LH M12x1.75x30	SEKN 1203...
5100-31.75R-12	5	100	113.6	31.75	60	6.5	A	2.8	LH M16x2x35	E222
6125-38.1R-12	6	125	138.6	38.1	63	6.5	B	3.4	-	
8160-50.8R/L-12	8	160	173.6	50.8	63	6.5	B	5	-	
10200-47.625R/L-12	10	200	213.6	47.625	63	6.5	C	7.5	-	
12250-47.625R-12	12	250	263.6	47.625	63	6.5	C	12.2	-	
LM45SE 480-25.4R-15	4	80	97.8	25.4	55	8.7	A	1.8	LH M12x1.75x30	SEKN 1504...
5100-31.75R-15	5	100	118	31.75	60	8.7	A	2.8	LH M16x2x35	E222
6125-38.1R-15	6	125	143	38.1	63	8.7	B	3.5	-	
8160-50.8R/L-15	8	160	178	50.8	63	8.7	B	5.7	-	
10200-47.625R/L-15	10	200	218	47.625	63	8.7	C	7.8	-	
12250-47.625R-15	12	250	268	47.625	63	8.7	C	12.8	-	

• Метрическое исполнение корпусов доступно по запросу

Запчасти

Обозначение	Твердосплавная опорная пластина	Клин	Винт опорной пластины	Винт клина	Ключ	Ключ винта опорной пластины
LM45SE-12	TSSDSE 12N	WPA 8	TS 40B100I	TS 80200W	T-W4	T-T15
LM45SE-15	TSSDSE 15N	WPA 8	TS 40B100I	TS 80160W ⁽¹⁾	T-W4	T-T15

Режимы резания

E241-E243

Исполнение корпуса

E244-E245

- ⁽¹⁾ TS 80160W предназначен для фрезы D80
- Ключ винта опорной пластины T-T15⁽²⁾ заказывается отдельно

TFM15HNS-10

Торцевая фреза

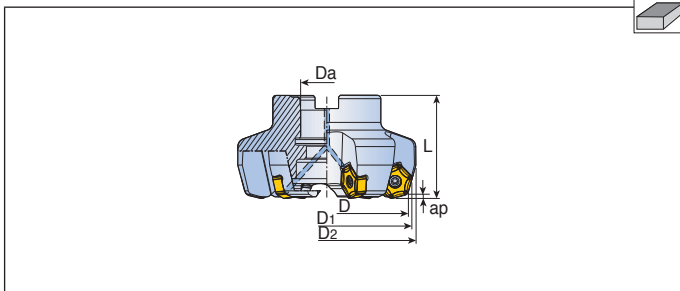

15°

Обозначение		Размеры (мм)						Каналы СОЖ	Исполнение корпуса	Kg	Крепежный болт	Пластина
		D	D ₁	D ₂	Da	L	ap					
TFM15HNS 580-27R-10	5	80	85	89	27	55	2	•	A	1.3	SH M12x1.75x35	HNHX 1006 ANTN-M
6100-32R-10	6	100	105	109	32	63	2	x	B	1.9	-	E210
8125-40R-10	8	125	130	134	40	63	2	x	B	2.9	-	

• Крепежные болты с каналом под СОЖ доступны по запросу (Пример заказа: SH M10x1.5x30-C)

Запчасти

Обозначение	Винт	Ключ			
TFM15HNS	TS 50C130I/HG	T-T20			

 Режимы резания E241-E243	 Исполнение корпуса E244-E245
---------------------------------	-------------------------------------

Торцевая фреза

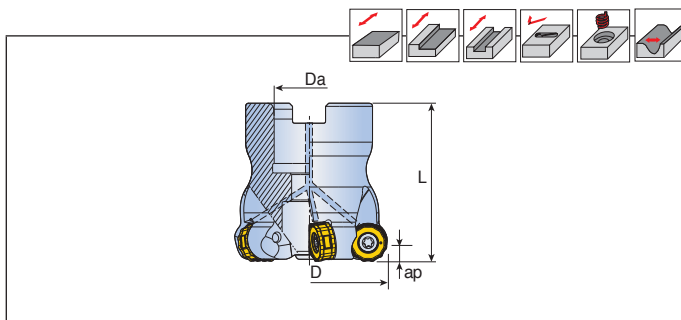

Обозначение		Размеры (мм)				Каналы СОЖ	Исполнение корпуса	Kg	Крепежный болт	Пластина
		D	Da	L	ap					
TFMRNS 432-16R-10	4	32	16	40	5	●	E	0.1	КТВ 32В	RNMU 1004...
433-16R-10	4	33	16	40	5	●	E	0.1	КТВ 32В	E216
540-16R-10	5	40	16	40	5	●	A	0.2	SH M8x1.25x30	
650-22R-10	6	50	22	50	5	●	A	0.4	SH M10x1.5x30	
652-22R-10	6	52	22	50	5	●	A	0.4	SH M10x1.5x30	
TFMRNS 440-16R-12	4	40	16	40	6	●	A	0.2	SH M8x1.25x30	RNMU 1205...
450-22R-12	4	50	22	50	6	●	A	0.3	SH M10x1.5x30	E216
550-22R-12	5	50	22	50	6	●	A	0.3	SH M10x1.5x30	
552-22R-12	5	52	22	50	6	●	A	0.4	SH M10x1.5x30	
563-22R-12	5	63	22	50	6	●	A	0.6	SH M10x1.5x30	
663-22R-12	6	63	22	50	6	●	A	0.6	SH M10x1.5x30	
666-27R-12	6	66	27	50	6	●	A	0.6	SH M12x1.75x35	
680-27R-12	6	80	27	50	6	●	A	1.1	SH M12x1.75x35	
780-27R-12	7	80	27	50	6	●	A	1.0	SH M12x1.75x35	
7100-32R-12	7	100	32	50	6	●	A	1.5	LH M16x2x35	
8100-32R-12	8	100	32	50	6	●	A	1.5	LH M16x2x35	

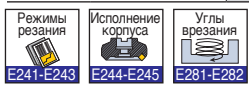

Торцевая фреза

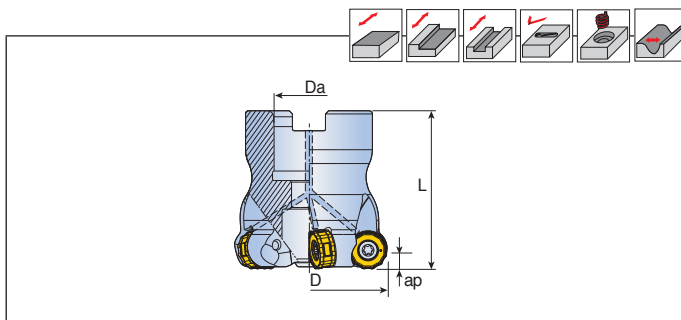

Обозначение		Размеры (мм)				Каналы СОЖ	Исполнение корпуса	Кг	Крепежный болт	Пластина
		D	Da	L	ap					
TFMRNS 340-16R-16	3	40	16	55	8	●	E	0.3	КТВ 32В	RNMU 1606...
350-16R-16	3	50	16	50	8	●	A	0.2	SH M8x1.25x30	
450-16R-16	4	50	16	50	8	●	A	0.2	SH M8x1.25x30	
452-22R-16	4	52	22	50	8	●	A	0.3	SH M10x1.5x30	
463-22R-16	4	63	22	50	8	●	A	0.5	SH M10x1.5x30	
566-27R-16	5	66	27	50	8	●	A	0.6	LH M12x1.75x30	
580-27R-16	5	80	27	50	8	●	A	0.9	LH M12x1.75x30	
680-27R-16	6	80	27	50	8	●	A	0.8	LH M12x1.75x30	
6100-32R-16	6	100	32	50	8	●	A	1.7	LH M16x2.0x35	
7125-40R-16	7	125	40	63	8	●	A	3.0	SH M20x2.5x40	
8125-40R-16	8	125	40	63	8	●	A	2.9	SH M20x2.5x40	
9160-40R-16	9	160	40	63	8	x	C	3.8	-	
10200-60R-16	10	200	60	63	8	x	C	5.6	-	

• Крепежные болты с каналом под СОЖ доступны по запросу (Пример заказа: SH M10x1.5x30-C)

Запчасти

Обозначение	Винт	Ключ			
TFMRNS-10	TS 35085I/HG	T-T15			
TFMRNS-12	TS 40G110I	T-T15			
TFMRNS-16	TS 50A121I/HG	T-T20			



Торцевая фреза

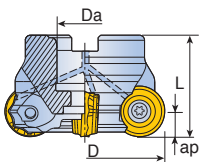
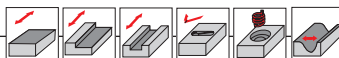

Обозначение		Размеры (мм)				Каналы СОЖ	Исполнение корпуса		Крепежный болт	Пластина	
		D	Da	L	ap						
TFMRX 650-22R-10	6	50	22	40	5	●	A	0.3	SH M10x1.5x30	RXM(H)X 1003... E217	
	652-22R-10	6	52	22	40	5	●	A	0.3		SH M10x1.5x30
TFMRX 450-22R-12	4	50	22	40	6	●	A	0.2	SH M10x1.5x25	RXM(H)X 12T3... E217	
	550-22R-12	5	50	22	40	6	●	A	0.2		SH M10x1.5x25
	552-22R-12	5	52	22	40	6	●	A	0.3		SH M10x1.5x30
	563-22R-12	5	63	22	40	6	●	A	0.4		SH M10x1.5x25
	663-22R-12	6	63	22	40	6	●	A	0.4		SH M10x1.5x25
	666-27R-12	6	66	27	50	6	●	A	0.6		SH M10x1.5x25
	680-27R-12	6	80	27	50	6	●	A	0.8		SH M12x1.75x35
	7100-32R-12	7	100	32	50	6	x	B	1.2		-
TFMRX 680-25.4R-12	6	80	25.4	50	6	●	A	1.1	SH M12x1.75x35		
	7100-31.75R-12	7	100	31.75	50	6	x	B	1.5	-	

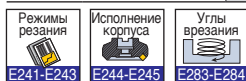

Торцевая фреза

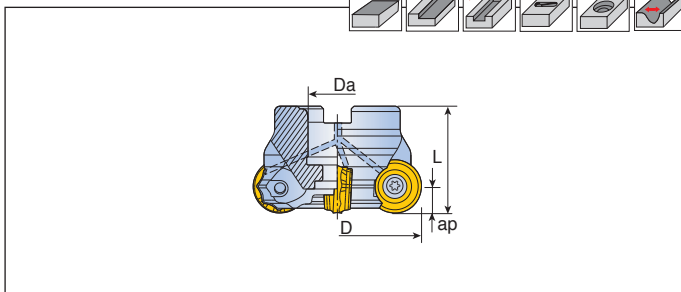
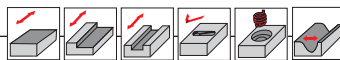

Обозначение		Размеры (мм)				Каналы СОЖ	Исполнение корпуса	Kg	Крепежный болт	Пластина
		D	Da	L	ap					
TFMRX 450-16R-16	4	50	16	40	8	●	A	0.2	SH M8x1.25x30	RXMX 1604...
452-16R-16	4	52	16	40	8	●	A	0.2	SH M8x1.25x30	
463-22R-16	4	63	22	40	8	●	A	0.4	SH M10x1.5x25	
566-27R-16	5	66	27	50	8	●	A	0.5	SH M12x1.75x35	
580-27R-16	5	80	27	50	8	●	A	0.8	SH M12x1.75x35	
6100-32R-16	6	100	32	50	8	x	B	1.1	-	
7125-40R-16	7	125	40	63	8	x	B	2.4	-	
8160-40R-16	8	160	40	63	8	x	C	3.6	-	
TFMRX 580-25.4R-16	5	80	25.4	50	8	●	A	1.0	SH M12x1.75x35	
6100-31.75R-16	6	100	31.75	50	8	x	B	1.4	-	
TFMRX 463-22R-20	4	63	22	40	10	●	A	0.3	LH M10x1.5x25	RXMX 2006...
580-27R-20	5	80	27	50	10	●	A	0.8	LH M12x1.75x30	
6100-32R-20	6	100	32	50	10	x	B	1.0	-	
7125-40R-20	7	125	40	63	10	x	B	2.5	-	
8160-40R-20	8	160	40	63	10	x	C	3.7	-	

• Крепежные болты с каналом под СОЖ доступны по запросу (Пример заказа: SH M10x1.5x30-C)

Запчасти

Обозначение	Винт	Ключ			
TFMRX-10	TS 35070I/HG	T-T15			
TFMRX-12	TS 35085I/HG	T-T15			
TFMRX-16	TS 45A100I/HG	T-T20			
TFMRX-20	TS 50115I	T-T20			



TFMRY-08/10

CHASEMOLD

Торцевая фреза

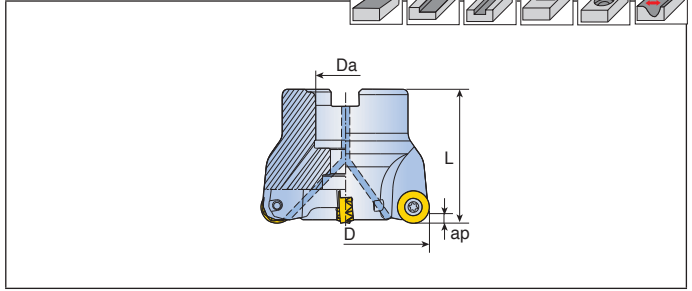
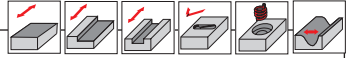

Обозначение	R	🌀	Размеры (мм)				Каналы СОЖ	Исполнение корпуса	Kg	Крепежный болт	Пластина
			D	Da	L	ap					
TFMRY 532-16R-08	4	5	32	16	40	4	●	A	0.12	SH M8x1.25x30	RYM(H)X 0803...
640-16R-08	4	6	40	16	40	4	●	A	0.22	SH M8x1.25x30	📄 E218-E219
TFMRY 432-16R-10	5	4	32	16	40	5	●	A	0.12	SH M8x1.25x30	RYM(H)X 1004...
540-16R-10	5	5	40	16	40	5	●	A	0.22	SH M8x1.25x30	📄 E218-E219
640-16R-10	5	6	40	16	40	5	●	A	0.23	SH M8x1.25x30	
650-22R-10	5	6	50	22	50	5	●	A	0.33	SH M10x1.5x30	
652-22R-10	5	6	52	22	50	5	●	A	0.36	SH M10x1.5x30	
763-22R-10	5	7	63	22	50	5	●	A	0.57	SH M10x1.5x30	
766-27R-10	5	7	66	27	50	5	●	A	0.68	SH M12x1.75x30	



Торцевая фреза

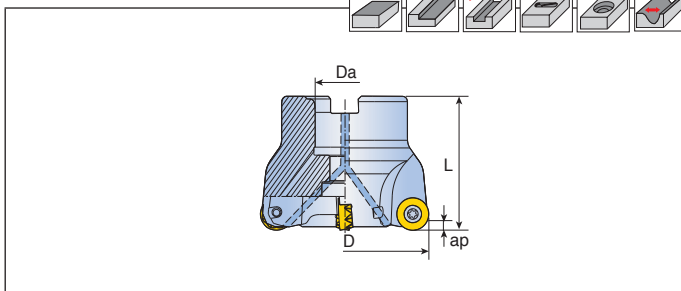
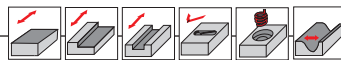

Обозначение	R		Размеры (мм)				Каналы СОЖ	Исполнение корпуса	Кg	Крепежный болт	Пластина
			D	Da	L	ap					
TFMRY 332-16R-12	6	3	32	16	40	6	●	E	0.12	КТВ 32В	RYM(H)X 1205... E218-E219
440-16R-12	6	4	40	16	40	6	●	A	0.15	SH M8x1.25x30	
442-16R-12	6	4	42	16	40	6	●	A	0.21	SH M8x1.25x30	
450-22R-12	6	4	50	22	50	6	●	A	0.33	SH M10x1.5x30	
550-22R-12	6	5	50	22	50	6	●	A	0.33	SH M10x1.5x30	
552-22R-12	6	5	52	22	50	6	●	A	0.34	SH M10x1.5x30	
463-22R-12	6	4	63	22	50	6	●	A	0.57	SH M10x1.5x30	
563-22R-12	6	5	63	22	50	6	●	A	0.58	SH M10x1.5x30	
663-22R-12	6	6	63	22	50	6	●	A	0.58	SH M10x1.5x30	
763-22R-12	6	7	63	22	50	6	●	A	0.71	SH M10x1.5x30	
666-27R-12	6	6	66	27	50	6	●	A	0.62	LH M12x1.75x30	
766-27R-12	6	7	66	27	50	6	●	A	0.62	LH M12x1.75x30	
680-27R-12	6	6	80	27	50	6	●	A	0.90	LH M12x1.75x30	
780-27R-12	6	7	80	27	50	6	●	A	0.92	LH M12x1.75x30	
880-27R-12	6	8	80	27	50	6	●	A	0.98	LH M12x1.75x30	
7100-32R-12	6	7	100	32	50	6	●	A	1.29	LH M16x2x35	
8100-32R-12	6	8	100	32	50	6	●	A	1.37	LH M16x2x35	
8125-40R-12	6	8	125	40	63	6	●	A	3.00	SH M20x2.5x40	
9125-40R-12	6	9	125	40	63	6	●	A	2.99	SH M20x2.5x40	

• Крепежные болты с каналом под СОЖ доступны по запросу (Пример заказа: SH M10x1.5x30-C)

Запчасти

Обозначение	Винт	Ключ			
TFMRY-08	TS 30A60I/HG	TD 9			
TFMRY-10	TS 35085/HG	T-T15			
TFMRY-12	TS 40093I	T-T15			



Торцевая фреза

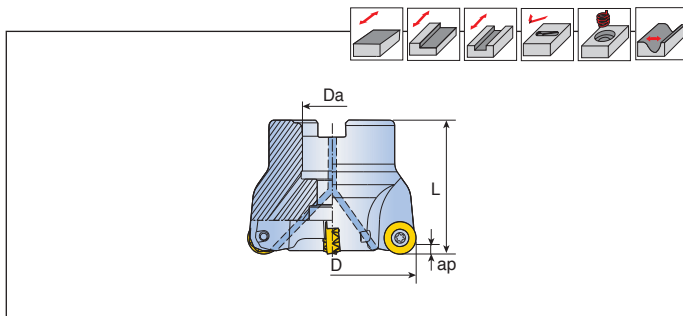

Обозначение	R		Размеры (мм)				Каналы СОЖ	Исполнение корпуса	Kg	Крепежный болт	Пластина
			D	Da	L	ap					
TFMRY 350-16R-16	8	3	50	16	50	8	●	A	0.3	SH M8x1.25x35	RYM(H)X 1606... E218-E219
450-16R-16	8	4	50	16	50	8	●	A	0.3	SH M8x1.25x35	
450-22R-16	8	4	50	22	50	8	●	A	0.3	SH M10x1.5x30	
452-22R-16	8	4	52	22	50	8	●	A	0.3	SH M10x1.5x30	
463-22R-16	8	4	63	22	50	8	●	A	0.5	SH M10x1.5x30	
463H-22R-16*	8	4	63	22	50	8	●	A	0.5	SH M10x1.5x30	
566-27R-16	8	5	66	27	50	8	●	A	0.6	LH M12x1.75x30	
580-27R-16	8	5	80	27	50	8	●	A	0.8	LH M12x1.75x30	
580H-27R-16*	8	5	80	27	50	8	●	A	0.8	LH M12x1.75x30	
680-27R-16	8	6	80	27	50	8	●	A	0.8	LH M12x1.75x30	
6100-32R-16	8	6	100	32	50	8	●	A	1.2	LH M16x2x35	
6100H-32R-16*	8	6	100	32	50	8	●	A	1.2	LH M16x2x35	
7125-40R-16	8	7	125	40	63	8	●	A	2.7	SH M20x2.5x40	
7125H-40R-16*	8	7	125	40	63	8	●	A	2.6	SH M20x2.5x40	
8125-40R-16	8	8	125	40	63	8	●	A	2.7	SH M20x2.5x40	
8160H-40R-16*	8	8	160	40	63	8	x	C	3.3	-	
TFMRY 580-25.4R-16	8	5	80	25.4	50	8	●	A	1.0	SH M12x1.75x35	

Режимы резания
 E241-E243

Исполнение корпуса
 E244-E245

Углы врезания
 E286

●*: Твердосплавная опорная пластина

Торцевая фреза

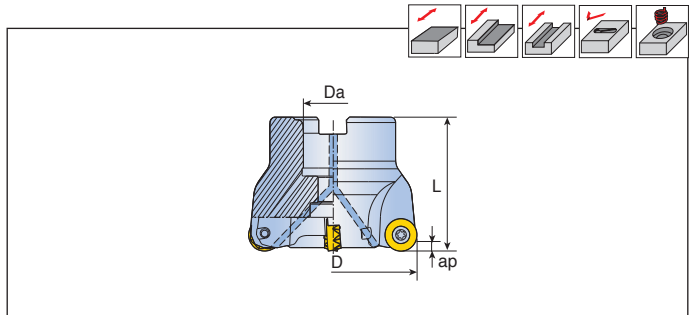

Обозначение	R		Размеры (мм)				Каналы СОЖ	Исполнение корпуса		Крепежный болт	Пластина
			D	Da	L	ap					
TFMRY 463-22R-20	10	4	63	22	50	10	●	A	0.5	SH M10x1.5x30	RYMX 2007... E218-E219
580-27R-20	10	5	80	27	50	10	●	A	0.8	LH M12x1.75x30	
5100H-32R-20*	10	5	100	32	50	10	●	A	1.1	LH M16x2x35	
6100-32R-20	10	6	100	32	50	10	●	A	1.2	LH M16x2x35	
5125H-40R-20*	10	5	125	40	63	10	●	A	2.7	SH M20x2.5x40	
7125-40R-20	10	7	125	40	63	10	●	A	2.5	SH M20x2.5x40	
6160H-40R-20*	10	6	160	40	63	10	x	C	2.7	-	
8160-40R-20	10	8	160	40	63	10	x	C	3.8	-	
8200H-60R-20*	10	8	200	60	63	10	x	C	5.3	-	
9250H-60R-20*	10	9	250	60	63	10	x	C	9.3	-	

- Крепежные болты с каналом под СОЖ доступны по запросу (Пример заказа: SH M10x1.5x30-C)
- *: Твердосплавная опорная пластина

Запчасти

Обозначение	Опорная пластина	Винт опорной пластины	Винт	Ключ	
TFMRY-16		-	TS 50115I	T-T20	
TFMRY-20	-	-	TS 60A130I	SW6-T, BLD T25/M7	
TFMRY...H-16	TSRY 16NS	TS 8050088S	TS 50A140I	T-T20	
TFMRY...H-20	TSRY 20NS	TS 9060011S	TS 60A165I	SW6-T, BLD T25/M7	

 Режимы резания E241-E243	 Исполнение корпуса E244-E245	 Углы врезания E287
---------------------------------	-------------------------------------	---------------------------

TFMRN-12CH

CHASESPEED

Торцевая фреза

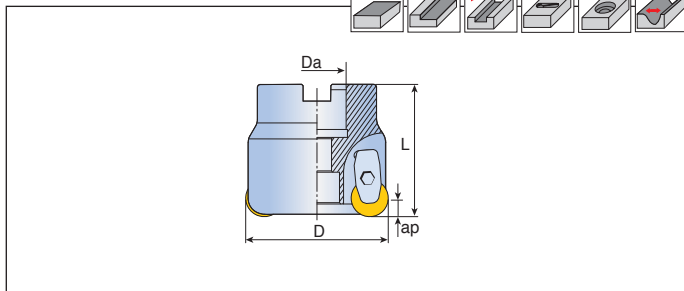
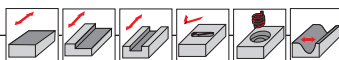

Обозначение		Размеры (мм)				Исполнение корпуса	Kg	Крепежный болт	Пластина
		D	Da	L	ap				
TFMRN 350-22R-12CH	3	50	22	50	6	A	0.4	SH M10x1.5x30	RNGX 1207-CH E216
450-22R-12CH	4	50	22	50	6	A	0.3	SH M10x1.5x30	
463-22R-12CH	4	63	22	50	6	A	0.5	SH M10x1.5x30	
580-27R-12CH	5	80	27	50	6	A	0.9	SH M12x1.75x35	

Запчасти

Обозначение	Прихват	Винт	Скрепление	Ключ	
TFMRN-12CH	CCL-5S	CLS 3C	CSR 2	T-W 3	

Режимы резания

E241-E243

Исполнение корпуса

E244-E245

TFMBL-06



Торцевая фреза

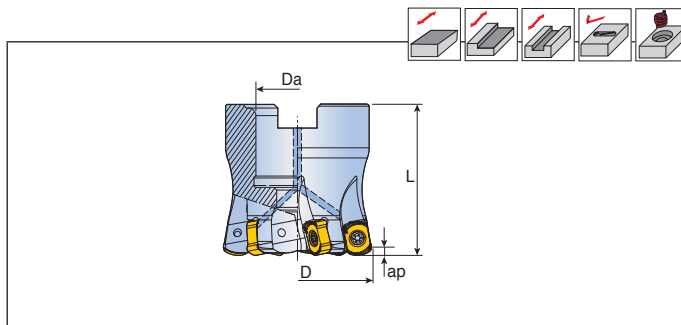

Обозначение		Размеры (мм)				Каналы СОЖ	Исполнение корпуса	Кg	Крепежный болт	Пластина
		D	Da	L	ap					
TFMBL 432-16R-06	4	32	16	40	1	●	A	0.1	SH M8x1.25x25	BLMP 0603...
532-16R-06	5	32	16	40	1	●	A	0.1	SH M8x1.25x25	
640-16R-06	6	40	16	40	1	●	A	0.2	SH M8x1.25x25	
640-22R-06	6	40	22	40	1	●	A	0.2	SH M10x1.5x30	
650-22R-06	6	50	22	50	1	●	A	0.4	SH M10x1.5x30	
750-22R-06	7	50	22	50	1	●	A	0.4	SH M10x1.5x30	
850-22R-06	8	50	22	50	1	●	A	0.4	SH M10x1.5x30	
752-22R-06	7	52	22	40	1	●	A	0.4	SH M10x1.5x30	
852-22R-06	8	52	22	40	1	●	A	0.4	SH M10x1.5x30	
763-22R-06	7	63	22	50	1	●	A	0.6	SH M10x1.5x30	
863-22R-06	8	63	22	50	1	●	A	0.6	SH M10x1.5x30	
963-22R-06	9	63	22	50	1	●	A	0.6	SH M10x1.5x30	
966-27R-06	9	66	27	50	1	●	A	0.7	SH M12x1.75x35	

Режимы резания E241-E243	Исполнение корпуса E244-E245	Углы врезания E277
---------------------------------	-------------------------------------	---------------------------

Торцевая фреза



Обозначение		Размеры (мм)				Каналы СОЖ	Исполнение корпуса	Kg	Крепежный болт	Пластина
		D	Da	L	ap					
TFMBL 432-16R-09	4	32	16	40	1.5	●	E	0.1	КТВ 32В	BLMP 0904... E206
440-16R-09	4	40	16	40	1.5	●	A	0.2	SH M8x1.25x25	
540-16R-09	5	40	16	40	1.5	●	A	0.2	SH M8x1.25x25	
550-22R-09	5	50	22	50	1.5	●	A	0.4	SH M10x1.5x30	
650-22R-09	6	50	22	50	1.5	●	A	0.4	SH M10x1.5x30	
750-22R-09	7	50	22	50	1.5	●	A	0.4	SH M10x1.5x30	
652-22R-09	6	52	22	40	1.5	●	A	0.4	SH M10x1.5x30	
752-22R-09	7	52	22	40	1.5	●	A	0.4	SH M10x1.5x30	
663-22R-09	6	63	22	50	1.5	●	A	0.6	SH M10x1.5x30	
763-22R-09	7	63	22	50	1.5	●	A	0.6	SH M10x1.5x30	
863-22R-09	8	63	22	50	1.5	●	A	0.6	SH M10x1.5x30	
766-27R-09	7	66	27	50	1.5	●	A	0.7	SH M12x1.75x35	
866-27R-09	8	66	27	50	1.5	●	A	0.8	SH M12x1.75x35	
780-27R-09	7	80	27	50	1.5	●	A	1.2	SH M12x1.75x35	
880-27R-09	8	80	27	50	1.5	●	A	1.2	SH M12x1.75x35	
980-27R-09	9	80	27	50	1.5	●	A	1.2	SH M12x1.75x35	
1080-27R-09	10	80	27	50	1.5	●	A	1.2	SH M12x1.75x35	
8100-32R-09	8	100	32	60	1.5	●	A	2.3	SH M16x2.0x35	
9100-32R-09	9	100	32	60	1.5	●	A	2.3	SH M16x2.0x35	
10100-32R-09	10	100	32	60	1.5	●	A	2.3	SH M16x2.0x35	
11100-32R-09	11	100	32	60	1.5	●	A	2.3	SH M16x2.0x35	
12100-32R-09	12	100	32	60	1.5	●	A	2.3	SH M16x2.0x35	
12125-40R-09	12	125	40	60	1.5	●	A	2.7	SH M20x2.5x40	
14125-40R-09	14	125	40	60	1.5	●	A	2.7	SH M20x2.5x40	

<p>Режимы резания E241-E243</p>	<p>Исполнение корпуса E244-E245</p>	<p>Углы врезания E278</p>
-------------------------------------	---	-------------------------------

Торцевая фреза

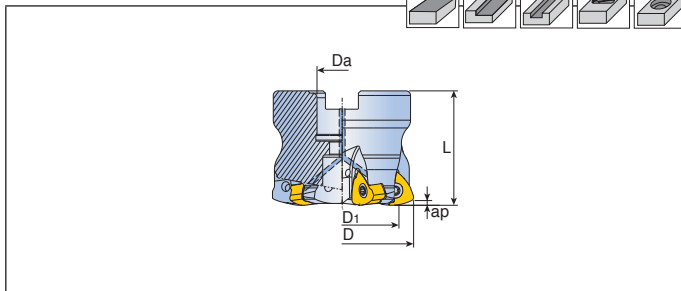
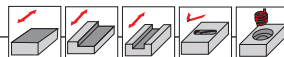

Обозначение		Размеры (мм)					Каналы СОЖ	Исполнение корпуса		Крепежный болт	Пластина
		D	D1	Da	L	ap					
TFMBL 340-16R-13	3	40	20.7	16	50	2	●	A	0.2	КТВ 32В	BLMP 1306... E207
350-22R-13	3	50	31.0	22	40	2	●	A	0.3	LH M10x1.5x25	
450-22R-13	4	50	31.0	22	40	2	●	A	0.3	LH M10x1.5x25	
452-22R-13	4	52	32.2	22	40	2	●	A	0.3	SH M10x1.5x30	
463-22R-13	4	63	45.8	22	50	2	●	A	0.8	SH M10x1.5x30	
563-22R-13	5	63	45.8	22	50	2	●	A	0.8	SH M10x1.5x30	
466-22R-13	4	66	45.9	22	50	2	●	A	0.8	SH M10x1.5x30	
566-22R-13	5	66	45.9	22	50	2	●	A	0.8	SH M10x1.5x30	
463-27R-13	4	63	45.8	27	50	2	●	A	0.7	SH M12x1.75x30	
566-27R-13	5	66	45.9	27	50	2	●	A	0.7	SH M12x1.75x30	
580-27R-13	5	80	59.8	27	60	2	●	A	1.4	SH M12x1.75x30	
680-27R-13	6	80	59.8	27	60	2	●	A	1.4	SH M12x1.75x30	
580-32R-13	5	80	59.8	32	60	2	●	A	1.4	SH M16x2x35	
5100-32R-13	5	100	79.7	32	60	2	●	A	1.9	SH M16x2x35	
6100-32R-13	6	100	79.7	32	60	2	●	A	2.0	SH M16x2x35	
7100-32R-13	7	100	79.7	32	60	2	●	A	2.0	SH M16x2x35	
6125-32R-13	6	125	104.5	32	60	2	●	A	3.0	SH M16x2x35	
7125-40R-13	7	125	104.5	40	60	2	●	A	2.9	SH M20x2.5x40	
7160-40R-13	7	160	139.5	40	60	2	×	C	3.6	-	
8160-40R-13	8	160	139.5	40	60	2	×	C	3.6	-	
9160-40R-13	9	160	139.5	40	60	2	×	C	3.8	-	
8200-60R-13	8	200	179.5	60	60	2	×	C	5.4	-	
9200-60R-13	9	200	179.5	60	60	2	×	C	5.3	-	
11200-60R-13	11	200	179.5	60	60	2	×	C	5.5	-	
9250-60R-13	9	250	229.5	60	60	2	×	C	10.6	-	
10250-60R-13	10	250	229.5	60	60	2	×	C	10.6	-	
12250-60R-13	12	250	229.5	60	60	2	×	C	10.7	-	



• Крепежные болты с каналом под СОЖ доступны по запросу (Пример заказа: SH M10x1.5x30-C)

TFMBL-13

Торцевая фреза (дюйм)

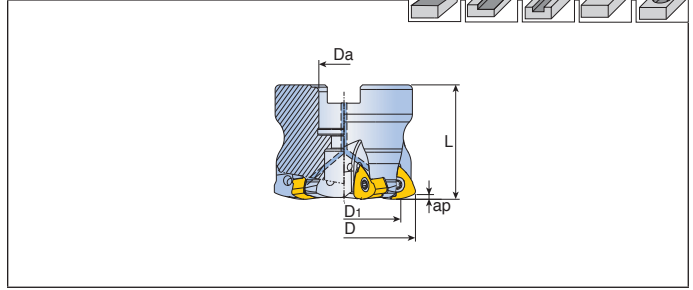
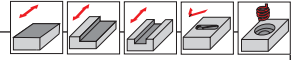

Обозначение	Z	Размеры (мм)					Каналы СОЖ	Исполнение корпуса	Kg	Крепежный болт	Пластина
		D	D1	Da	L	ap					
TFMBL 580-25.4R-13	5	80	59.8	25.4	60	2	●	A	1.3	SH M12x1.75x30	BLMP 1306...
580-31.75R-13	5	80	59.8	31.75	60	2	●	A	1.3	SH M16x2x35	E207
6100-31.75R-13	6	100	79.7	31.75	60	2	●	A	1.9	SH M16x2Xx35	
7125-38.1R-13	7	125	104.5	38.1	60	2	x	B	3.0	-	

• Крепежные болты с каналом под СОЖ доступны по запросу (Пример заказа: SH M10x1.5x30-C)

Запчасти

Обозначение	Винт	Ключ			
TFMBL-06	TS 25064I/SG	TD 8P			
TFMBL-09	TS 35A088I/HG	TD 10P			
TFMBL-13	TS 50B106I/HG	T-T20			

 Режимы резания E241-E243	 Исполнение корпуса E244-E245	 Углы врезания E279
---------------------------------	-------------------------------------	---------------------------

Торцевая фреза

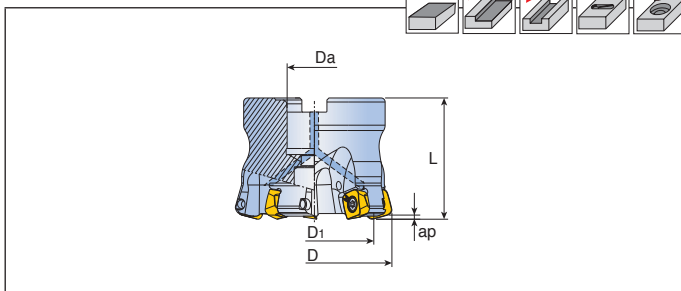
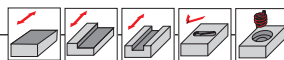

Обозначение		Размеры (мм)					Каналы СОЖ	Исполнение корпуса	Кг	Крепежный болт	Пластина
		D	D1	Da	L	ap					
TFMSB 350-22R-13	3	50	29.3	22	40	2	●	A	0.3	LH M10x1.5x25	SBMT 1306...
450-22R-13	4	50	29.3	22	40	2	●	A	0.2	LH M10x1.5x25	E220
452-22R-13	4	52	31.3	22	40	2	●	A	0.3	LH M10x1.5x25	
552-22R-13	5	52	31.3	22	40	2	●	A	0.2	LH M10x1.5x25	
463-22R-13	4	63	42.4	22	50	2	●	A	0.6	SH M10x1.5x30	
563-22R-13	5	63	42.4	22	50	2	●	A	0.5	SH M10x1.5x30	
463-27R-13	4	63	42.4	27	50	2	●	A	0.5	SH M12x1.75x35	
566-27R-13	5	66	45.3	27	50	2	●	A	0.6	SH M12x1.75x35	
580-27R-13	5	80	59.4	27	60	2	●	A	1.3	SH M12x1.75x35	
680-27R-13	6	80	59.4	27	60	2	●	A	1.3	SH M12x1.75x35	
580-32R-13	5	80	59.4	32	60	2	●	A	1.3	SH M16x2x35	
6100-32R-13	6	100	79.4	32	60	2	●	A	1.9	SH M16x2x35	
7125-40R-13	7	125	104.7	40	60	2	●	A	2.5	SH M20x2.5x40	
8160-40R-13	8	160	139.4	40	60	2	x	B	3.5	-	
9200-60R-13	9	200	179.4	60	60	2	x	B	5.1	-	
10250-60R-13	10	250	229.4	60	60	2	x	B	9.1	-	
TFMSB 463-25.4R-13	4	63	42.4	25.4	50	2	●	A	0.5	SH M12x1.75x35	
580-25.4R-13	5	80	59.4	25.4	60	2	●	A	1.3	SH M12x1.75x35	
580-31.75R-13	5	80	59.4	31.75	60	2	●	A	1.3	SH M16x2x35	
7125-38.1R-13	7	125	104.7	38.1	60	2	x	B	2.2	-	

• Крепежные болты с каналом под СОЖ доступны по запросу (Пример заказа: SH M10x1.5x30-C)

Запчасти

Обозначение	Винт	Ключ			
	TFMSB-13	TS 501151	T-T20		

Режимы резания E241-E243	Исполнение корпуса E244-E245	Углы врезания E280
-----------------------------	---------------------------------	-----------------------

3P TE90-06

MILL-RUSH

Концевая фреза

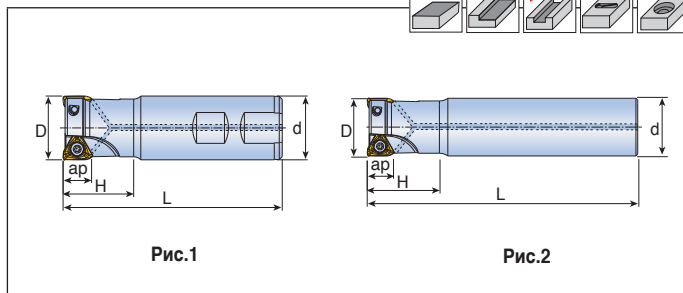
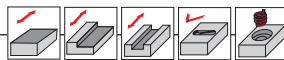

Обозначение	⊙	Размеры (мм)					Каналы СОЖ	Рис.	Пластина
		D	d	L	H	ap			
3P TE90-112-12-06-L80	1	12	12	80	20	4.7	●	2	3PK(H)T 0603... E194
114-12-06-L80	1	14	12	80	20	4.7	●	2	
216-W16-06	2	16	16	90	25	4.7	●	1	
216-16-06-L110	2	16	16	110	25	4.7	●	2	
216-16-06-L150	2	16	16	150	25	4.7	●	2	
317-16-06-L110	3	17	16	110	25	4.7	●	2	
318-W16-06	3	18	16	90	25	4.7	●	1	
318-16-06-L150	3	18	16	150	25	4.7	●	2	
319-16-06-L150	3	19	16	150	25	4.7	●	2	
320-W20-06	3	20	20	105	25	4.7	●	1	
420-W20-06	4	20	20	105	25	4.7	●	1	
320-20-06-L160	3	20	20	160	25	4.7	●	2	
420-19-06-L160	4	20	19	160	25	4.7	●	2	
421-20-06-L160	4	21	20	160	25	4.7	●	2	
422-W20-06	4	22	20	110	25	4.7	●	1	
425-W20-06	4	25	20	115	25	4.7	●	1	
525-W20-06	5	25	20	115	25	4.7	●	1	
525-W25-06	5	25	25	115	25	4.7	●	1	
630-W25-06	6	30	25	130	30	4.7	●	1	
632-W25-06	6	32	25	130	30	4.7	●	1	
732-W25-06	7	32	25	130	30	4.7	●	1	
840-W32-06	8	40	32	130	30	4.7	●	1	



3P TE90-10

MILL-RUSH

Концевая фреза



90°

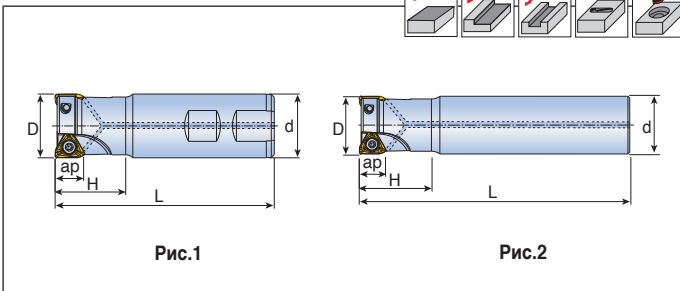
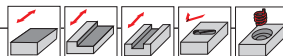

Обозначение	⊕	Размеры (мм)					Каналы СОЖ	Рис.	Пластина
		D	d	L	H	ap			
3P TE90-116-W16-10	1	16	16	90	20	7	●	1	3PK(H)T 1004... E194
220-W20-10	2	20	20	90	25	7	●	1	
220-19-10-L170	2	20	19	170	30	7	x	2	
220-20-10-L170	2	20	20	170	40	7	x	2	
221-20-10-L200	2	21	20	200	30	7	x	2	
222-W20-10	2	22	20	100	25	7	●	1	
225-25-10-L210	2	25	25	210	40	7	x	2	
325-W20-10	3	25	20	100	30	7	●	1	
325-W25-10	3	25	25	100	30	7	●	1	
325-24-10-L210	3	25	24	210	35	7	x	2	
325-25-10-L210	3	25	25	210	40	7	x	2	
226-25-10-L250	2	26	25	250	30	7	x	2	
330-W25-10	3	30	25	110	35	7	●	1	
232-W25-10	2	32	25	110	35	7	●	1	
332-W25-10	3	32	25	110	35	7	●	1	
332-32-10-L250	3	32	32	250	60	7	x	2	
432-W32-10	4	32	32	110	40	7	●	1	
532-W32-10	5	32	32	110	40	7	●	1	
333-32-10-L250	3	33	32	250	35	7	x	2	
440-32-10-L200	4	40	32	200	40	7	x	2	
540-W32-10	5	40	32	115	40	7	●	1	
640-W32-10	6	40	32	115	40	7	●	1	

Режимы резания
E241-E243

Углы врезания
E260-E261

3P TE90-15/19

MILL-RUSH

Концевая фреза

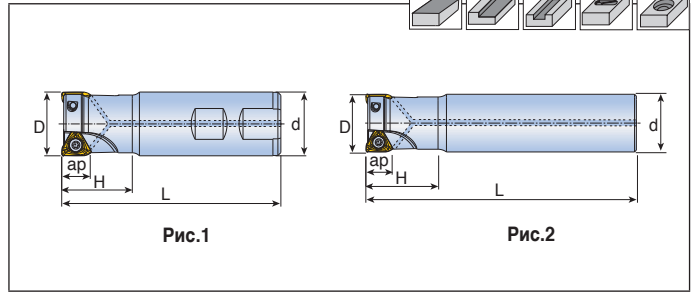
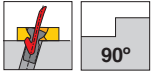
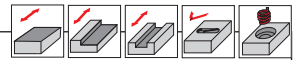

Обозначение	⊙	Размеры (мм)					Каналы СОЖ	Рис.	Пластина
		D	d	L	H	ap			
3P TE90-232-W32-15	2	32	32	110	40	11	●	1	3PK(H)T 1505... E194-E195
232-32-15-L250	2	32	32	250	60	11	x	2	
332-W25-15	3	32	25	100	40	11	●	1	
332-W25-15-L155	3	32	25	155	35	11	x	2	
332-W32-15	3	32	32	110	40	11	●	1	
332-32-15-L150	3	32	32	150	40	11	x	2	
332-32-15-L250	3	32	32	250	60	11	x	2	
233-32-15-L200	2	33	32	200	40	11	x	2	
233-32-15-L250	2	33	32	250	40	11	x	2	
335-W32-15	3	35	32	110	40	11	●	1	
340-W32-15	3	40	32	110	40	11	●	1	
340-32-15-L200	3	40	32	200	40	11	x	2	
440-W32-15	4	40	32	110	40	11	●	1	
3P TE90-240-32-19-L250	2	40	32	250	45	15	x	2	
340-W32-19	3	40	32	115	45	15	●	1	
340-32-19-L200	3	40	32	200	45	15	x	2	
450-W32-19	4	50	32	115	45	15	●	1	

Режимы резания
E241-E243

Ramping Data
E260-E261

Модульная головка

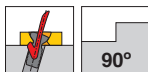
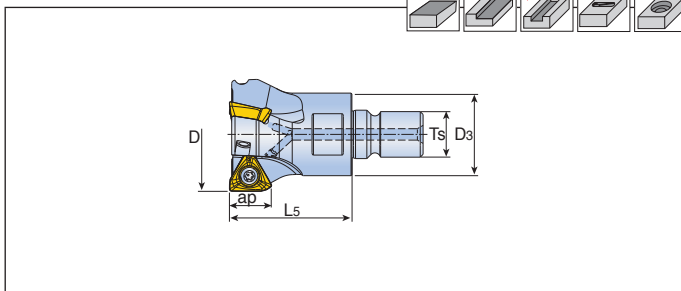
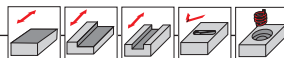

Обозначение		Размеры (мм)					Каналы СОЖ	Пластина
		D	D3	L5	Ts	ap		
3P TE90-216-M08-06	2	16	13	23	8	4.7	●	3PK(H)T 0603...
320-M10-06	3	20	18	35	10	4.7	●	E194
420-M10-06	4	20	18	35	10	4.7	●	
425-M12-06	4	25	21	35	12	4.7	●	
525-M12-06	5	25	21	35	12	4.7	●	
632-M16-06	6	32	29	43	16	4.7	●	
732-M16-06	7	32	29	43	16	4.7	●	
735-M16-06	7	35	29	43	16	4.7	●	
3P TE90-220-M10-10	2	20	18	35	10	7	●	3PK(H)T 1004...
325-M12-10	3	25	21	35	12	7	●	E194
326-M12-10	3	26	21	35	12	7	●	
432-M16-10	4	32	29	43	16	7	●	
532-M16-10	5	32	29	43	16	7	●	
535-M16-10	5	35	29	43	16	7	●	
540-M16-10	5	40	29	43	16	7	●	
640-M16-10	6	40	29	43	16	7	●	
642-M16-10	6	42	29	43	16	7	●	
3P TE90-232-M16-15	2	32	29	43	16	11	●	3PK(H)T 1505...
332-M16-15	3	32	29	43	16	11	●	E194-E195
340-M16-15	3	40	29	43	16	11	●	
440-M16-15	4	40	29	43	16	11	●	
3P TE90-340-M16-19	3	40	29	43	16	15	●	3PK(H)T 1906...
								E194-E195

• устанавливается на хвостовик T-FLEXTEC: см. раздел G

Запчасти

Обозначение	Винт	Ключ			
3P TE90-06	TS 20043I/HG-P	TD6P			
3P TE90-10	TS 25C065I/HG	TD8			
3P TE90-15	TS 40B100I	TD15			
3P TE90-19	TS 45120I	T-T20			

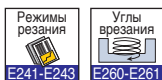

Концевая фреза

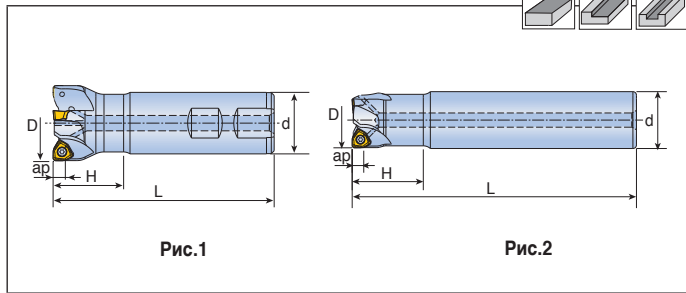
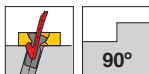
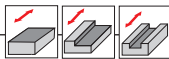

Обозначение	✳	Размеры (мм)					Каналы СОЖ	Рис.	Пластина
		D	d	L	H	ap			
6N TE90-320-W20-04	3	20	20	90	30	4.1	●	1	6NKU 0403... E197
320-20-04-L160	3	20	20	160	30	4.1	●	2	
425-25-04-L170	4	25	25	170	30	4.1	●	2	
525-W25-04	5	25	25	100	35	4.1	●	1	
532-32-04-L200	5	32	32	200	40	4.1	●	2	
632-W32-04	6	32	32	110	40	4.1	●	1	
6N TE90-225-W25-06	2	25	25	100	30	6.2	●	1	6NGU 0604... E196
225-25-06 -L150	2	25	25	150	30	6.2	●	2	
232-W32-06	2	32	32	110	40	6.2	●	1	
232-32-06 -L160	2	32	32	160	40	6.2	●	2	
332-W32-06	3	32	32	110	40	6.2	●	1	
332-32-06 -L160	3	32	32	160	40	6.2	●	2	
340-W32-06	3	40	32	115	40	6.2	●	1	
340-32-06-L200	3	40	32	200	40	6.2	●	2	
440-W32-06	4	40	32	115	40	6.2	●	1	
6N TE90-232-W32-09	2	32	32	110	40	9.2	●	1	6NGU 0905... E196
232-32-09-L160	2	32	32	160	60	9.2	●	2	
340-W32-09	3	40	32	120	40	9.2	●	1	
340-32-09-L200	3	40	32	200	40	9.2	●	2	
440-W32-09	4	40	32	120	40	9.2	●	1	



6N TE90-...-M...-04/06/09



Модульная головка

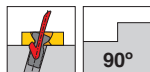
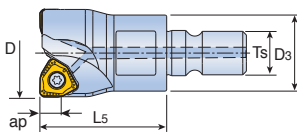
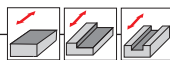

Обозначение		Размеры (мм)					Каналы СОЖ	Пластина
		D	Dз	L5	Ts	ap		
6N TE90-320-M10-04	3	20	18	35	10	4.1	•	6N KU 0403...
525-M12-04	5	25	21	35	12	4.1	•	E197
632-M16-04	6	32	29	43	16	4.1	•	
6N TE90-225-M12-06	2	25	21	35	12	6.2	•	6N GU 0604...
332-M16-06	3	32	29	43	16	6.2	•	E196
440-M16-06	4	40	29	43	16	6.2	•	
6N TE90-232-M16-09	2	32	29	43	16	9.2	•	6N GU 0905...
340-M16-09	3	40	29	43	16	9.2	•	E196
440-M16-09	4	40	29	43	16	9.2	•	

• устанавливается на хвостовик T-FLEXTEC: см. раздел G

Запчасти

Обозначение	Винт	Ключ			
6N TE90-04	TS 25064I	TD 8			
6N TE90-06	TS 30085I/HG	TD9			
6N TE90-09	TS 40B100I	TD15			



SCRM90TN...-W...-18



Концевая фреза

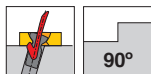
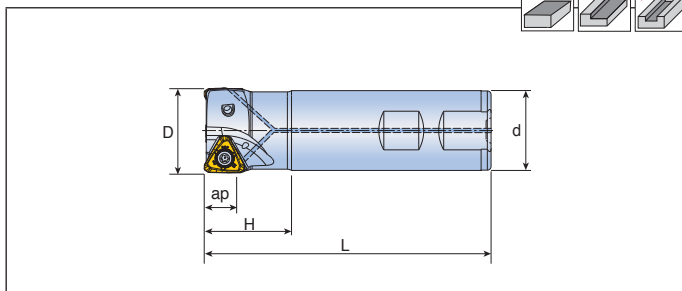
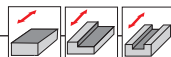

Обозначение	✶	Размеры (мм)					Каналы СОЖ	Пластина
		D	d	L	H	ap		
SCRM90TN 235-W32-18	2	35	32	115	35	13	•	TNMX 1806...
340-W32-18	3	40	32	115	35	13	•	E233



SCRM90TN...-M...-18



Модульная головка

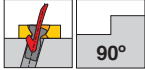
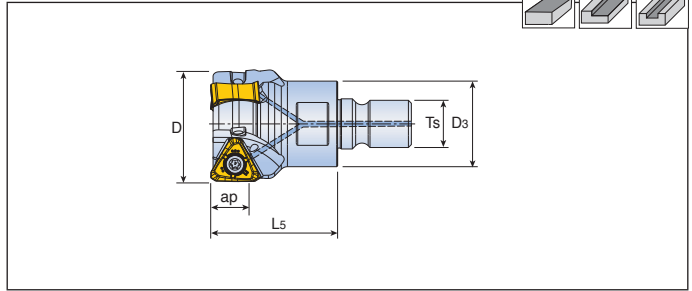
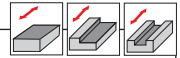

Обозначение	⊙	Размеры (мм)					Каналы СОЖ	Пластина
		D	Dз	L5	Ts	ap		
SCRM90TN 235-M16-18	2	35	29	43	16	13	•	TNMX 1806...
340-M16-18	3	40	29	43	16	13	•	E233

• устанавливается на хвостовик T-FLEXTEC: см. раздел G

Запчасти

Обозначение	Винт	Ключ			
	SCRM90TN-18	TS 40B1001	T-T15		



TE90AX-06

Концевая фреза

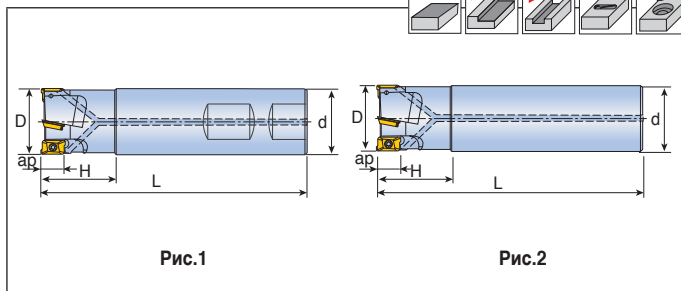
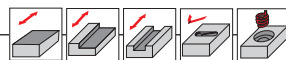

Обозначение	🌀	Размеры (мм)					Каналы СОЖ	Рис.	Пластина
		D	d	L	H	ap			
TE90AX 108-08-06-C	1	8	8	80	17	5.5	●	2	AXM(C)T 0602 ... E205
210-09-06-L120	2	10	9	120	17	5.5	x	2	
210-10-06	2	10	10	80	17	5.5	x	2	
210-10-06-C	2	10	10	80	17	5.5	●	2	
211-10-06	2	11	10	80	17	5.5	x	2	
212-12-06	2	12	12	80	18	5.5	x	2	
212-12-06-C	2	12	12	80	18	5.5	●	2	
212-12-06-L	2	12	12	130	18	5.5	x	2	
212-11-06-L120	2	12	11	120	20	5.5	x	2	
312-12-06	3	12	12	80	18	5.5	x	2	
312-12-06-C	3	12	12	80	18	5.5	●	2	
313-12-06-C	3	13	12	90	20	5.5	●	2	
314-12-06	3	14	12	80	18	5.5	x	2	
415-12-06	4	15	12	80	18	5.5	x	2	
316-16-06	3	16	16	110	20	5.5	x	2	
316-16-06-C	3	16	16	110	20	5.5	●	2	
316-16-06-L	3	16	16	150	20	5.5	x	2	
416-W16-06	4	16	16	90	20	5.5	x	1	
416-W16-06-C	4	16	16	90	20	5.5	●	1	
417-16-06	4	17	16	90	20	5.5	x	2	
418-W16-06	4	18	16	90	20	5.5	x	1	
418-W16-06-C	4	18	16	90	20	5.5	●	1	
418-16-06-L	4	18	16	150	20	5.5	x	2	
419-W16-06	4	19	16	90	20	5.5	x	1	
420-20-06	4	20	20	160	25	5.5	x	2	
420-W20-06-C	4	20	20	160	25	5.5	●	1	
520-19-06-L	5	20	19	160	25	5.5	x	1	
520-W20-06	5	20	20	105	25	5.5	x	1	
520-W20-06-C	5	20	20	105	25	5.5	●	1	
521-20-06	5	21	20	105	25	5.5	x	2	
725-W20-06	7	25	20	115	25	5.5	x	1	
725-W20-06-C	7	25	20	115	25	5.5	●	1	
725-W25-06	7	25	25	120	30	5.5	x	1	
832-W25-06	8	32	25	130	32	5.5	x	1	
832-W25-06-C	8	32	25	130	32	5.5	●	1	
1040-W32-06	10	40	32	140	40	5.5	x	1	
1040-W32-06-C	10	40	32	140	40	5.5	●	1	

Модульная головка

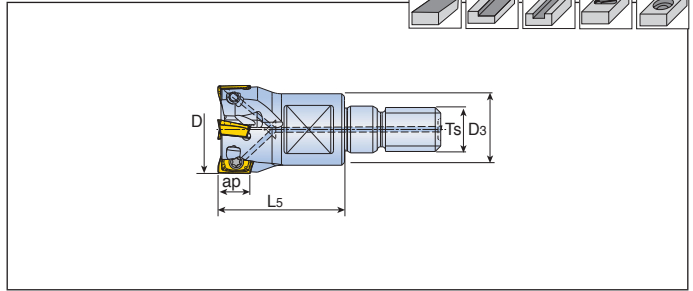
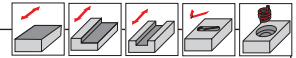

Обозначение		Размеры (мм)					Каналы СОЖ	Пластина
		D	D3	L5	Ts	ap		
TE90AX 210-M06-06	2	10	9.68	23	6	5.5	●	AXM(C)T 0602... E205
312-M06-06	3	12	9.68	23	6	5.5	●	
416-M08-06	4	16	13	23	8	5.5	●	
520-M10-06	5	20	18	30	10	5.5	●	
725-M12-06	7	25	21	35	12	5.5	●	
832-M16-06	8	32	29	43	16	5.5	●	
1040-M16-06	10	40	29	43	16	5.5	●	

- устанавливается на хвостовик T-FLEXTEC: см. раздел G
- Корпус фрезы для пластины "AXMT 06" с радиусом при вершине более 1,0 мм должен быть доработан по формуле:
Радиус корпуса = Радиус пластины - 0,1 мм

Запчасти

Обозначение	Винт	Ключ			
	TE90AX-06	 TS 18041/HG	 TD6P		

Режимы резания
E241-E243

Углы врезания
E262-E265

2S-TE90AP-09

CHASEMILL

Концевая фреза



Рис.1

Рис.2

Обозначение		Размеры (мм)					Каналы СОЖ	Рис.	Пластина
		D	d	L	H	ap			
2S-TE90AP 110-W10-09	1	10	10	80	23.5	8.8	x	1	АРК(С)Т 09Т3... E200, E205
110-W10-09-C	1	10	10	80	23.5	8.8	●	1	
112-W12-09	1	12	12	80	23.0	8.8	x	1	
112-W16-09-C	1	12	16	80	21.7	8.8	●	1	
114-W12-09	1	14	12	80	25.0	8.8	x	1	
216-15-09-L	2	16	15	170	30.0	8.8	x	2	
216-W16-09	2	16	16	90	22.1	8.8	x	1	
216-W16-09-C	2	16	16	90	22.1	8.8	●	1	
216-16-09-L	2	16	16	145	27.1	8.8	x	2	
217-16-09-L	2	17	16	180	25.0	8.8	x	2	
218-W16-09	2	18	16	90	25.0	8.8	x	1	
218-W16-09-C	2	18	16	90	25.0	8.8	●	1	
220-19-09-L	2	20	19	170	25.0	8.8	x	2	
220-20-09-L	2	20	20	170	37.1	8.8	x	2	
320-W20-09	3	20	20	110	27.1	8.8	x	1	
320-W20-09-C	3	20	20	110	27.1	8.8	●	1	
221-20-09-L	2	21	20	200	25.0	8.8	x	2	
322-W20-09	3	22	20	110	30.0	8.8	x	1	
322-W20-09-C	3	22	20	110	30.0	8.8	●	1	
225-24-09-L	2	25	24	210	28.0	8.8	x	2	
225-25-09-L	2	25	25	210	37.1	8.8	x	2	
325-W20-09	3	25	20	110	30.0	8.8	x	1	
325-W20-09-C	3	25	20	110	30.0	8.8	●	1	
325-W25-09	3	25	25	110	26.6	8.8	x	1	
425-W20-09-C	4	25	20	110	30.0	8.8	●	1	
226-25-09-L	2	26	25	250	28.0	8.8	x	2	
430-W25-09	4	30	25	130	32.0	8.8	x	1	
430-W25-09-C	4	30	25	130	30.0	8.8	●	1	
232-32-09-L	2	32	32	250	62.0	8.8	x	2	
432-W25-09	4	32	25	130	32.0	8.8	x	1	
432-W25-09-C	4	32	25	130	32.0	8.8	●	1	
532-W25-09-C	5	32	25	130	32.0	8.8	●	1	
333-32-09-L	3	33	32	250	40.0	8.8	x	2	
240-32-09-L	2	40	32	250	32.0	8.8	x	2	
540-W32-09	5	40	32	130	32.0	8.8	x	1	
540-W32-09-C	5	40	32	130	32.0	8.8	●	1	
640-W32-09	6	40	32	130	32.0	8.8	x	1	

2S-TE90AP ...-M...-09

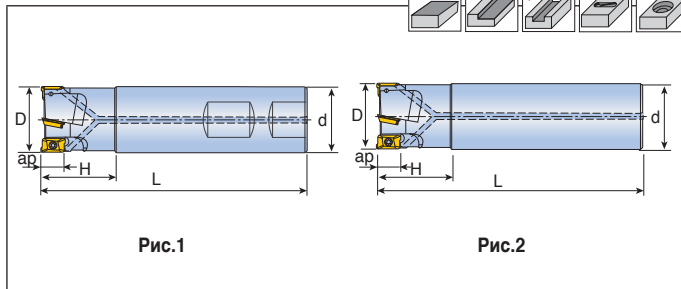
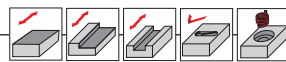
CHASEMILL

Модульная головка

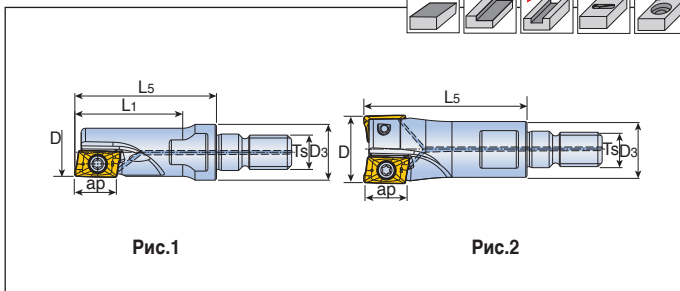
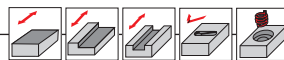

Обозначение		Размеры (мм)						Каналы СОЖ	Рис.	Пластина
		D	D3	L5	L1	Ts	ap			
2S-TE90AP 110-M06-09	1	10	9.7	33	19	6	8.8	●	1	АРК(С)Т 09Т3... E200, E205
112-M08-09	1	12	13	33	25	8	8.8	●	1	
216-M08-09	2	16	13	38	-	8	8.8	●	2	
320-M10-09	3	20	18	38	-	10	8.8	●	2	
325-M12-09	3	25	21	38	-	12	8.8	●	2	
425-M12-09	4	25	21	38	-	12	8.8	●	2	
432-M16-09	4	32	29	38	-	16	8.8	●	2	
532-M16-09	5	32	29	38	-	16	8.8	●	2	
540-M16-09	5	40	29	43	-	16	8.8	●	2	
640-M16-09	6	40	29	43	-	16	8.8	●	2	

- устанавливается на хвостовик T-FLEXTEC: см. раздел G
- Корпус фрезы для пластины 'АРКТ09' с радиусом при вершине более 2,4 мм должен быть доработан по формуле:
Радиус корпуса = Радиус пластины - 0,2 мм

Запчасти

Обозначение	Винт	Ключ			
	2S-TE90AP-09	TS 25055/HG	TD8		

Режимы резания

E241-E243

Углы врезания

E262-E265

TE90AP-12

Концевая фреза



Рис.1

Рис.2

Обозначение		Размеры (мм)					Каналы СОЖ	Рис.	Пластина
		D	d	L	H	ap			
TE90AP 116-W16-12-C	1	16	16	85	26	12	●	1	APK(C)T 1204... E201-E202,E205
218-W20-12-C	2	18	20	85	26	12	●	1	
220-19-12-L	2	20	19	170	30	12	●	2	
220-W20-12-C	2	20	20	90	30	12	●	1	
220-W20-12-L-C	2	20	20	125	30	12	●	1	
220-20-12-L	2	20	20	170	30	12	●	2	
220-20-12-L200	2	20	20	200	30	12	●	2	
221-20-12-L200	2	21	20	200	30	12	●	2	
221-20-12-L250	2	21	20	250	30	12	●	2	
225-24-12-L	2	25	24	200	40	12	●	2	
225-W25-12-L-C	2	25	25	145	40	12	●	1	
225-25-12-L	2	25	25	210	40	12	●	2	
225-25-12-L200	2	25	25	200	40	12	●	2	
325-W25-12-C	3	25	25	100	40	12	●	1	
226-25-12-L200	2	26	25	200	40	12	●	2	
226-25-12-L250	2	26	25	250	40	12	●	2	
232-25-12-L	2	32	25	250	40	12	●	2	
332-W25-12-L-C	3	32	25	155	35	12	●	1	
332-W32-12-C	3	32	32	110	40	12	●	1	
332-32-12-L	3	32	32	250	40	12	●	2	
332-32-12-L150	3	32	32	150	40	12	●	2	
432-W25-12-C	4	32	25	100	40	12	●	1	
233-32-12-L200	2	33	32	200	40	12	●	2	
233-32-12-L250	2	33	32	250	40	12	●	2	
333-32-12-L200	3	33	32	200	40	12	●	2	
333-32-12-L250	3	33	32	250	40	12	●	2	
435-W25-12	4	35	25	100	40	12	●	1	
440-W32-12-C	4	40	32	115	45	12	●	1	
440-32-12-L	4	40	32	250	40	12	●	2	
540-W32-12-C	5	40	32	115	45	12	●	1	

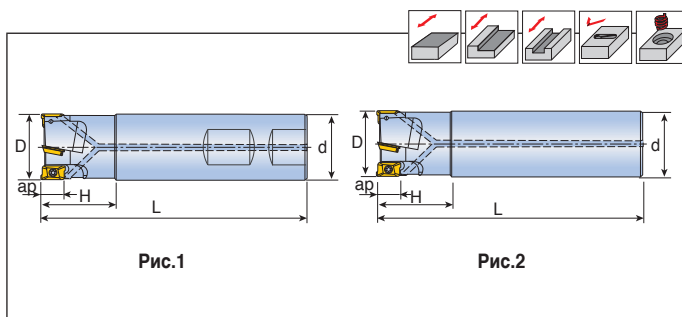

Модульная головка

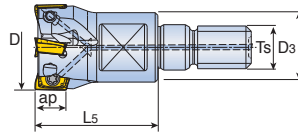
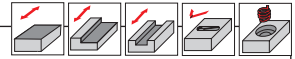

Обозначение		Размеры (мм)					ap	Каналы СОЖ	Пластина
		D	D3	L5	Ts				
TE90AP 116-M08-12	1	16	13	35	8	12	●	APK(C)T 1204... E201-E202, E205	
220-M10-12	2	20	18	35	10	12	●		
325-M12-12	3	25	21	35	12	12	●		
432-M16-12	4	32	29	43	16	12	●		
540-M16-12	5	40	29	43	16	12	●		
542-M16-12	5	42	29	43	16	12	●		

- устанавливается на хвостовик T-FLEXTEC: см. раздел G
- Корпус фрезы для пластины 'APKT 12' с радиусом при вершине более 1,6 мм должен быть доработан по формуле:
 $\text{Радиус корпуса} = \text{Радиус пластины} - 0,5 \text{ мм}$

Запчасти

Обозначение	Винт	Ключ			
TE90AP-12 (Ø16-Ø26)	TS 35A070I/HG	TD10P			
TE90AP-12 (Ø32-)	TS 35A088I/HG	TD10P			

Режимы резания

E217-E219

Углы врезания

E262-E265

TE90AP-17

Концевая фреза

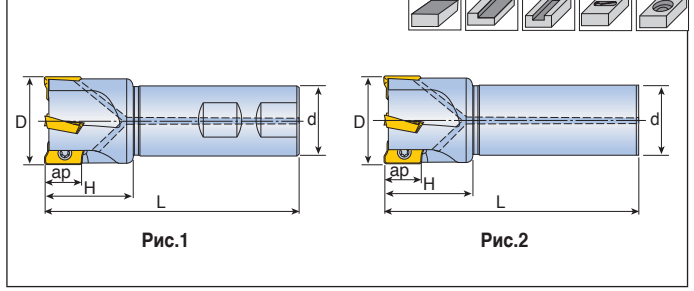
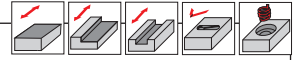

Обозначение		Размеры (мм)					Каналы СОЖ	Рис.	Пластина
		D	d	L	H	ap			
TE90AP 120-W20-17	1	20	20	90	32	16.1	x	1	АРКТ 1705/1706... E203
120-W20-17-C	1	20	20	90	32	16.1	●	1	
225-24-17-L	2	25	24	210	40	16.1	x	2	
225-W25-17	2	25	25	100	39	16.1	x	1	
225-W25-17-C	2	25	25	100	39	16.1	●	1	
225-25-17-L	2	25	25	210	40	16.1	x	2	
226-25-17-L200	2	26	25	200	40	16.1	●	2	
226-25-17-L250	2	26	25	250	40	16.1	●	2	
232-32-17-L	2	32	32	250	65	16.1	x	2	
233-32-17-L250	2	33	32	250	40	16.1	●	2	
233-32-17-L300	2	33	32	300	40	16.1	●	2	
332-W32-17	3	32	32	110	40	16.1	x	1	
332-W32-17-C	3	32	32	110	40	16.1	●	1	
332-32-17-L	3	32	32	200	65	16.1	x	2	
333-32-17-L200	3	33	32	200	55	16.1	●	2	
333-32-17-L250	3	33	32	250	55	16.1	●	2	
240-32-17-L	2	40	32	250	54	16.1	x	2	
340-W32-17	3	40	32	110	40	16.1	x	1	
340-32-17-L	3	40	32	200	54	16.1	x	2	
440-W32-17	4	40	32	115	45	16.1	x	1	
440-W32-17-C	4	40	32	115	45	16.1	●	1	
440-32-17-L	4	40	32	200	57	16.1	x	2	



Модульная головка

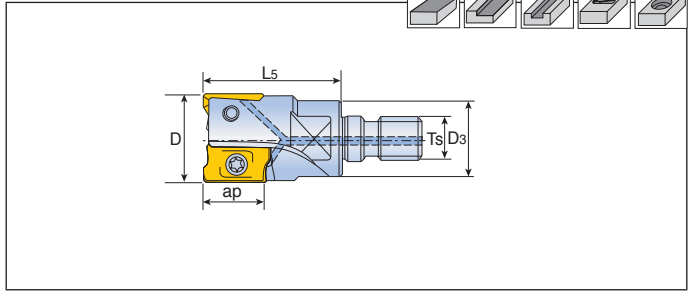
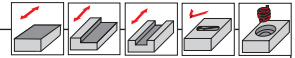

Обозначение		Размеры (мм)					Каналы СОЖ	Пластина
		D	D3	L5	Ts	ap		
TE90AP 120-M10-17	1	20	18	43	10	16.1	●	АПКТ 1705... E203
225-M12-17	2	25	21	43	12	16.1	●	
232-M16-17	2	32	29	43	16	16.1	●	
332-M16-17	3	32	29	43	16	16.1	●	
340-M16-17	3	40	29	43	16	16.1	●	
440-M16-17	4	40	29	43	16	16.1	●	

- устанавливается на хвостовик T-FLEXTEC: см. раздел G
- Корпус фрезы для пластины 'АПКТ 17' с радиусом при вершине более 1,6 мм должен быть доработан по формуле:
Радиус корпуса = Радиус пластины - 0,8 мм

Запчасти

Обозначение	Винт	Ключ			
TE90AP-17 (Ø20-Ø25)	TS 40085I/HG	TD15			
TE90AP-17 (Ø26-Ø63)	TS 40093I/HG	TD15			

Режимы резания

E241-E243

Углы врезания

E262-E265

2S-TE90AP-19

Концевая фреза

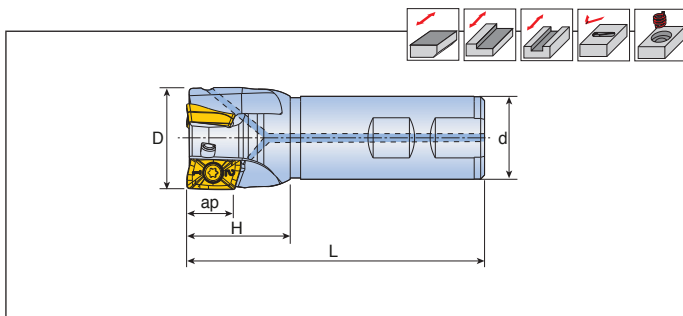

Обозначение	3	Размеры (мм)					Каналы СОЖ	Пластина
		D	d	L	H	ap		
2S-TE90AP 340-W32-19		40	32	115	40	17.9	●	АРКТ 1907... E204

Запчасти

Обозначение	Винт	Ключ			
2S-TE90AP-19	TS 501151	TD20			

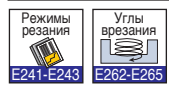

2P-TE90...-05

CHASEMILLPOWER

Концевая фреза

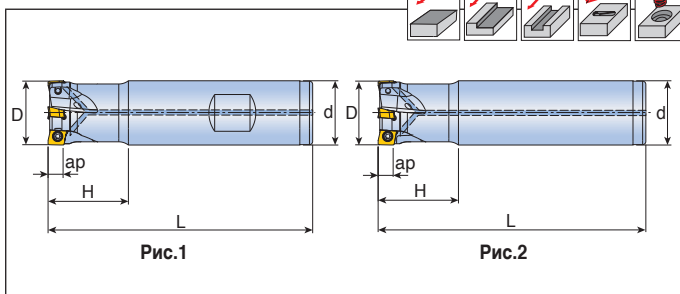
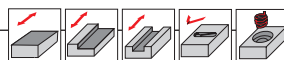

Обозначение		Размеры (мм)					Каналы СОЖ	Рис.	Пластина
		D	d	L	H	ap			
2P-TE90- 212-12-05	2	12	12	80	20	4.7	●	2	2PKT 0503... E192
212-12-05-L110	2	12	12	110	20	4.7	●	2	
213-12-05	2	13	12	80	20	4.7	●	2	
213-12-05-L110	2	13	12	110	20	4.7	●	2	
216-16-05-L150	2	16	16	150	25	4.7	●	2	
316-W16-05	3	16	16	90	25	4.7	●	1	
316-16-05-L110	3	16	16	110	25	4.7	●	2	
317-16-05-L110	3	17	16	110	25	4.7	●	2	
317-16-05-L150	3	17	16	150	25	4.7	●	2	
320-W20-05	3	20	20	105	25	4.7	●	1	
420-W20-05	4	20	20	105	25	4.7	●	1	
420-W20-05-L160	4	20	20	160	25	4.7	●	1	
421-W20-05	4	21	20	105	25	4.7	●	1	
421-20-05-L160	4	21	20	160	25	4.7	●	2	
421-20-05-L200	4	21	20	200	25	4.7	●	2	
425-W20-05	4	25	20	115	25	4.7	●	1	
425-20-05-L200	4	25	20	200	25	4.7	●	2	
525-W20-05	5	25	20	115	25	4.7	●	1	
525-25-05-L160	5	25	25	160	25	4.7	●	2	
525-25-05-L200	5	25	25	200	25	4.7	●	2	
625-W25-05	6	25	25	115	25	4.7	●	1	
526-25-05-L200	5	26	25	200	25	4.7	●	2	
626-25-05-L160	6	26	25	160	25	4.7	●	2	
632-W25-05	6	32	25	130	30	4.7	●	1	
632-25-05-L200	6	32	25	200	30	4.7	●	2	
732-W25-05	7	32	25	130	30	4.7	●	1	
633-25-05-L200	6	33	25	200	30	4.7	●	2	

Режимы
резания

E241-E243

Углы
врезания

E268

2P-TE90...-M...-05

CHASEMILLPOWER

Модульная головка

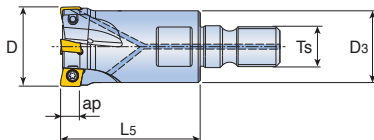
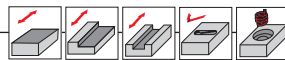

90°

Обозначение		Размеры (мм)					Каналы СОЖ	Пластина
		D	Dз	L5	Ts	ap		
2P-TE90-212-M06-05	2	12	9.7	23	6	4.7	●	2PKT 0503... E192
213-M06-05	2	13	11	23	6	4.7	●	
316-M08-05	3	16	13	23	8	4.7	●	
317-M08-05	3	17	13	23	8	4.7	●	
420-M10-05	4	20	18	35	10	4.7	●	
421-M12-05	4	21	21	35	12	4.7	●	
525-M12-05	5	25	21	35	12	4.7	●	
625-M12-05	6	25	21	35	12	4.7	●	
626-M12-05	6	26	21	35	12	4.7	●	
732-M16-05	7	32	29	43	16	4.7	●	
733-M16-05	7	33	29	43	16	4.7	●	

• устанавливается на хвостовик T-FLEXTEC: см. раздел **G**

Запчасти

Обозначение	Винт	Ключ			
2P-TE90-05	TS 20043I/HG-P	TD 6P			



TE90AN-11/16

Концевая фреза

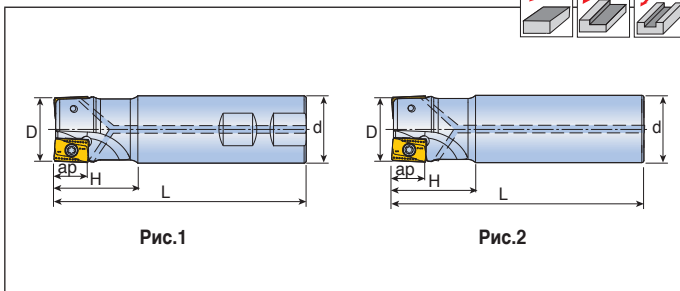
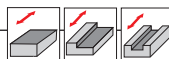

Обозначение	Симметричность	Размеры (мм)					Каналы СОЖ	Рис.	Пластина
		D	d	L	H	ap			
TE90AN 225-24-11-L	2	25	24	200	40	11	●	2	ANM(H)X 1106... E199
225-W25-11	2	25	25	100	40	11	●	1	
225-25-11-L	2	25	25	200	40	11	●	2	
226-25-11-L	2	26	25	200	40	11	●	2	
332-W32-11	3	32	32	110	40	11	●	1	
332-32-11-L	3	32	32	200	40	11	●	2	
233-32-11-L	2	33	32	250	40	11	●	2	
333-32-11-L	3	33	32	200	40	11	●	2	
340-32-11-L	3	40	32	250	40	11	●	2	
440-W32-11	4	40	32	115	40	11	●	1	
440-32-11-L	4	40	32	200	40	11	●	2	
TE90AN 232-W32-16	2	32	32	110	30	15	●	1	ANM(H)X 1607... E199
232-32-16	2	32	32	150	45	15	●	2	
232-32-16-L250	2	32	32	250	40	15	●	2	
233-32-16-L200	2	33	32	200	55	15	●	2	
340-W32-16	3	40	32	115	35	15	●	1	
340-32-16	3	40	32	150	45	15	●	2	
340-32-16-L250	3	40	32	250	45	15	●	2	
450-32-16	4	50	32	150	50	15	●	2	

Режимы резания

E241-E243

Углы врезания

E269

TE90AN...-M...-11/16

Модульная головка

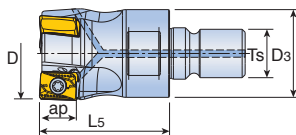
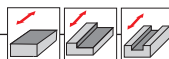

Обозначение		Размеры (мм)					Каналы СОЖ	Пластина
		D	Dз	L5	Ts	ap		
TE90AN 225-M12-11	2	25	21	35	12	11	●	ANM(H)X 1106...
332-M16-11	3	32	29	43	16	11	●	E199
440-M16-11	4	40	29	43	16	11	●	
TE90AN 232-M16-16	2	32	29	43	16	15	●	ANM(H)X 1607...
340-M16-16	3	40	29	43	16	15	●	E199

• устанавливается на хвостовик T-FLEXTEC: см. раздел G

Запчасти

Обозначение	Винт	Ключ			
TE90AN-11	TS 35A088/HG	TD10P			
TE90AN-16	TS 40120I	TD15			



4N TE90-06



Концевая фреза



Рис.1

Рис.2



Обозначение	Z	Размеры (мм)					Каналы СОЖ	Рис.	Пластина	
		D	d	L	H	ap				
4N TE90-216-15-06-L150	2	16	15	150	25	6	●	2	4NKT 0603..... E195	
216-W16-06	2	16	16	90	25	6	●	1		
216-16-06-L100	2	16	16	100	25	6	●	2		
216-16-06-L150	2	16	16	150	25	6	●	2		
217-16-06	2	17	16	90	25	6	●	2		
217-16-06-L200	2	17	16	200	25	6	●	2		
218-W16-06	2	18	16	90	25	6	●	1		
218-16-06-L150	2	18	16	150	25	6	●	2		
220-19-06-L160	2	20	19	160	25	6	●	2		
220-W20-06	2	20	20	90	25	6	●	1		
220-20-06-L110	2	20	20	110	25	6	●	2		
220-20-06-L160	2	20	20	160	25	6	●	2		
320-W20-06	3	20	20	90	25	6	●	1		
320-20-06-L110	3	20	20	110	25	6	●	2		
221-20-06-L200	2	21	20	200	25	6	●	2		
325-W25-06	3	25	25	100	30	6	●	1		
325-25-06-L120	3	25	25	120	30	6	●	2		
325-25-06-L200	3	25	25	200	30	6	●	2		
326-25-06-L200	3	26	25	200	30	6	●	2		
425-W25-06	4	25	25	100	30	6	●	1		
425-25-06-L120	4	25	25	120	30	6	●	2		
432-W32-06	4	32	32	110	35	6	●	1		
432-32-06-L130	4	32	32	130	35	6	●	2		
432-32-06-L210	4	32	32	210	35	6	●	2		
433-32-06-L220	4	33	32	220	35	6	●	2		
532-W32-06	5	32	32	110	35	6	●	1		
532-32-06-L130	5	32	32	130	35	6	●	2		
540-W32-06	5	40	32	110	40	6	●	1		
540-32-06-L150	5	40	32	150	40	6	●	2		
540-32-06-L250	5	40	32	250	40	6	●	2		
640-W32-06	6	40	32	110	35	6	●	1		
640-32-06-L150	6	40	32	150	35	6	●	2		

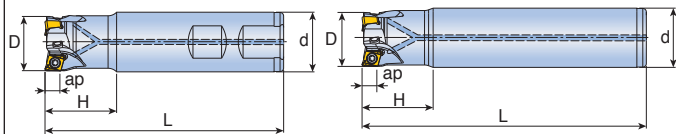
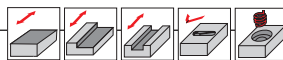

- Параметры ap и L относятся к пластинам с радиусом 08R
- Корпус фрезы для пластины '4NKT 06' с радиусом при вершине более 1,6 мм должен быть доработан по формуле: Радиус корпуса = Радиус пластины - 0,2 мм

4N TE90...-M...-06

Модульная головка

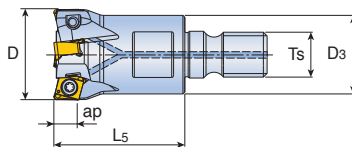
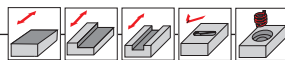

Обозначение		Размеры (мм)					Каналы СОЖ	Пластина
		D	Dз	L5	Ts	ap		
4N TE90-216-M08-06	2	16	13	23	8	6	●	4NKT 0603... E195
217-M08-06	2	17	13	23	8	6	●	
220-M10-06	2	20	18	35	10	6	●	
320-M10-06	3	20	18	35	10	6	●	
321-M10-06	3	21	18	35	10	6	●	
325-M12-06	3	25	21	35	12	6	●	
425-M12-06	4	25	21	35	12	6	●	
426-M12-06	4	26	21	35	12	6	●	
432-M16-06	4	32	29	43	16	6	●	
532-M16-06	5	32	29	43	16	6	●	
533-M16-06	5	33	29	43	16	6	●	
535-M16-06	5	35	29	43	16	6	●	
540-M16-06	5	40	29	43	16	6	●	
640-M16-06	6	40	29	43	16	6	●	

- Параметры ap и L относятся к пластинам с радиусом 08R • устанавливается на хвостовик T-FLEXTEC: см. раздел G
- Корпус фрезы для пластины '4NKT 06' с радиусом при вершине более 1,6 мм должен быть доработан по формуле: Радиус корпуса = Радиус пластины - 0,2 мм

Запчасти

Обозначение	Винт	Ключ			
4N TE90-06	TS 30B068//HG	TD 8			



TE90XEV-HSK63A-16

CHASEALU

Концевые фрезы под патроны HSK

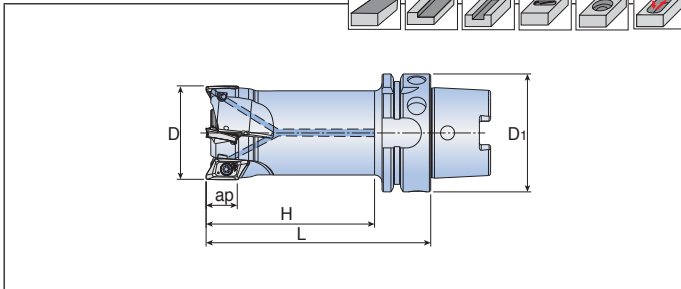
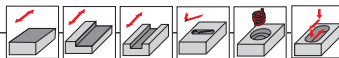

Обозначение	⊕	Размеры (мм)					Каналы СОЖ	Макс. RPM	Пластина
		D	D1	L	H	ap			
TE90XEV 225-100-HSK63A-16	2	25	63	100	70	16	●	52,000	XEVT 1605... E236
232-125-HSK63A-16	2	32	63	125	95	16	●	46,000	
332-90-HSK63A-16	3	32	63	90	60	16	●	46,000	
340-105-HSK63A-16	3	40	63	105	75	16	●	41,200	
450-105-HSK63A-16	4	50	63	105	75	16	●	36,800	
450-120-HSK63A-16	4	50	63	120	90	16	●	36,800	

• Корпус фрезы для пластины 3.2 мм (XEVT 16), 3.0mm (XEVT 22) должен быть изменён по формуле:
 Радиус корпуса = Радиус пластины - 0,3 мм

Запчасти

Обозначение	Винт	Ключ			
TE90XEV-16 (-Ø25)	TS 40085I/HG	T-T15			
TE90XEV-16 (Ø32-)	TS 40093I/HG	T-T15			

 Режимы резания E241-E243	 Исполнение корпуса E220-E221	 Углы врезания E271-E272
---------------------------------	-------------------------------------	--------------------------------

TE90XEV-16/22

Концевая фреза

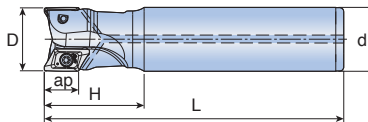
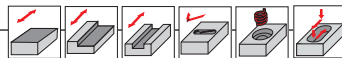

Обозначение	✂	Размеры (мм)					Каналы СОЖ	Макс. RPM	Пластина
		D	d	L	H	ap			
TE90XEV 225-25-16	2	25	25	125	55	16	•	52,000	XEVT 1605...
225-25-16-L170	2	25	25	170	70	16	•	52,000	E236
232-32-16	2	32	32	150	50	16	•	46,000	
232-32-16-L200	2	32	32	200	80	16	•	46,000	
332-32-16	3	32	32	150	50	16	•	46,000	
332-32-16-L200	3	32	32	200	80	16	•	46,000	
340-32-16	3	40	32	170	55	16	•	41,200	
340-32-16-L250	3	40	32	250	55	16	•	41,200	
TE90XEV 232-32-22	2	32	32	160	100	21	•	37,500	XEVT 2206...
340-40-22	3	40	40	160	80	21	•	35,100	E236



TE90XEV...-M...-16

Модульная головка

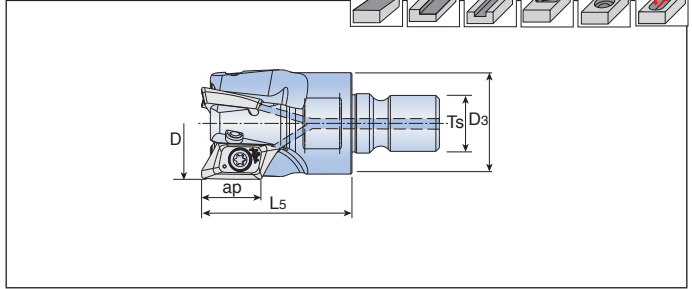
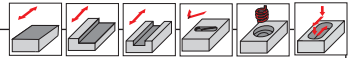

Обозначение		Размеры (мм)					Каналы СОЖ	Макс. RPM	Пластина
		D	D3	L5	Ts	ap			
TE90XEV 225-M12-16	2	25	21	43	12	16	●	52,000	XEVT 1605... E236
232-M16-16	2	32	29	43	16	16	●	46,000	
332-M16-16	3	32	29	43	16	16	●	46,000	
340-M16-16	3	40	29	43	16	16	●	41,200	

- устанавливается на хвостовик T-FLEXTEC: см. раздел G
- Корпус фрезы для пластины 3.2 мм (XEVT 16), 3.0mm (XEVT 22) должен быть изменён по формуле:
Радиус корпуса = Радиус пластины - 0,3 мм

Запчасти

Обозначение	Винт	Ключ			
TE90XEV-16 (-Ø25)	TS 40085I/HG	T-T 15			
TE90XEV-16 (Ø32-)	TS 40093I/HG	T-T 15			
TE90XEV-22 (-Ø32)	TS 50105I	T-T 20			
TE90XEV-22 (Ø40-)	TS 50115I	T-T 20			

Режимы резания E241-E243
 Углы врезания E271-E272

Концевая фреза

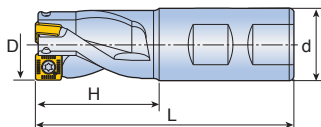
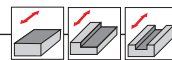

Обозначение		Размеры (мм)				Глубина Ap	Пластина
		D	d	L	H		
TSF 112-W16-06	1	12	16	80	27	5.6	XOMET 0602...
216-W20-06	2	16	20	90	27	5.6	
320-W20-06	3	20	20	100	25	5.6	
TSF 222-W25-09	2	22	25	100	40	9.0	SPMG(T) 0904...
225-W25-09	2	25	25	100	40	9.0	
TSF 332-W32-11	3	32	32	115	55	10.7	SPMG(T) 1104...
440-W32-11	4	40	32	125	55	10.7	
TSF 445-W32-14	4	45	32	130	70	13.4	SPMG(T) 1405...
450-W32-14	4	50	32	140	80	13.4	

Запчасти

Обозначение	Винт	Ключ			
TSF (Ø12)	TS 22046I	TD7			
TSF (Ø16-Ø20)	TS 22052I/HG	TD7			
TSF (Ø22-Ø25)	TS 35088I	TD10			
TSF (Ø32-Ø40)	TS 40093I	TD15			
TSF (Ø45-Ø50)	TS 50A121I/HG	TD20			



Концевая фреза

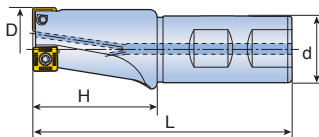
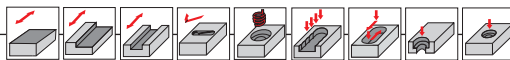
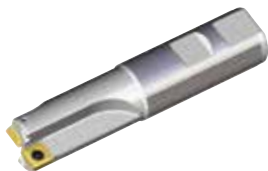

Обозначение		Размеры (мм)				Каналы СОЖ	Максимальная глубина сверления	Глубина Ар	Пластина
		D	d	L	H				
TDM 112 W16-06	1	12	16	80	20	●	12	5.6	XOMET 0602...
216 W20-06	2	16	20	90	25	●	16	5.6	E228
218 W20-06	2	18	20	90	25	●	16	5.6	
220 W25-06	2	20	25	100	40	●	20	5.6	
222 W25-06	2	22	25	110	47	●	25	5.6	
TDM 225 W25-09	2	25	25	110	50	●	30	9.0	SPMG(T) 0904...-EM
228 W32-09	2	28	32	125	60	●	38	9.0	E228
TDM 232 W32-11	2	32	32	125	60	●	38	10.7	SPMG(T) 1104...-EM
240 W32-11	2	40	32	125	60	●	38	10.7	E228
TDM 245 W32-14	2	45	32	130	66	●	40	13.4	SPMG(T) 1405...-EM
250 W32-14	2	50	32	150	66	●	40	13.4	E228

Запчасти

Обозначение	Винт	Ключ			
TDM (Ø12)	TS 22046I	TD7			
TDM (Ø16-Ø20)	TS 22052I/HG	TD7			
TDM (Ø22-Ø25)	TS 35088I	TD10			
TDM (Ø32-Ø40)	TS 40093I	TD15			
TDM (Ø45-Ø50)	TS 50A121I/HG	TD20			



TCF-11

Концевая фреза



Рис.1

Рис.2

Обозначение		Размеры (мм)				Рис.	Область применения (мм)	Пластина
		K	D	D ₁	ap			
TCF 15 D25-11	2	75°	25	30.5	10.1	1	Ø26.3-Ø30.0	SPMT(G) 1104...EM
30 D25-11	2	60°	25	35.5	8.9	1	Ø26.3-Ø34.0	
45 D07-11	1	45°	7	21.5	7.2	2	Ø8.3-Ø20.9	
45 D19-11	2	45°	19	33.4	7.2	1	Ø20.3-Ø32.9	
45 D25-11	3	45°	25	39.4	7.2	1	Ø26.3-Ø38.9	

Запчасти

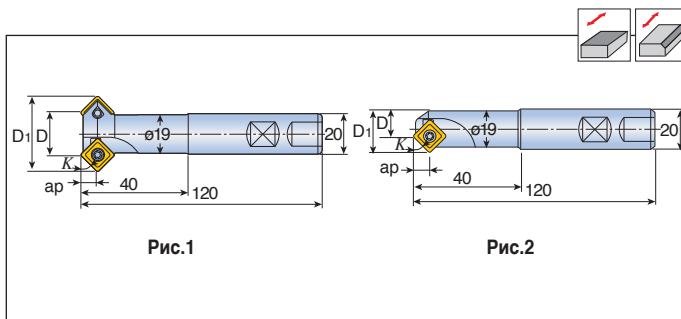
Обозначение	Винт	Ключ			
TCF-11	TS 40093I	TD15			



7S-E45-06

Концевая фреза

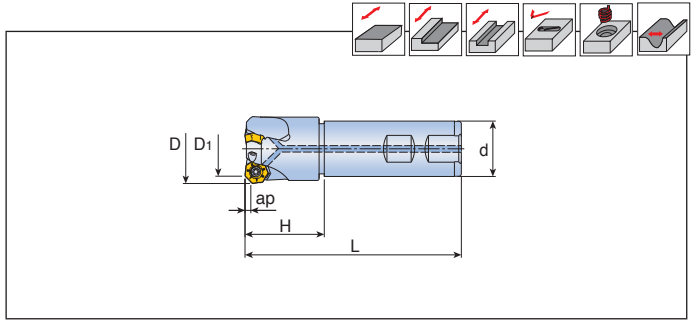

Обозначение		Размеры (мм)						Каналы СОЖ	Пластина
		D	D ₁	d	L	H	ap		
7S-E45 232P-W32-06	2	32	23.7	32	125	45	3.2	●	7EMT 0604 ...
340P-W32-06	3	40	31.6	32	125	45	3.2	●	E198
450P-W32-06	4	50	41.5	32	125	45	3.2	●	

Запчасти

Обозначение	Винт	Ключ			
7S-E45-06 (-Ø40)	TS40085I/HG	TD15			
7S-E45-06 (Ø50-)	TS40093I/HG	TD15			



Концевая фреза

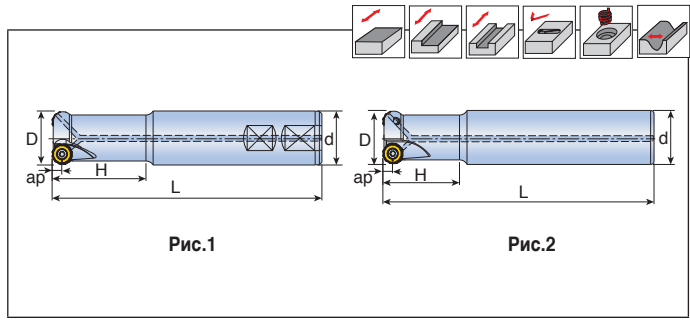

Обозначение		Размеры (мм)					Каналы СОЖ	Рис.	Пластина
		D	d	L	H	ap			
TERNS 225-25-10-L160	2	25	25	160	60	5	●	2	RNMU 1004...
225-32-10-L250	2	25	32	250	40	5	●	2	
325-25-10-L160	3	25	25	160	60	5	●	2	
226-25-10-L200	2	26	25	200	80	5	●	2	
332-32-10-L180	3	32	32	180	70	5	●	2	
332-32-10-L250	3	32	32	250	100	5	●	2	
432-32-10-L180	4	32	32	180	70	5	●	2	
432-32-10-L250	4	32	32	250	100	5	●	2	
433-32-10-L200	4	33	32	200	80	5	●	2	
433-32-10-L250	4	33	32	250	100	5	●	2	
TERNS 232-32-12-L150	2	32	32	150	50	6	●	2	RNMU 1205...
232-32-12-L200	2	32	32	200	60	6	●	2	
232-32-12-L	2	32	32	250	50	6	●	2	
332-W32-12	3	32	32	160	60	6	●	1	
332-32-12-L200	3	32	32	200	70	6	●	2	
332-32-12-L250	3	32	32	250	60	6	●	2	
233-32-12-L200	2	33	32	200	50	6	●	2	
233-32-12-L250	2	33	32	250	60	6	●	2	
333-32-12-L200	3	33	32	200	70	6	●	2	
333-32-12-L250	3	33	32	250	60	6	●	2	
340-W32-12	3	40	32	160	50	6	●	1	
340-32-12-L250	3	40	32	250	50	6	●	2	
440-W32-12	4	40	32	160	50	6	●	1	
440-32-12-L250	4	40	32	250	60	6	●	2	
450-32-12-L200	4	50	32	200	70	6	●	2	
550-32-12-L250	5	50	32	250	60	6	●	2	
TERNS 240-32-16-L160	2	40	32	160	50	6	●	1	RNMU 1606...
240-32-16-L180	2	40	32	180	70	8	●	2	
240-32-16-L250	2	40	32	250	100	8	●	2	
340-32-16-L180	3	40	32	180	70	8	●	2	
340-32-16-L250	3	40	32	250	100	8	●	2	



Модульная головка

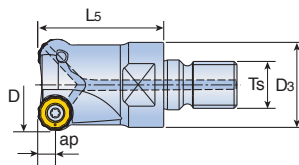
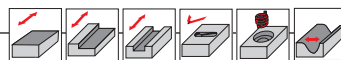

Обозначение		Размеры (мм)					Каналы СОЖ	Пластина
		D	D ₃	L ₅	T _s	ap		
TERNS 225-M12-10	2	25	21	35	12	5	●	RNMU 1004...
325-M12-10	3	25	21	35	12	5	●	
432-M16-10	4	32	29	43	16	5	●	
542-M16-10	5	42	29	43	16	5	●	RNMU 1205...
TERNS 232-M16-12	2	32	29	43	16	6	●	
332-M16-12	3	32	29	43	16	6	●	
233-M16-12	2	33	29	43	16	6	●	
333-M16-12	3	33	29	43	16	6	●	
340-M16-12	3	40	29	43	16	6	●	
440-M16-12	4	40	29	43	16	6	●	RNMU 1606...
TERNS 240-M16-16	2	40	29	43	16	8	●	
340-M16-16	3	40	29	43	16	8	●	

• устанавливается на хвостовик T-FLEXTEC: см. раздел **G**

Запчасти

Обозначение	Винт	Ключ			
TERNS-10	TS 35085I/HG	TD 15			
TERNS-12	TS 40G110I	T-T15			
TERNS-16	TS 50A121I/HG	TD 20			



Концевая фреза

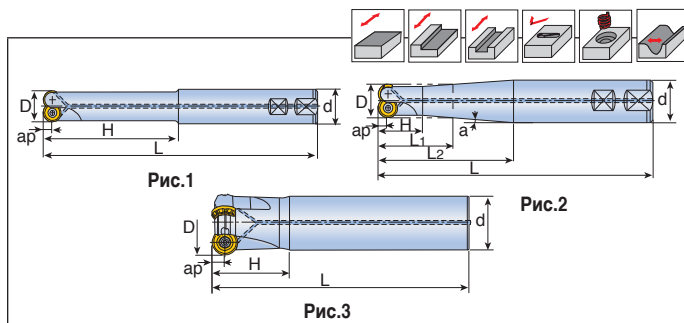

Обозначение	✂	Размеры (мм)								Каналы СОЖ	Рис.	Пластина
		D	d	L	H	L1	L2	a°	ap			
TERD 108-W10-05	1	8	10	80	20	-	-	-	2.5	●	1	RDMX 0501...
210-W12-05	2	10	12	80	30	-	-	-	2.5	●	1	E217
212-W12-05	2	12	12	100	40	-	-	-	2.5	●	1	
212-16-05-L	2	12	16	200	20	34	60	2.0	2.5	●	2	
215-W20-07	2	15	20	140	40	-	-	-	3.5	●	1	RDMX 0702...
215-20-07-L	2	15	20	200	25	34	60	3.5	3.5	●	2	E217
217-16-07-L160	2	17	16	160	25	-	-	-	3.5	●	3	
217-16-07-L200	2	17	16	200	25	-	-	-	3.5	●	3	
TERX 220-W20-10	2	20	20	160	60	-	-	-	5	●	1	RXM(H)X 1003...
220-25-10-L	2	20	25	250	46	60	80	4.0	5	●	2	E217
221-20-10-L160	2	21	20	160	30	-	-	-	5	●	3	
221-20-10-L200	2	21	20	200	30	-	-	-	5	●	3	
225-W25-10	2	25	25	160	60	-	-	-	5	●	1	
225-32-10-L	2	25	32	250	30	50	80	6.8	5	●	2	
226-25-10-L200	2	26	25	200	30	-	-	-	5	●	3	
226-25-10-L250	2	26	25	250	30	-	-	-	5	●	3	
226-25-10-L300	2	26	25	200	30	-	-	-	5	●	3	
325-W25-10	3	25	25	160	60	-	-	-	5	●	1	
432-W32-10	4	32	32	160	60	-	-	-	5	●	1	
TERX 225-W25-12	2	25	25	160	60	-	-	-	6	●	1	RXM(H)X 12T3...
225-W25-12-S-C	2	25	25	100	40	-	-	-	6	●	1	E217
226-25-12-L250	2	26	25	250	40	-	-	-	6	●	3	
232-32-12-L	2	32	32	250	50	-	-	-	6	●	3	
332-W32-12	3	32	32	160	64	-	-	-	6	●	1	
233-32-12-L200	2	33	32	200	40	-	-	-	6	●	3	
233-32-12-L250	2	33	32	250	40	-	-	-	6	●	3	
233-32-12-L300	2	33	32	300	40	-	-	-	6	●	3	
235-32-12-L250	2	35	32	250	40	-	-	-	6	●	3	
340-32-12-L250	3	40	32	250	40	-	-	-	6	●	3	
440-W32-12	4	40	32	160	50	-	-	-	6	●	1	
440-W32-12-S-C	4	40	32	105	35	-	-	-	6	●	1	
TERX 240-W32-16	2	40	32	160	50	-	-	-	8	●	1	RXMX 1604...
340-32-16-L250	3	40	32	250	50	-	-	-	8	●	3	E217
TERX 350-32-20	3	50	32	160	50	-	-	-	10	●	3	RXMX 2006...
350-42-20	3	50	42	200	60	-	-	-	10	●	3	E217

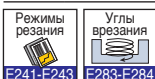

Модульная головка

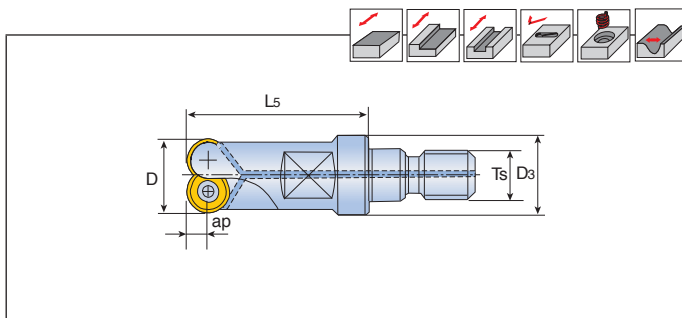

Обозначение		Размеры (мм)					Каналы СОЖ	Пластина
		D	D ₃	L ₅	T _s	ap		
TERD 108-M06-05	1	8	9.7	28	6	2.5	●	RDMX 0501...
210-M06-05	2	10	9.7	28	6	2.5	●	E217
210-M08-05	2	10	13	28	8	2.5	●	
212-M08-05	2	12	13	28	8	2.5	●	
312-M08-05	3	12	13	28	8	2.5	●	
215-M08-07	2	15	13	23	8	3.5	●	RDMX 0702...
220-M08-07	2	20	13	30	8	3.5	●	E217
320-M08-07	3	20	13	30	8	3.5	●	
TERX 220-M10-10	2	20	18	30	10	5.0	●	RXM(H)X 1003...
225-M12-10	2	25	21	35	12	5.0	●	E217
325-M12-10	3	25	21	35	12	5.0	●	
430-M16-10	4	30	29	43	16	5.0	●	
432-M16-10	4	32	29	43	16	5.0	●	
435-M16-10	4	35	29	43	16	5.0	●	
542-M16-10	5	42	29	43	16	5.0	●	
TERX 224-M12-12	2	24	21	35	12	6.0	●	RXM(H)X 12T3...
232-M16-12	2	32	29	43	16	6.0	●	E217
332-M16-12	3	32	29	43	16	6.0	●	
335-M16-12	3	35	29	43	16	6.0	●	
340-M16-12	3	40	29	43	16	6.0	●	
442-M16-12	4	42	29	43	16	6.0	●	
TERX 232-M16-16	2	32	29	43	16	8.0	●	RXXM 1604...
342-M16-16	3	42	29	43	16	8.0	●	E217

• устанавливается на хвостовик T-FLEXTEC: см. раздел **G**

Запчасти

Обозначение	Винт	Ключ			
TERD-05	TS 20038I	TD 6			
TERD-07	SO 25050I	TD 7			
TERX-10	TS 35070I/HG	TD 15			
TERX-12	TS 35085I/HG	TD 15			
TERX-16	TS 45A100I/HG	TD 20			
TERX-20	TS 50115I/HG	TD 20			

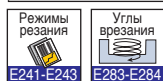

Концевая фреза

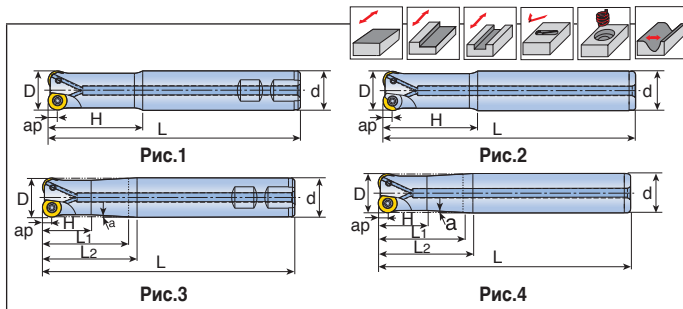

Обозначение	R		Размеры (мм)								Каналы СОЖ	Рис.	Пластина
			D	d	L	H	L1	L2	a°	ap			
TERY 216-W20-08-L	4	2	16	20	110	25	45	55	4.1	4	●	3	RYM(H)X 0803... E218-E219
217-16-08-L130	4	2	17	16	130	30	-	-	-	4	●	2	
218-16-08-L150	4	2	18	16	150	30	-	-	-	4	●	2	
320-W20-08	4	3	20	20	150	43	-	-	-	4	●	1	
320-20-08-L110	4	3	20	20	110	60	-	-	-	4	●	2	
321-20-08-L150	4	3	21	20	150	40	-	-	-	4	●	2	
425-W25-08	4	4	25	25	150	43	-	-	-	4	●	1	
426-25-08-L150	4	4	26	25	150	40	-	-	-	4	●	2	
532-W32-08	4	5	32	32	160	60	-	-	-	4	●	1	
TERY 220-W20-10	5	2	20	20	160	60	-	-	-	5	●	1	
220-25-10-L	5	2	20	25	250	36	60	80	3.5	5	●	4	
221-20-10-L200	5	2	21	20	200	30	-	-	-	5	●	2	
225-32-10-L	5	2	25	32	250	36	53	80	5.0	5	●	4	
225-W25-10	5	2	25	25	160	60	-	-	-	5	●	1	
325-W25-10	5	3	25	25	160	60	-	-	-	5	●	1	
226-25-10-L200	5	2	26	25	200	30	-	-	-	5	●	2	
326-25-10-L200	5	3	26	25	200	60	-	-	-	5	●	2	
432-W32-10	5	4	32	32	160	60	-	-	-	5	●	1	RYM(H)X 1205... E218-E219
TERY 225-W25-12	6	2	25	25	160	60	-	-	-	6	●	1	
226-25-12-L200	6	2	26	25	200	60	-	-	-	6	●	2	
232-32-12-L	6	2	32	32	250	50	-	-	-	6	●	2	
332-W32-12	6	3	32	32	160	64	-	-	-	6	●	1	
332-W32-12-S	6	3	32	32	105	35	-	-	-	6	●	1	
233-32-12-L250	6	2	33	32	250	40	-	-	-	6	●	2	
333-32-12-L200	6	3	33	32	200	60	-	-	-	6	●	2	
340-W32-12	6	3	40	32	160	50	-	-	-	6	●	1	
340-W32-12-S	6	3	40	32	105	35	-	-	-	6	●	1	
340-32-12-L250	6	3	40	32	250	50	-	-	-	6	●	2	
440-W32-12	6	4	40	32	150	35	-	-	-	6	●	1	RYM(H)X 1606... E218-E219
440-W32-12-S	6	4	40	32	105	35	-	-	-	6	●	1	
TERY 240-W32-16	8	2	40	32	160	50	-	-	-	8	●	1	RYM(H)X 2007... E218-E219
340-32-16-L250	8	3	40	32	250	50	-	-	-	8	●	2	
TERY 350-32-20	10	3	50	32	160	50	-	-	-	10	●	2	RYM(H)X 2007... E218-E219
350-40-20	10	3	50	40	200	60	-	-	-	10	●	2	



E241-E243

E285-E287

Модульная головка

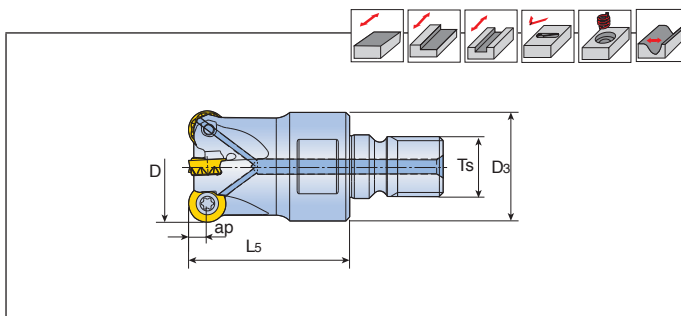

Обозначение	R	⊙	Размеры (мм)					Каналы СОЖ	Пластина
			D	D ₃	L ₅	T _s	ap		
TERY 216-M08-08	4	2	16	13	23	8	4	●	RYM(H)X 0803... E218-E219
218-M08-08	4	2	18	13	23	8	4	●	
220-M10-08	4	2	20	18	30	10	4	●	
320-M10-08	4	3	20	18	30	10	4	●	
425-M12-08	4	4	25	21	35	12	4	●	
530-M16-08	4	5	30	29	43	16	4	●	
532-M16-08	4	5	32	29	43	16	4	●	
540-M16-08	4	5	40	29	43	16	4	●	
640-M16-08	4	6	40	29	43	16	4	●	
TERY 220-M10-10	5	2	20	18	30	10	5	●	RYM(H)X 1004... E218-E219
225-M12-10	5	2	25	21	35	12	5	●	
325-M12-10	5	3	25	21	35	12	5	●	
430-M16-10	5	4	30	29	43	16	5	●	
432-M16-10	5	4	32	29	43	16	5	●	
435-M16-10	5	4	35	29	43	16	5	●	
542-M16-10	5	5	42	29	43	16	5	●	
642-M16-10	5	6	42	29	43	16	5	●	

Режимы резания E241-E243

Углы врезания E285-E287

• устанавливается на хвостовик T-FLEXTEC: см. раздел G

Модульная головка

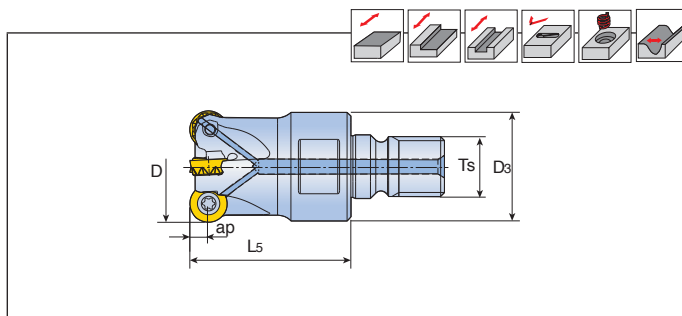

Обозначение	R		Размеры (мм)					Каналы СОЖ	Пластина
			D	Dз	L5	Ts	ap		
TERY 225-M12-12	6	2	25	21	35	12	6	●	RYM(H)X 1205...
232-M16-12	6	2	32	29	43	16	6	●	E218-E219
332-M16-12	6	3	32	29	43	16	6	●	
335-M16-12	6	3	35	29	43	16	6	●	
340-M16-12	6	3	40	29	43	16	6	●	
440-M16-12	6	4	40	29	43	16	6	●	
442-M16-12	6	4	42	29	43	16	6	●	
TERY 232-M16-16	8	2	32	29	43	16	8	●	RYM(H)X 1606...
240-M16-16	8	2	40	29	43	16	8	●	E218-E219
342-M16-16	8	3	42	29	43	16	8	●	

• устанавливается на хвостовик T-FLEXTEC: см. раздел G

Запчасти

Обозначение	Винт	Ключ		
TERY-08	TS 30A060I/HG	TD 9		
TERY-10	TS 35070I/HG(UnderD21), TS 35085I/HG	TD15		
TERY-12	TS 40093I	TD15		
TERY-16	TS 50115I	TD20		
TERY-20	TS 60A130I	SW6-T, BLD T25/M7		

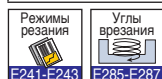

Стальной хвостовик



Рис.1



Рис.2

Обозначение	Размеры (мм)						Каналы СОЖ	Рис.	Пластина
	D	d	L	H	L ₁	α°			
TNF 080-08S	8	8	90	20	-	-	●	1	NFB 080...
080-12S	8	12	100	10	20	9.5°	●	2	NFR 080A...
080-12M	8	12	130	10	50	3°	●	2	
100-10S	10	10	90	30	-	-	●	1	NFB 100...
100-12S	10	12	110	15	25	5°	●	2	NFR 100A...
100-16M	10	16	130	15	60	3.5°	●	2	NFR 110A...
120-12S	12	12	110	30	-	-	●	1	NFB 120...
120-12M	12	12	180	60	-	-	●	1	NFR 120A...
120-16M	12	16	140	25	60	2.4°	●	2	NFR 130A...
120-20L	12	20	180	40	80	5°	●	2	
160-16M	16	16	130	40	-	-	●	1	NFB 160...
160-16L	16	16	200	100	-	-	●	1	NFR 160A...
160-20M	16	20	160	25	60	2.5°	●	2	NFR 170A...
160-25L	16	25	220	55	100	5°	●	2	
200-20S	20	20	110	40	-	-	●	1	NFB 200...
200-20M	20	20	150	50	-	-	●	1	NFR 200A...
200-20L	20	20	220	70	-	-	●	1	NFR 210A...
200-25M	20	25	180	40	80	2.5°	●	2	
200-25L	20	25	220	45	110	1.5°	●	2	
250-25S	25	25	125	40	-	-	●	1	NFB 250...
250-25M	25	25	170	70	-	-	●	1	NFR 250A...
250-32M	25	32	200	32	90	3°	●	2	NFR 260A...
250-32L	25	32	250	40	130	1.5°	●	2	
300-32S	30	32	140	55	-	-	●	1	NFB 300...
300-32M	30	32	190	75	-	-	●	1	NFB 320...
300-32L	30	32	250	65	100	1°	●	2	NFR 300A...
300-32XL	30	32	300	150	-	-	●	1	NFR 320A...
300-32-L220	30	32	220	55	100	1°	●	2	
320-32L	32	32	250	60	-	-	●	1	NFB 320...
									NFR 320A...
									E211-E213

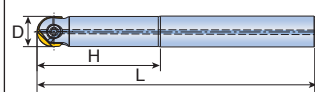
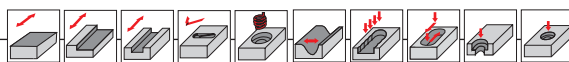

TNF...-CT-L...

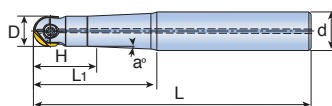
FINEBALL

Твердосплавный хвостовик

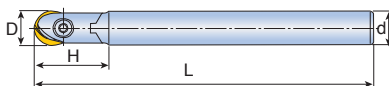
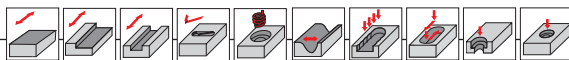

Обозначение	Размеры (мм)				Пластина
	D	d	L	H	
TNF 080-08-CT-L100	8	8	100	30	NFB 080... NFR 080A...
080-10-CT-L140	8	10	140	75	
080-08-CT-L160	8	8	160	80	
100-10-CT-L100	10	10	100	35	NFB 100... NFR 100A... NFR 110A...
100-10-CT-L140	10	10	140	75	
100-10-CT-L200	10	10	200	70	
100-10-CT-L220	10	10	220	140	
120-12-CT-L120	12	12	120	50	NFB 120... NFR 120A... NFR 130A...
120-12-CT-L160-S	12	12	160	70	
120-12-CT-L160	12	12	160	90	
120-12-CT-L200	12	12	200	70	
120-12-CT-L220	12	12	220	150	
160-16-CT-L120	16	16	120	60	NFB 160... NFR 160A... NFR 170A...
160-16-CT-L160-S	16	16	160	60	
160-16-CT-L160	16	16	160	80	
160-16-CT-L200	16	16	200	70	
160-16-CT-L220	16	16	220	150	
200-20-CT-L200	20	20	200	70	NFB 200... NFR 200A... NFR 210A...
250-25-CT-L220-S	25	25	220	80	
200-20-CT-L110	20	20	110	40	
200-20-CT-L220	20	20	220	120	
200-20-CT-L300	20	20	300	220	
250-25-CT-L200	25	25	200	70	NFB 250... NFR 250A... NFR 260A...
250-25-CT-L220	25	25	220	120	
250-25-CT-L300	25	25	300	220	
300-32-CT-L200	30	32	200	70	NFB 300... NFB 320... NFR 300A... NFR 320A...
300-32-CT-L250-S	30	32	250	80	
300-32-CT-L250	30	32	250	150	
300-32-CT-L350-S	30	32	350	80	
300-32-CT-L350	30	32	350	230	
320-32-CT-L300	32	32	300	220	NFB 320... NFR 320A...
					E211-E213



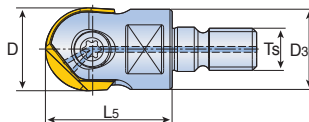
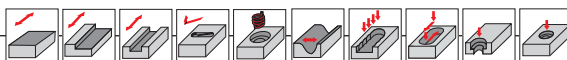

Модульная головка



Обозначение	Размеры (мм)				Каналы СОЖ	Пластина
	D	Dз	L5	Ts		
TNF 100-M06	10	9.7	20	6	●	NFB 100... NFR 100A... NFR 110A...
120-M06	12	11.5	23	6	●	NFB 120...
120-M08	12	13	23	8	●	NFR 120A... NFR 130A...
160-M08	16	13	30	8	●	NFB 160... NFR 160A... NFR 170A...
200-M10	20	19	30	10	●	NFB 200... NFR 200A... NFR 210A...
250-M12	25	24	35	12	●	NFB 250...
250-M16	25	29	43	16	●	NFR 250A... NFR 260A...
300-M16	30	29	43	16	●	NFB 300... NFB 320... NFR 300A... NFR 320A...
320-M16	32	29.5	43	16	●	NFB 320... NFR 320A...
						 E211-E213

• устанавливается на хвостовик T-FLEXTEC: см. раздел G

Запчасти

Обозначение	Винт	Ключ			
					
TNF 080	TS 25F080A	TD 8			
TNF 100	TS 30F100A	TD 10			
TNF 120	TS 40F120A	TD 15			
TNF 160	TS 50F160A	T-T20			
TNF 200	TS 60F200A	SW6-T, BLD T25/M7			
TNF 250	TS 70F250A	SW6-T, BLD T25/M7			
TNF 300, TNF 320	TS 80F300A	T-T30			



Стальной хвостовик



Рис.1

Рис.2

Обозначение	Размеры (мм)						Каналы СОЖ	Рис.	Пластина
	D	d	L	H	L ₁	α°			
TNFR 080-12S	8	12	100	10	22	9°	●	2	NFR 080A...
080-12M	8	12	130	10	50	2.8°	●	2	
100-12S	10	12	110	15	25	5°	●	2	NFR 100A...
100-16M	10	16	150	15	50	3.5°	●	2	NFR 110A...
120-12S	12	12	110	30	-	-	●	1	NFR 120A...
120-16M	12	16	160	18	60	2.5°	●	2	NFR 130A...
160-16S	16	16	130	50	-	-	●	1	NFR 160A...
160-16M	16	16	170	70	-	-	●	1	NFR 170A...
160-16L	16	16	200	100	-	-	●	1	
200-20S	20	20	140	60	-	-	●	1	NFR 200A...
200-20M	20	20	180	80	-	-	●	1	NFR 210A...
200-20L	20	20	250	120	-	-	●	1	
250-25S	25	25	150	70	-	-	●	1	NFR 250A...
250-25M	25	25	200	100	-	-	●	1	NFR 260A...
250-25L	25	25	250	120	-	-	●	1	
300-32S	30	32	140	55	-	-	●	1	NFR 300A
300-32M	30	32	190	75	-	-	●	1	NFR 320A
300-32L	30	32	250	65	100	1	●	2	
320-32L	32	32	250	60	-	-	●	1	NFR 320A
									E212-E213

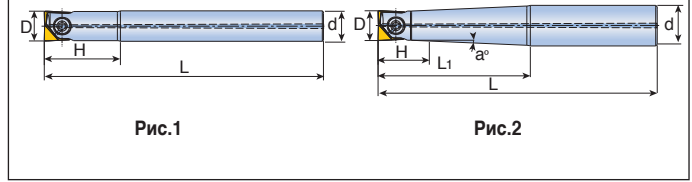
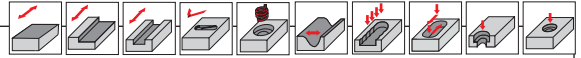

TNFR...-CT-...

FINEBALL

Твердосплавный хвостовик

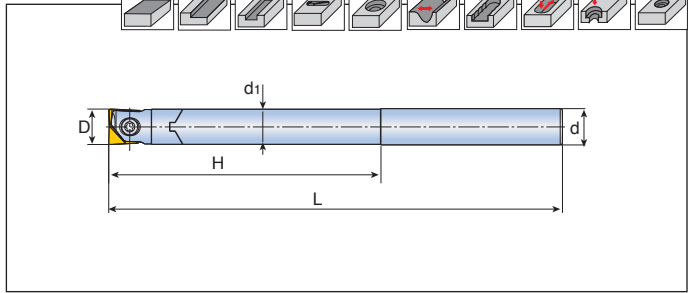
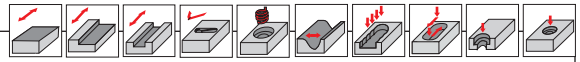

Обозначение	Размеры (мм)					Пластина
	D	d	d1	L	H	
TNFR 080-08-CT-L140	8	8	7.8	140	75	NFR 080A...
100-10-CT-L140	10	10	9.5	140	75	NFR 100A... NFR 110A...
120-12-CT-L160	12	12	11.5	160	95	NFR 120A... NFR 130A...
160-16-CT-L200	16	16	15.5	200	120	NFR 160A... NFR 170A...
200-20-CT-L250	20	20	19.5	250	160	NFR 200A... NFR 210A...
250-25-CT-L300	25	25	24.5	300	200	NFR 250A... NFR 260A...
300-32-CT-L350	30	32	29.5	350	230	NFR 300A NFR 320A
320-32-CT-L350	32	32	31.5	350	230	NFR 320A E212-E213



E241-E243

Модульная головка

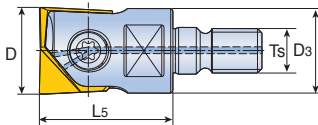
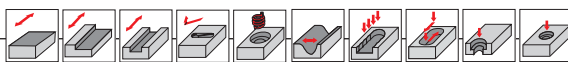

Обозначение	Размеры (мм)				Каналы СОЖ	Пластина
	D	Dз	L5	Ts		
TNFR 100-M06	10	9.7	20	6	●	NFR 100A... NFR 110A...
120-M06	12	11.5	23	6	●	NFR 120A...
120-M08	12	13	23	8	●	NFR 130A...
160-M08	16	13	30	8	●	NFR 160A... NFR 170A...
200-M10	20	19	30	10	●	NFR 200A... NFR 210A...
250-M12	25	24	35	12	●	NFR 250A... NFR 260A...
300-M16	30	29	43	16	●	NFR 300A NFR 320A
320-M16	32	29.5	43	16	●	NFR 320A E212-E213

• устанавливается на хвостовик T-FLEXTEC: см. раздел **G**

Запчасти

Обозначение	Винт	Ключ			
TNFR 080	TS 25F080A	TD 8			
TNFR 100	TS 30F100A	TD 10			
TNFR 120	TS 40F120A	TD 15			
TNFR 160	TS 50F160A	T-T20			
TNFR 200	TS 60F200A	SW6-T, BLD T25/M7			
TNFR 250	TS 70F250A	SW6-T, BLD T25/M7			
TNFR 300, TNFR 320	TS 80F300A	T-T30			



Концевая фреза

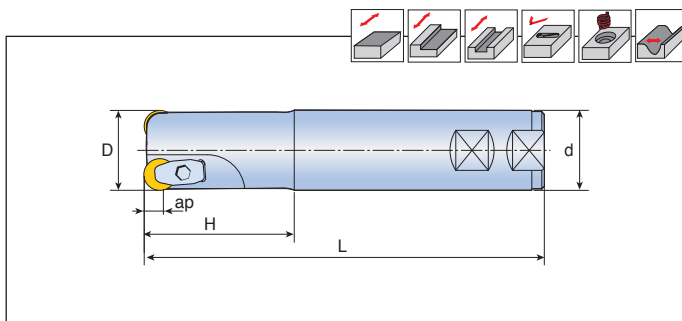

Обозначение		Размеры (мм)					Пластина
		D	d	L	H	ap	
TERP 232-W32-12CH	2	32	32	140	75	6	RPGX 1204-CH
340-W32-12CH	3	40	32	140	40	6	E216

Запчасти

Обозначение	Прижим	Винт	Скрепление	Ключ	
TERP-12CH	CCL-5S	CLS 3C-L15	CSR 2	T-W 3	



Концевая фреза

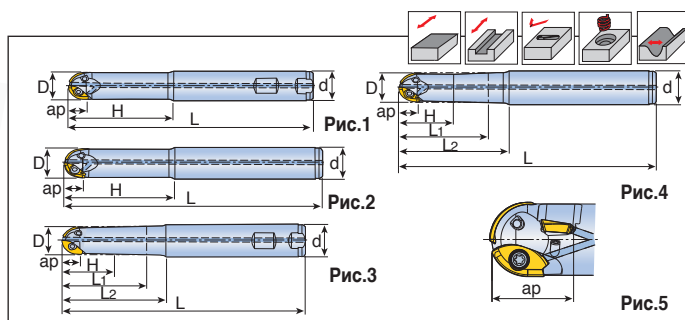

Обозначение	Размеры (мм)							Каналы СОЖ	Рис.	Пластина			
	D	d	L	H	L ₁	L ₂	ap			Сферическая	Периферийная		
2F 16-11-W20-L120	16	20	120	27	35.5	60	11.8	●	3	2FB160-M	2	-	-
16-11-20-L130	16	20	130	35	45.9	60	11.8	●	4		2	-	-
16-11-20-L200	16	20	200	35	45.9	60	11.8	●	4		2	-	-
16-20-W20-L120-P	16	20	120	35	41.8	60	20.5	●	5		2	APKT 09T3	1
16-20-25-L200-P	16	25	200	40	43.4	65	20.5	●	5		2		1
20-13-W25-L105	20	25	105	45	-	-	13.6	●	1	2FB200-M	2	-	-
20-13-W25-L150	20	25	150	40	45.7	65	13.6	●	3		2	-	-
20-13-20-L220	20	20	220	70	-	-	13.6	●	2		2	-	-
20-13-25-L160	20	25	160	45	54.5	75	13.6	●	4		2	-	-
20-13-25-L220	20	25	220	60	65.7	85	13.6	●	4		2	-	-
20-22-25-L125-P	20	25	125	40	45.7	65	22.3	●	5	2FB250-M	2	APKT 09T3	1
20-22-25-L200-P	20	25	200	70	74.3	90	22.3	●	5		2		1
20-22-32-L250-P	20	32	250	70	72.3	100	22.3	●	5		2		1
25-17-W25-L150	25	25	150	60	-	-	17.7	●	1		2	-	-
25-17-32-L150	25	32	150	50	55.7	75	17.7	●	4		2	-	-
25-17-32-L200	25	32	200	55	61.6	85	17.7	●	4	2FB300-M	2	-	-
25-17-32-L300	25	32	300	70	80	120	17.7	●	4		2	-	-
25-35-25-L200-P	25	25	200	87.5	-	-	35.1	●	5		2	APKT 09T3	2
25-35-32-L200-P	25	32	200	100	-	-	35.1	●	5		2		2
25-35-32-L250-P	25	32	250	110	-	-	35.1	●	5		2		⊙ E200
25-43-32-L300-P	25	32	300	120	-	-	43.7	●	5	2		3	
30-20-W32-L180	30	32	180	86.1	-	-	20.0	●	1	2FB300-M	2	-	-
30-20-30-L250	30	30	250	104.6	-	-	20.0	●	2		2	-	-
30-20-32-L200	30	32	200	86.1	-	-	20.0	●	2		2	-	-
30-20-32-L300	30	32	300	126.1	-	-	20.0	●	2		2	-	-
30-43-32-L160-P	30	32	160	66	-	-	43.7	●	5		2	APKT 1204	2
30-43-32-L200-P	30	32	200	85.6	-	-	43.7	●	5	2	2		
30-43-32-L250-P	30	32	250	125.6	-	-	43.7	●	5	2	2		
30-51-32-L300-P	30	32	300	145.6	-	-	55.3	●	5	2		3	
32-21-W32-L200	32	32	200	100	-	-	21.4	●	1	2FB320-M	2	-	-
32-21-32-L180	32	32	180	100	-	-	21.4	●	2		2	-	-
32-21-32-L300	32	32	300	130	-	-	21.4	●	2		2	-	-
32-44-32-L160-P	32	32	160	66.4	-	-	44.7	●	5		⊙ E192	2	2
32-44-32-L200-P	32	32	200	83.7	-	-	44.7	●	5		2	APKT 1204	2
32-44-32-L250-P	32	32	250	123.7	-	-	44.7	●	5	2	⊙ E202	2	
32-44-32-L300-P	32	32	300	143.7	-	-	44.7	●	5	2		2	



Модульная головка

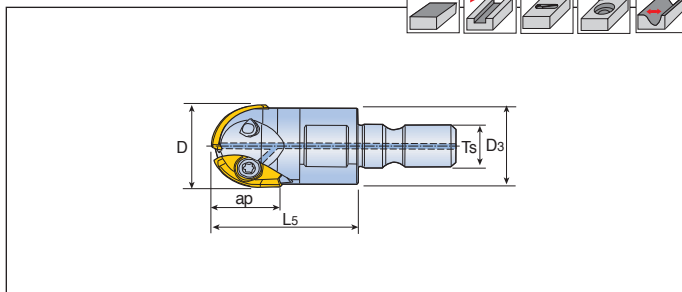
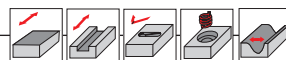

Обозначение		Размеры (мм)					Каналы СОЖ	Пластина
		D	D3	L5	Ts	ap		
2F 16-11-M08	2	16	13	25	8	11.8	●	2FB160-M
20-13-M10	2	20	18	30	10	13.6	●	2FB200-M
25-17-M12	2	25	21	35	12	17.7	●	2FB250-M
30-20-M16	2	30	29	43	16	20.0	●	2FB300-M
32-21-M16	2	32	29	43	16	21.4	●	2FB320-M

• устанавливается на хвостовик T-FLEXTEC: см. раздел G

Запчасти

Обозначение	Винт		Ключ	
	Ball	Periphery	Ball	Periphery
	2FB160-M/АПКТ 09Т3	TS 25064I	TS 25055I/HG	TD 8
2FB200-M/АПКТ 09Т3	TS 30085I/HG	TS 25055I/HG	TD 9	TD 8
2FB250-M/АПКТ 09Т3	TS 35085I/HG	TS 25055I/HG	TD 15	TD 8
2FB300-M/АПКТ 1204	TS 40A100I	TS 35A088I/HG	TD 15	TD 10P
2FB320-M/АПКТ 1204	TS 40A115I	TS 35A088I/HG	TD 15	TD 10P



Концевая фреза

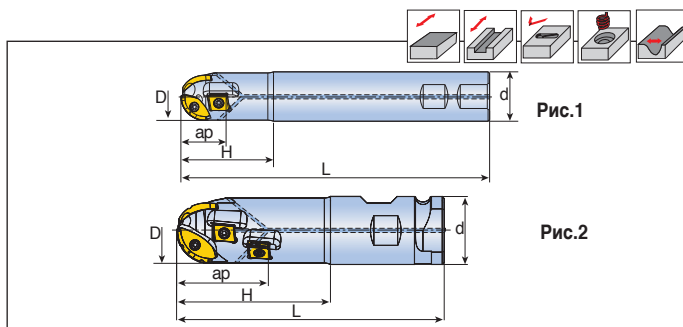

Обозначение	Размеры (мм)					Каналы СОЖ	Fig.	Пластина					
	D	d	L	H	ap			Сферическая1	Сферическая2	Периферийная			
3F 32-39-W32-150	32	32	150	60	39	•	1	3FB320C-M	1	3FB320P-M	2	CNHX 131108T	2
32-39-W32-200	32	32	200	60	39	•	1	3FB320C-M	1	3FB320P-M	2	CNHX 131108T	2
32-39-W32-250	32	32	250	60	39	•	1	3FB320C-M	1	3FB320P-M	2	CNHX 131108T	2
50-54-W40-150	50	40	150	70	54	•	1	3FB500C-M	1	3FB500P-M	2	CNHX 160608T	2
50-80-W50-200	50	50	200	110	80	•	1	3FB500C-M	1	3FB500P-M	2	CNHX 160608T	4
50-80-W50-250	50	50	250	110	80	•	1	3FB500C-M	1	3FB500P-M	2	CNHX 160608T	4
3F 50-68-CN50.8-200	50	50.8	200	115	68	•	2	3FB500C-M	1	3FB500P-M	2	CNHX 160608T	3
50-94-CN50.8-250	50	50.8	250	165	94	•	2	3FB500C-M	1	3FB500P-M	2	CNHX 160608T	5
								E193		E193		E208	

• Когда глубина резания приближена к макс. 'ap', пожалуйста, считайте Z=1

Запчасти

Обозначение	Винт	Ключ			
3F 32	TS 40093I	TD 15			
3F 50	TS 50115I	T-T20			



TDB50X-CN/-W



Концевая фреза

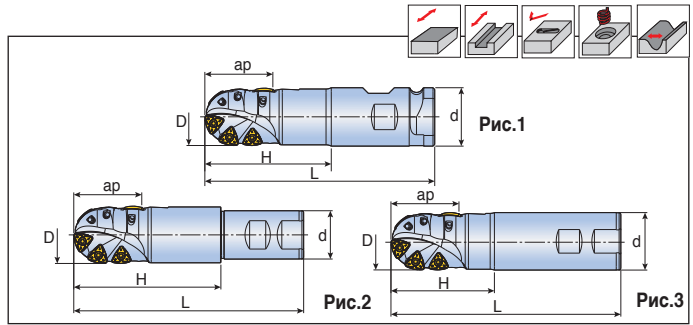

Обозначение	⊙	Размеры (мм)					Рис.	Пластина
		D	d	L	H	ap		
TDB50X 59-CN50.8-L200	6	50	50.8	200	110	59	1	6RBE 50... E197
69-CN50.8-L250	7	50	50.8	250	160	69	1	
TDB50X 59-W40-L200	6	50	40	200	128	59	2	
69-W40-L250	7	50	40	250	178	69	2	
59-W42-L200	6	50	42	200	128	59	2	
69-W42-L250	7	50	42	250	178	69	2	
59-W50-L200	6	50	50	200	90	59	3	
69-W50-L250	7	50	50	250	140	69	3	

Запчасти

Обозначение	Винт	Ключ			
	TDB50X	TS50B106I/HG	T-T20		



TDB50X-WT

Концевая фреза

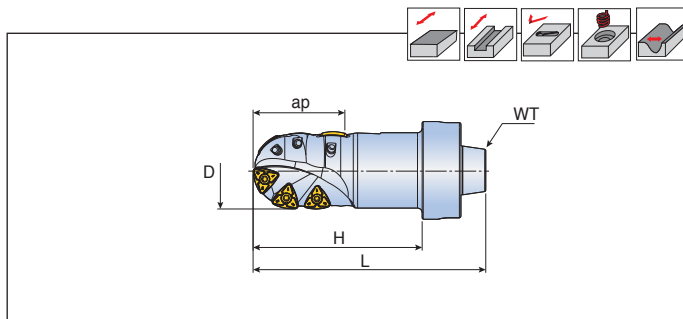

Обозначение	⌀	Размеры (мм)					Пластина
		D	L	WT	H	ap	
TDB50X 59-WT30-L150	6	50	150	30	109	59	6RBE 50...
69-WT30-L200	7	50	200	30	159	69	E197

Запчасти

Обозначение	Винт	Ключ			
TDB50X-WT	TS50B106I/HG	T-T20			



Концевая фреза

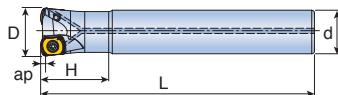
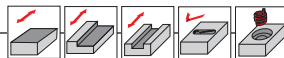

Обозначение		Размеры (мм)					Каналы СОЖ	Пластина
		D	d	L	H	ap		
TEBL 216-15-06-L150	2	16	15	150	40	0.7	●	BLMP 0603... E206
216-16-06	2	16	16	150	40	0.7	●	
216-16-06-S	2	16	16	100	30	0.7	●	
217-16-06-S	2	17	16	100	30	0.7	●	
217-16-06	2	17	16	150	40	0.7	●	
217-16-06-L200	2	17	16	200	20	0.7	●	
218-16-06	2	18	16	150	25	0.7	●	
220-20-06-L200	2	20	20	200	80	1.0	●	
320-19-06-L180	3	20	19	180	80	1.0	●	
320-20-06-S	3	20	20	130	50	1.0	●	
320-20-06	3	20	20	160	80	1.0	●	
321-20-06-S	3	21	20	150	20	1.0	●	
321-20-06-L200	3	21	20	200	20	1.0	●	
325-25-06-L220	3	25	25	220	50	1.0	●	
425-24-06-L180	4	25	24	180	60	1.0	●	
425-25-06-S	4	25	25	140	60	1.0	●	
425-25-06	4	25	25	180	60	1.0	●	
425-25-06-L250	4	25	25	250	40	1.0	●	
326-25-06-L200	3	26	25	200	30	1.0	●	
326-25-06-L250	3	26	25	250	30	1.0	●	
426-25-06-S	4	26	25	150	30	1.0	●	
426-25-06-L200	4	26	25	200	30	1.0	●	
426-25-06-L250	4	26	25	250	30	1.0	●	
530-32-06-S	5	30	32	150	70	1.0	●	
530-32-06-L200	5	30	32	200	120	1.0	●	
432-32-06-S	4	32	32	150	70	1.0	●	
532-32-06-S	5	32	32	150	70	1.0	●	
532-32-06-L200	5	32	32	200	120	1.0	●	
433-32-06-L220	4	33	32	220	40	1.0	●	
433-32-06-L300	4	33	32	300	50	1.0	●	
533-32-06-S	5	33	32	150	30	1.0	●	
533-32-06-L200	5	33	32	200	40	1.0	●	
533-32-06-L250	5	33	32	250	40	1.0	●	
435-32-06-L200	4	35	32	200	50	1.0	●	
435-32-06-L300	4	35	32	300	50	1.0	●	



TEBL-06

Концевая фреза

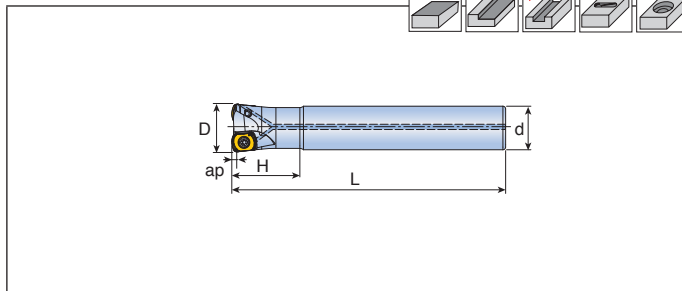
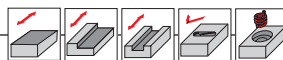

Обозначение		Размеры (мм)					Каналы СОЖ	Пластина
		D	d	L	H	ap		
TEBL 535-32-06-L200	5	35	32	200	50	1.0	●	BLMP 0603... E206
535-32-06-L300	5	35	32	300	50	1.0	●	
540-32-06-L220	5	40	32	220	40	1.0	●	
640-32-06-S	6	40	32	150	40	1.0	●	
640-32-06-L220	6	40	32	220	40	1.0	●	

Запчасти

Обозначение	Винт	Ключ			
	TEBL-06	 TS 25064I/SG	 TD 8P		

 Режимы резания E241-E243	 Углы врезания E277
---------------------------------	---------------------------

Модульная головка

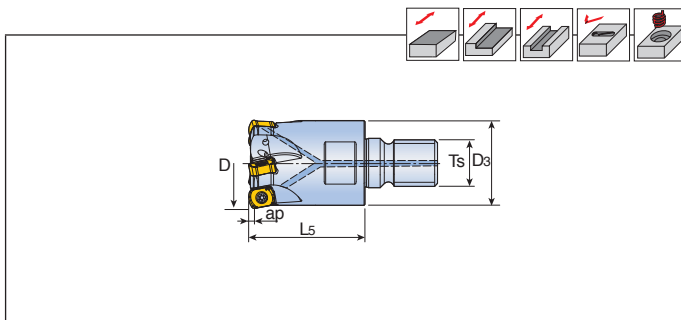

Обозначение		Размеры (мм)					Каналы СОЖ	Пластина
		D	D3	L5	Ts	ap		
TEBL 216-M08-06	2	16	13	25	08	0.7	●	BLMP 0603... E206
217-M08-06	2	17	13	25	08	0.7	●	
218-M08-06	2	18	13	25	08	0.7	●	
220-M10-06	2	20	18	30	10	1.0	●	
320-M10-06	3	20	18	30	10	1.0	●	
321-M10-06	3	21	18	30	10	1.0	●	
322-M10-06	3	22	18	30	10	1.0	●	
325-M12-06	3	25	21	35	12	1.0	●	
425-M12-06	4	25	21	35	12	1.0	●	
326-M12-06	3	26	21	35	12	1.0	●	
426-M12-06	4	26	21	35	12	1.0	●	
530-M16-06	5	30	29	40	16	1.0	●	
432-M16-06	4	32	29	40	16	1.0	●	
532-M16-06	5	32	29	40	16	1.0	●	
433-M16-06	4	33	29	40	16	1.0	●	
533-M16-06	5	33	29	40	16	1.0	●	
435-M16-06	4	35	29	43	16	1.0	●	
535-M16-06	5	35	29	43	16	1.0	●	
640-M16-06	6	40	29	43	16	1.0	●	
542-M16-06	5	42	29	43	16	1.0	●	
642-M16-06	6	42	29	43	16	1.0	●	

• устанавливается на хвостовик T-FLEXTEC: см. раздел **G**

Запчасти

Обозначение	Винт	Ключ			
	TEBL-06	 TS 25064I/SG	 TD 8P		

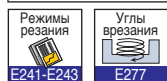

TEBL-09

Концевая фреза

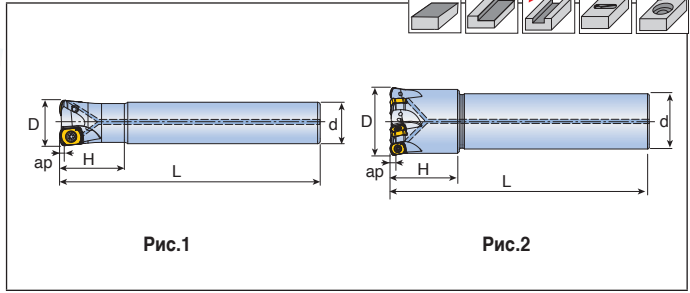
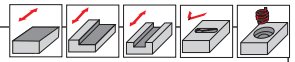

Обозначение	⊕	Размеры (мм)					Каналы СОЖ	Рис.	Пластина
		D	d	L	H	ap			
TEBL 225-25-09-L150	2	25	25	150	70	1.5	●	1	BLMP 0904... E206
225-25-09-L200	2	25	25	200	100	1.5	●	1	
325-25-09-L150	3	25	25	150	70	1.5	●	1	
325-25-09-L200	3	25	25	200	110	1.5	●	1	
326-25-09-L150	3	26	25	150	30	1.5	●	1	
326-25-09-L220	3	26	25	220	30	1.5	●	1	
330-32-09-L160	3	30	32	160	70	1.5	●	1	
330-32-09-L220	3	30	32	220	120	1.5	●	1	
332-32-09-L160	3	32	32	160	70	1.5	●	1	
332-32-09-L220	3	32	32	220	120	1.5	●	1	
432-32-09-L160	4	32	32	160	70	1.5	●	1	
432-32-09-L220	4	32	32	220	120	1.5	●	1	
433-32-09-L180	4	33	32	180	30	1.5	●	1	
433-32-09-L250	4	33	32	250	30	1.5	●	1	
440-32-09-L180	4	40	32	180	40	1.5	●	2	
440-32-09-L250	4	40	32	250	40	1.5	●	2	
540-32-09-L180	5	40	32	180	40	1.5	●	2	
540-32-09-L250	5	40	32	250	40	1.5	●	2	

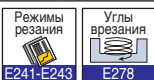

TEBL...-M...-09

Модульная головка

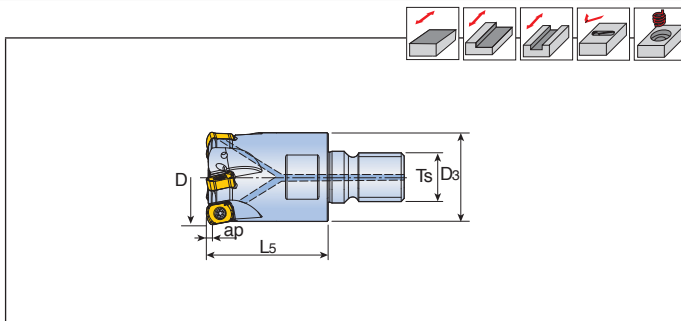

Обозначение		Размеры (мм)					Каналы СОЖ	Пластина
		D	D ₃	L ₅	T _s	ap		
TEBL 225-M12-09	2	25	21	35	12	1.5	●	BLMP 0904... E206
325-M12-09	3	25	21	35	12	1.5	●	
326-M12-09	3	26	21	35	12	1.5	●	
330-M16-09	3	30	29	43	16	1.5	●	
332-M16-09	3	32	29	43	16	1.5	●	
432-M16-09	4	32	29	43	16	1.5	●	
433-M16-09	4	33	29	43	16	1.5	●	
335-M16-09	3	35	29	43	16	1.5	●	
435-M16-09	4	35	29	43	16	1.5	●	
440-M16-09	4	40	29	43	16	1.5	●	
540-M16-09	5	40	29	43	16	1.5	●	
542-M16-09	5	42	29	43	16	1.5	●	

• устанавливается на хвостовик T-FLEXTEC: см. раздел G

Запчасти

Обозначение	Винт	Ключ			
	TEBL-09	TS 35A088/HG	TD 10P		

 Режимы резания E241-E243	 Углы врезания E278
---------------------------------	---------------------------

TEBL-13/TEBL...-M...-13



Концевые фрезы и модульные головки

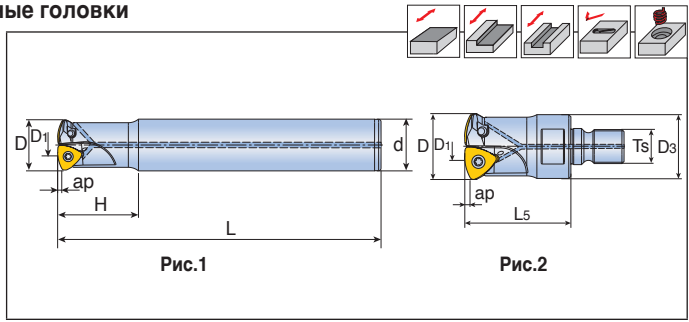
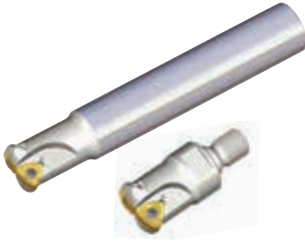

Обозначение		Размеры (мм)									Каналы СОЖ	Рис.	Пластина
		D	D ₁	d	D ₃	L	L ₅	H	T _s	ap			
TEBL 232-32-13-L150	2	32	12.9	32	-	150	-	50	-	2	●	1	BLMP 1306... E207
232-32-13-L200	2	32	12.9	32	-	200	-	80	-	2	●	1	
232-32-13-L	2	32	12.9	32	-	200	-	120	-	2	●	1	
233-32-13-L200	2	33	14.3	32	-	200	-	50	-	2	●	1	
233-32-13-L250	2	33	14.3	32	-	250	-	50	-	2	●	1	
235-32-13-L200	2	35	16.1	32	-	200	-	30	-	2	●	1	
240-42-13-XL	2	40	20.7	42	-	300	-	120	-	2	●	1	
340-32-13-L150	3	40	20.7	32	-	150	-	40	-	2	●	1	
340-32-13-L200	3	40	20.7	32	-	200	-	70	-	2	●	1	
340-42-13-S	3	40	20.7	42	-	150	-	70	-	2	●	1	
TEBL 232-M16-13	2	32	12.9	-	30	-	50	-	16	2	●	2	
233-M16-13	2	33	14.3	-	30	-	50	-	16	2	●	2	
235-M16-13	2	35	16.1	-	30	-	50	-	16	2	●	2	
340-M16-13	3	40	20.7	-	30	-	50	-	16	2	●	2	
342-M16-13	3	42	22.6	-	30	-	50	-	16	2	●	2	

• устанавливается на хвостовик T-FLEXTEC: см. раздел G

Запчасти

Обозначение	Винт	Ключ			
TEBL-13	TS50B106I/HG	T-T20			



TESB-13/TESB ...-M...-13

CHASEFEED

Концевые фрезы и модульные головки

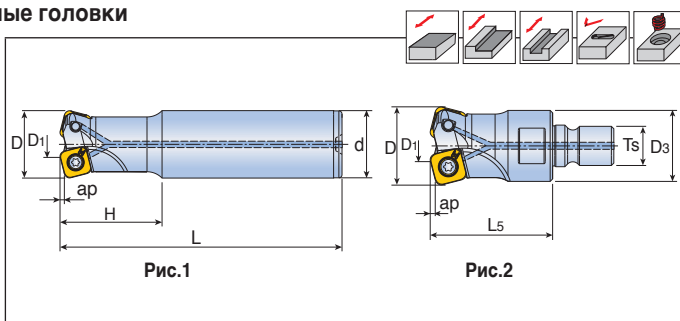

Обозначение		Размеры (мм)									Каналы СОЖ	Рис.	Пластина
		D	D1	d	D3	L	L5	H	Ts	ap			
TESB 232-32-13-L150	2	32	11.6	32	-	150	-	50	-	2	●	1	SBMT 1306... E220
232-32-13-L200	2	32	11.6	32	-	200	-	80	-	2	●	1	
233-32-13-L200	2	33	12.6	32	-	200	-	30	-	2	●	1	
233-32-13-L250	2	33	12.6	32	-	250	-	50	-	2	●	1	
235-32-13-L200	2	35	14.6	32	-	200	-	30	-	2	●	1	
340-32-13-L150	3	40	19.5	32	-	150	-	30	-	2	●	1	
340-32-13-L200	3	40	19.5	32	-	200	-	30	-	2	●	1	
342-32-13-L200	3	42	21.5	32	-	200	-	30	-	2	●	1	
TESB 232-M16-13	2	32	11.6	-	29	-	50	-	16	2	●	2	
233-M16-13	2	33	12.6	-	29	-	50	-	16	2	●	2	
340-M16-13	3	40	19.5	-	29	-	50	-	16	2	●	2	
342-M16-13	3	42	21.5	-	29	-	50	-	16	2	●	2	

• устанавливается на хвостовик T-FLEXTEC: см. раздел G

Запчасти

Обозначение	Винт	Ключ			
	TESB-13	 TS 501151	 T-T20		

Режимы резания

E241-E243

Углы врезания

E280

3P TEF-06

MILL•RUSH

Кукурузная фреза

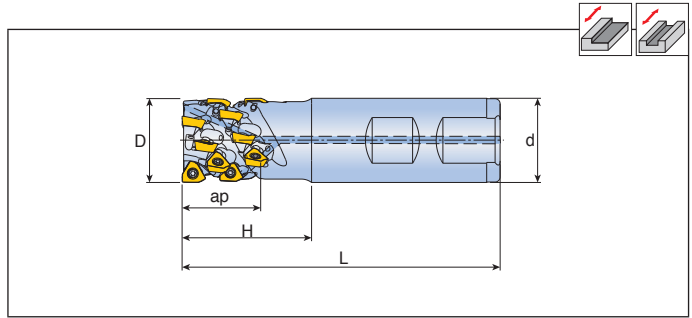

Обозначение		Число пластин	Размеры (мм)					Каналы СОЖ	Пластина
			D	d	L	H	ap		
3P TEF D20-20-W20-06	2	10	20	20	85	33	20	x	3PK(H)T 0603... E194
D25-24-W25-06	3	18	25	25	95	39	24	•	
D32-32-W32-06	4	32	32	32	105	43	32	•	

Запчасти

Обозначение	Винт	Ключ			
3P TEF-06	TS 20043/HG-P	TD6P			



3P TEF/TES-10

MILL-RUSH

Кукурузная фреза

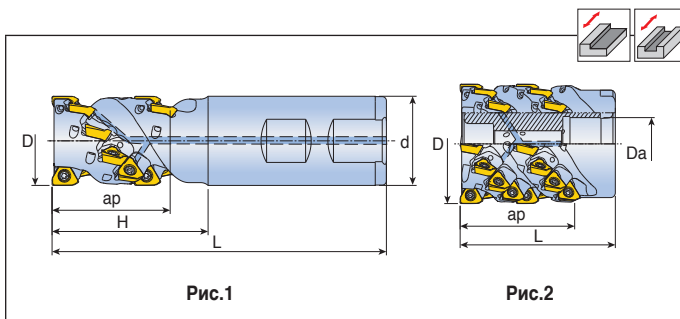

Обозначение	Число пластин	Размеры (мм)						Каналы СОЖ	Kg	Рис.	Крепежный болт	Пластина	
		D	d	Da	L	H	ap						
3P TEF D32-42-W32-10	2	14	32	32	-	120	56	42	●	-	1	-	3PK(H)T 1004...
D40-42-W32-10	3	21	40	32	-	130	56	42	●	-	1	-	E194
3P TES D50-48-22R-10	4	32	50	-	22	65	-	48	●	0.6	2	SH M10x1.5x50	
D63-54-27R-10	4	36	63	-	27	75	-	54	●	1.2	2	SH M12x1.75x50	

Запчасти

Обозначение	Винт	Ключ			
3P TEF/TES-10	TS 25C065/HG	TD8			

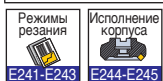

3P TEF/TES-15

MILL-RUSH

Кукурузная фреза

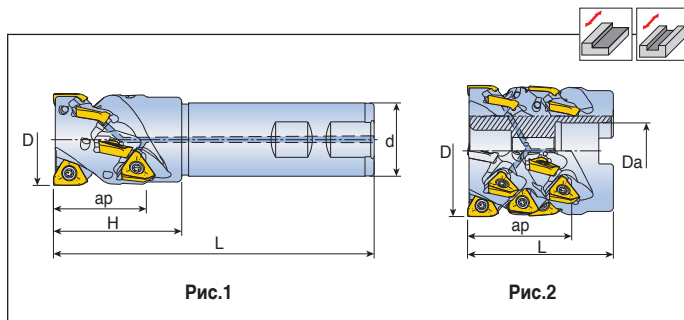

Обозначение	Число пластин	Размеры (мм)						Каналы СОЖ	Кг	Рис.	Крепежный болт	Пластина	
		D	d	Da	L	H	ap						
3P TEF D40-40-W32-15	2	8	40	40	-	140	56	40	●	-	1	-	3PK(H)T 1505...
3P TES D50-40-22R-15-2F	2	8	50	-	22	65	-	40	●	0.6	2	SH M10x1.5x50	E194-E195
D50-40-22R-15	3	12	50	-	22	65	-	40	●	0.6	2	SH M10x1.5x50	
D63-50-27R-15	4	20	63	-	27	70	-	50	●	1.0	2	SH M12x1.75x50	
D80-60-32R-15	4	24	80	-	32	75	-	60	●	2.0	2	SH M16x2x50	
D100-78-40R-15-4F	4	32	100	-	40	110	-	78	●	5.0	2	SH M20x2.5x80	

Запчасти

Обозначение	Винт	Ключ			
3P TEF/TES-15	TS 40B100I	TD15			

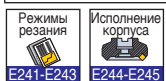

3P TEF/TES-19

MILL-RUSH

Кукурузная фреза

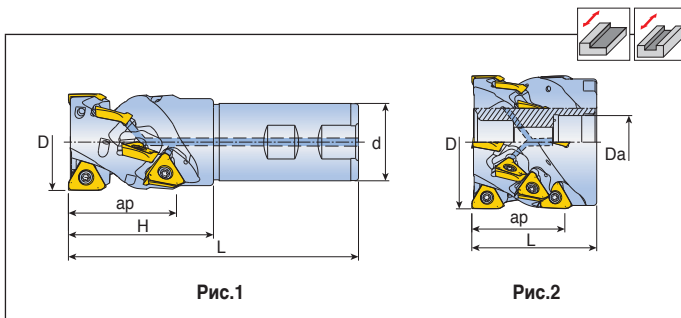

Обозначение	Число пластин	Размеры (мм)							Каналы СОЖ	Рис. кг	Крепежный болт	Пластина	
		D	d	Da	L	H	ap						
3P TEF D50-55-W40-19	2	8	50	40	-	150	75	55	●	-	1	-	3PK(H)T 1906...
3P TES D63-42-27R-19	3	9	63	-	27	70	-	42	●	1.0	2	SH M12x1.75x50	E194-E195
D63-42-27R-19-4F	4	12	63	-	27	70	-	42	●	1.0	2	SH M12x1.75x50	
D80-56-32R-19	4	16	80	-	32	75	-	56	●	1.7	2	SH M16x2x50	
D100-83-40R-19-4F	4	24	100	-	40	110	-	83	●	4.4	2	SH M20x2.5x80	
D100-83-40R-19	5	30	100	-	40	110	-	83	●	4.5	2	SH M20x2.5x80	
D100-83-40R-19-6F	6	36	100	-	40	110	-	83	●	4.6	2	SH M20x2.5x80	

Запчасти

Обозначение	Винт	Ключ			
3P TEF/TES-19	TS 45120I	T-T20			

Режимы резания

E241-E243

Исполнение корпуса

E244-E245

TEF/TES-TN18



Кукурузная фреза



Рис.1

Рис.2

Обозначение		Число пластин	Размеры (мм)						Каналы СОЖ	Кг	Рис.	Крепежный болт	Пластина	
			D	d	Da	L	H	ap						
TEF D50-48-W40-TN18-2F		2	8	50	40	-	140	67	48	●	-	1	-	TNMX 1806...
D50-48-W40-TN18		3	12	50	40	-	140	67	48	●	-	1	-	E233
TES D63-48-27R-TN18-2F		2	8	63	-	27	70	-	48	●	1.2	2	SH M12x1.75x50	
D63-48-27R-TN18		3	12	63	-	27	70	-	48	●	1.1	2	SH M12x1.75x50	
D80-60-32R-TN18		4	20	80	-	32	80	-	60	●	2.2	2	SH M16x2x60	
D100-71-40R-TN18-4F		4	24	100	-	40	100	-	71	●	4.5	2	SH M20x2.5x70	
D100-71-40R-TN18		5	30	100	-	40	100	-	71	●	4.4	2	SH M20x2.5x70	
D100-71-40R-TN18-6F		6	36	100	-	40	100	-	71	●	4.4	2	SH M20x2.5x70	

Запчасти

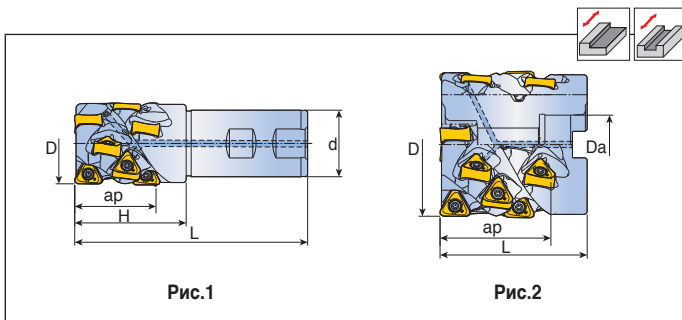
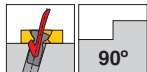
Обозначение	Винт	Ключ			
	TEF/TES-TN18	TS 40B100I	T-T15		



TEF/TES-AN11

Кукурузная фреза

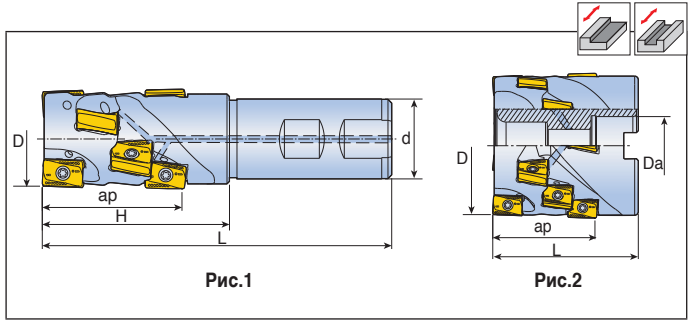

90°

Обозначение		Число пластин	Размеры (мм)						Каналы СОЖ	Kg	Рис.	Крепежный болт	Пластина
			D	d	Da	L	H	ap					
TEF D32-40-W32-AN11	2	8	32	32	-	110	48	40	●	-	1	-	ANM(H)X 1106...
D40-40-W32-AN11	3	12	40	32	-	125	50	40	●	-	1	-	E199
TES D50-40-22R-AN11	3	12	50	-	22	60	-	40	●	0.6	2	SH M10x1.5x40	
D63-60-27R-AN11	4	24	63	-	27	80	-	60	●	1.3	2	SH M12x1.75x60	
D80-60-32R-AN11	5	30	80	-	32	80	-	60	●	2.3	2	SH M16x2x60	

• Крепежный болт с каналом под СОЖ доступен по запросу (Пример заказа: SH M10x1.5x30-C)

Запчасти

Обозначение	Винт	Ключ			
	TEF/TES-AN11	 TS 35A0881/HG	 TD 10P		

Режимы резания

E241-E243

Исполнение корпуса

E244-E245

TEF/TES-AN16

Кукурузная фреза

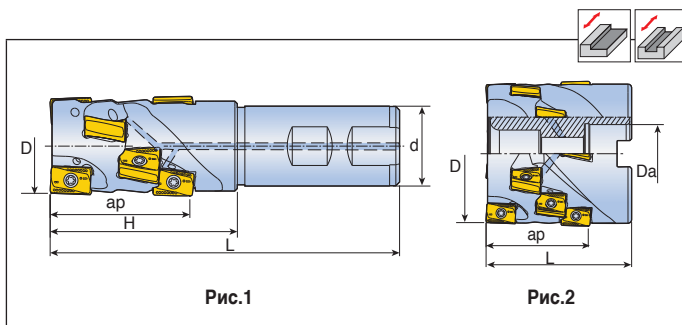

Обозначение	Число пластин	Размеры (мм)						Каналы СОЖ	Kg	Рис.	Крепежный болт	Пластина	
		D	d	Da	L	H	ap						
TEF D40-42-W32-AN16	2	6	40	32	-	120	55	42	•	-	1	-	ANM(H)X 1607... E199
D40-56-W32-AN16	2	8	40	32	-	140	75	56	•	-	1	-	
D50-56-W40-AN16	3	12	50	40	-	140	70	56	•	-	1	-	
TES D50-42-22R-AN16	2	6	50	-	22	65	-	42	•	0.7	2	SH M10x1.5x40	
D63-42-27R-AN16	3	9	63	-	27	70	-	42	•	1.1	2	SH M12x1.75x50	
D63-56-27R-AN16	3	12	63	-	27	80	-	56	•	1.3	2	SH M12x1.75x50	
D80-56-32R-AN16	4	16	80	-	32	80	-	56	•	2.2	2	SH M16x2x50	
D100-69-40R-AN16	5	25	100	-	40	100	-	69	•	4.5	2	SH M20x2.5x60	

• Крепежный болт с каналом под СОЖ доступен по запросу (Пример заказа: SH M10x1.5x30-C)

Запчасти

Обозначение	Винт	Ключ			
TEF/TES-AN16	TS 40120I/HG	T-T15			

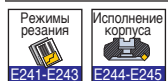

TEF-AX06

CHASEMILL

Кукурузная фреза

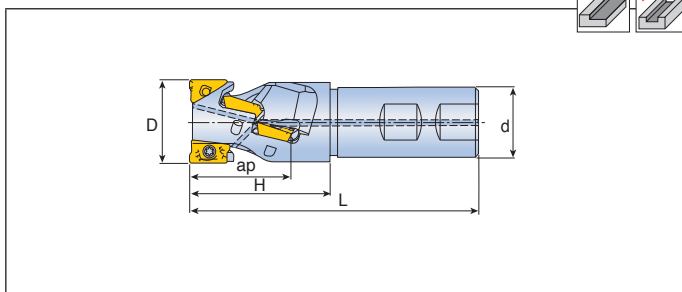

Обозначение	⊕	Число пластин	Размеры (мм)					Каналы СОЖ	Пластина
			D	d	L	H	ap		
TEF D16-16-W16-AX06	2	6	16	16	80	28	16	x	AXM(C)T 0602... E205
D20-21-W20-AX06	3	12	20	20	85	33	21	•	
D25-26-W25-AX06	4	20	25	25	95	38	26	•	

Запчасти

Обозначение	Винт	Ключ			
	TEF-AX06	TS 18041 I/HG	TD6P		



2S-TEF-AP09

Кукурузная фреза

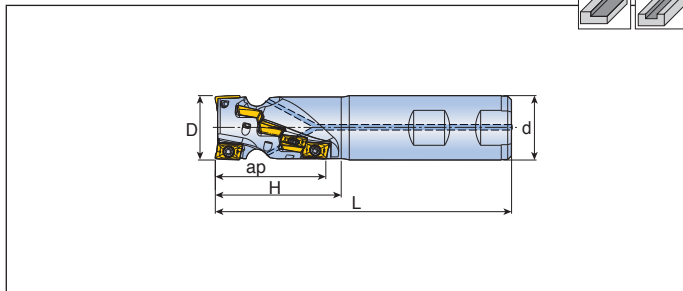

Обозначение		Число пластин	Размеры (мм)					Каналы СОЖ	Пластина
			D	d	L	H	ap		
2S-TEF D20-25-W20-AP09	1	3	20	20	110	38	26	●	APK(C)T 09T3... E200
D25-42-W25-AP09	2	10	25	25	115	48	42	●	
D32-42-W32-AP09	2	10	32	32	120	51	42	●	

Запчасти

Обозначение	Винт	Ключ			
2S-TEF-AP09	TS 25055I/HG	TD8			



TEF/TES-AP12

CHASEMILL

Кукурузная фреза

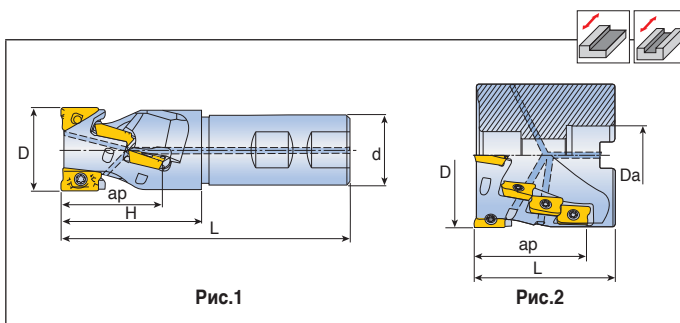

Обозначение	Число пластин	Размеры (мм)							Каналы СОЖ	Кг	Рис.	Крепежный болт	Пластина
		D	d	Da	L	H	ap						
TEF D25-34-W25-AP12	2	6	25	25	-	120	47	34	●	-	1	-	APK(C)T 1204... E202
D32-45-W32-AP12	2	8	32	32	-	120	58	45	●	-	1	-	
D40-45-W32-AP12	3	12	40	32	-	140	65	45	●	-	1	-	
TES D50-45-22R-AP12	4	16	50	-	22	65	-	45	●	0.6	2	SH M10x1.5x40	
D63-56-27R-AP12	5	25	63	-	27	75	-	56	●	1.2	2	SH M10x1.5x50	

• Крепежный болт с каналом под СОЖ доступен по запросу (Пример заказа: SH M10x1.5x30-C)

Запчасти

Обозначение	Винт	Ключ			
	TEF/TES-AP12 (Ø16-Ø25)	TS 35A070I/HG	TD10P		
TEF/TES-AP12 (Ø32-)	TS 35A088I/HG	TD10P			

Режимы резания E241-E243

Исполнение корпуса E244-E245

TEF/TES-AP17

CHASEMILL

Кукурузная фреза

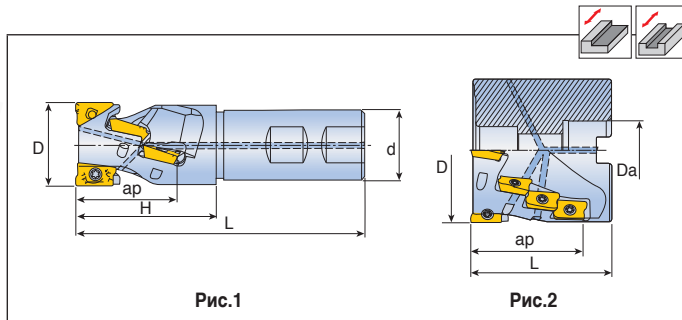

Обозначение		Число пластин	Размеры (мм)						Каналы СОЖ		Рис.	Крепежный болт	Пластина
			D	d	Da	L	H	ap					
TEF D32-30-W32-AP17	2	4	32	32	-	120	50	30	●	-	1	-	APKT 1705... APKT 1706...
D40-44-W32-AP17	2	6	40	32	-	140	65	44	●	-	1	-	
TES D50-44-22-AP17	2	6	50	-	22	60	-	44	●	0.5	2	SH M10x1.5x40	
D63-44-27-AP17	3	9	63	-	27	63	-	44	●	0.9	2	SH M12x1.75x40	
D80-58-32-AP17	4	16	80	-	32	75	-	58	●	1.9	2	SH M16x2x50	
D100-88-40-AP17	5	30	100	-	40	110	-	88	●	4.8	2	SH M20x2.5x80	
D63-44-25.4-AP17	3	9	63	-	25.4	63	-	44	●	0.9	2	SH M12x1.75x40	
D80-58-31.75-AP17	4	16	80	-	31.75	75	-	58	●	1.9	2	SH M16x2x50	
D100-88-38.1-AP17	5	30	100	-	38.1	110	-	88	●	4.8	2	SH M20x2.5x80	

• Крепежный болт с каналом под СОЖ доступен по запросу (Пример заказа: SH M10x1.5x30-C)

Запчасти

Обозначение	Винт	Ключ			
TEF-AP17	TS 40093I/HG	TD15			
TES-AP17	TS 40093I/HG	T-T15			

Режимы резания E241-E243

Исполнение корпуса E244-E245

Кукурузная фреза

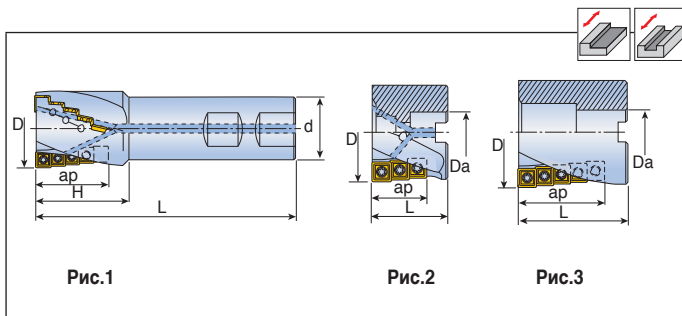

Обозначение		Число пластин	Размеры (мм)					Каналы СОЖ	Рис.	Крепежный болт	Пластина	
			D	Da/d	L	H	ap					
TEF		6	D32-23-W32-09	32	32	120	40	23.8	●	1	-	SPMG(T) 090408-EM
			D40-38-W32-11	40	32	130	60	38.9	●	1	-	SPMG(T)110408-EM
			D50-48-W40-11	50	40	140	70	48.4	●	1	-	
			D50-48-W42-11	50	42	140	70	48.4	●	1	-	
TES		9	D50-29-22-11	50	22	52	-	29.0	●	2	SH M10x1.5x30	SPMG(T) 110408-EM
			D63-35-27-11	63	27	55	-	35.0	●	2	SH M12x1.75x35	
			D80-47-32-14	80	32	65	-	47.0	●	2	SH M16x2x40	SPMG(T)140508-EM
			D100-60-40-14	100	40	88	-	60.0	x	3	-	
TES		16	D63-35-25.4-11	63	25.4	55	-	35.0	●	2	SH M12x1.75x35	SPMG(T) 110408-EM
			D80-47-31.75-14	80	31.75	65	-	47.0	●	2	SH M16x2x40	SPMG(T)140508-EM
			D100-60-38.1-14	100	38.1	88	-	60.0	x	3	-	E228

• Крепежный болт с каналом под СОЖ доступен по запросу (Пример заказа: SH M10x1.5x30-C)

Запчасти

Обозначение	Винт	Ключ			
TEF (Ø32)	TS 35088I	TD 10			
TEF (Ø40-Ø50)	TS 40093I	TD 15			
TES (Ø50-Ø63)	TS 40093I	TD 15			
TES (Ø80-Ø100)	TS 50A121I/HG	T-T20			

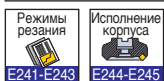

TSM...-W...-TS16

TOP SLOT

Грибковая фреза



Рис.1

Рис.2

Обозначение		Размеры (мм)					Каналы СОЖ	Рис.	кг	Пластина
		D	D ₂	d	L ₁	ap				
TSM D32-W25-3Z-TS16	3	32.2	21.7	25	52.3	1.20-4.0	•	2	0.34	TS16-1.2-4.0
D32-W25-3Z-B-TS16	3	32.2	21.7	25	52.3	4.01-6.0	•	2	0.46	TS16-4.01-6.0
D40-W25-4Z-TS16	4	40.0	29.7	25	30.0	1.20-4.0	•	1	0.44	TS16-1.2-4.0
D40-W25-4Z-B-TS16	4	40.0	29.7	25	30.0	4.01-6.0	•	1	0.53	TS16-4.01-6.0
D50-W32-6Z-TS16	6	50.0	39.7	32	30.0	1.20-4.0	•	1	0.75	TS16-1.2-4.0
										E235

• f: Tmax относится к параметрам пластины

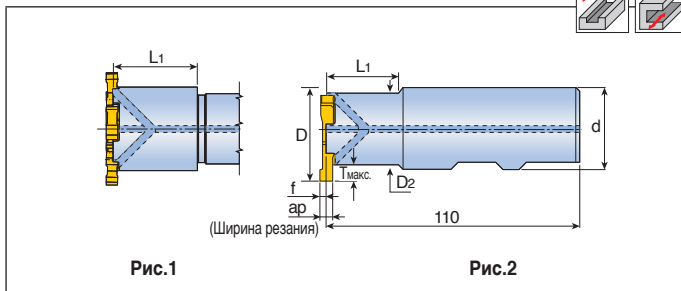
Запчасти

Обозначение	Винт	Ключ			
TSM D32-W25-3Z-TS16	TS 400971-N3.5	BLD T15/S7			
TSM D32-W25-3Z-B-TS16	TS 400971	BLD T15/S7			
TSM D40-W25-4Z-TS16	TS 400971-N3.5	BLD T15/S7			
TSM D40-W25-4Z-B-TS16	TS 400971	BLD T15/S7			
TSM D50-W32-6Z-TS16	TS 400971-N3.5	BLD T15/S7			



TSM...R-TS16

TOPSLOT

Грибковая фреза: фланцевый тип

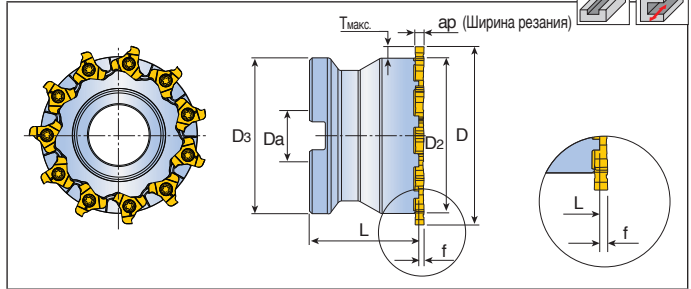

Обозначение		Размеры (мм)						Исполнение корпуса		Пластина
		D	Da	D2	D3	L	ap			
TSM D50-22R-6Z-TS16	6	50	22	39.7	39.7	39	1.20-4.0	A	0.24	TS16-1.20-4.0
D50-22R-6Z-B-TS16	6	50	22	39.7	39.7	39	4.01-6.0	A	0.24	TS16-4.01-6.0
D63-22R-8Z-TS16	8	63	22	52.7	40.0	39	1.20-4.0	A	0.40	TS16-1.20-4.0
D63-22R-8Z-B-TS16	8	63	22	52.7	40.0	39	4.01-6.0	A	0.27	TS16-4.01-6.0
D80-27R-11Z-TS16	11	80	27	69.7	69.7	49	1.20-4.0	B	0.40	TS16-1.20-4.0
D80-27R-11Z-B-TS16	11	80	27	69.7	69.7	49	4.01-6.0	B	0.95	TS16-4.01-6.0
										E235

• f: Tmax относится к параметрам пластины

Запчасти

Обозначение	Винт	Ключ			
TSM D50-22R-6Z-TS16	TS 40097I-N3.5	BLD T15/S7			
TSM D50-22R-6Z-B-TS16	TS 40097I	BLD T15/S7			
TSM D63-22R-8Z-TS16	TS 40097I-N3.5	BLD T15/S7			
TSM D63-22R-8Z-B-TS16	TS 40097I	BLD T15/S7			
TSM D80-27R-11Z-TS16	TS 40097I-N3.5	BLD T15/S7			
TSM D80-27R-11Z-B-TS16	TS 40097I	BLD T15/S7			

 Режимы резания E241-E243	 Исполнение корпуса E244-E245
---------------------------------	-------------------------------------

Грибковая фреза

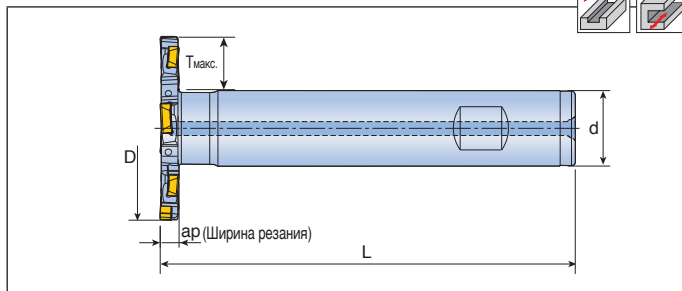
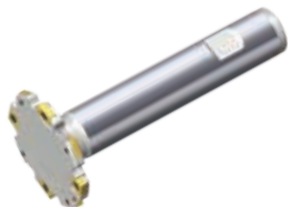

Обозначение	ap (мм)		Размеры (мм)				Каналы СОЖ	Пластина
			D	d	L	T _{макс.}		
TSM D25-03-W12-SL18	3	1+1	25	12	90	6.5	●	SLOT 018...
D32-03-W16-SL18	3	2+2	32	16	90	8.0	●	E223
D40-03-W16-SL18	3	3+3	40	16	105	12.0	●	
D50-03-W20-SL18	3	4+4	50	20	110	15.0	●	
D63-03-W20-SL18	3	5+5	63	20	110	21.5	●	
TSM D25-04-W12-SL23	4	1+1	25	12	90	6.5	●	SLOT 023...
D32-04-W16-SL23	4	2+2	32	16	90	8.0	●	E223
D40-04-W16-SL23	4	3+3	40	16	105	12.0	●	
D50-04-W20-SL23	4	4+4	50	20	110	15.0	●	
D63-04-W20-SL23	4	5+5	63	20	110	21.5	●	
TSM D25-05-W12-SL28	5	1+1	25	12	90	6.5	●	SLOT 028...
D32-05-W16-SL28	5	2+2	32	16	90	8.0	●	E223
D40-05-W16-SL28	5	3+3	40	16	105	12.0	●	
D50-05-W20-SL28	5	4+4	50	20	110	15.0	●	
D63-05-W20-SL28	5	5+5	63	20	110	21.5	●	
TSM D25-06-W12-SL33	6	1+1	25	12	90	6.5	●	SLOT 033...
D32-06-W16-SL33	6	2+2	32	16	90	8.0	●	E223
D40-06-W16-SL33	6	3+3	40	16	105	12.0	●	
D50-06-W20-SL33	6	4+4	50	20	110	15.0	●	
D63-06-W20-SL33	6	5+5	63	20	110	21.5	●	



Грибковая фреза: модульный тип

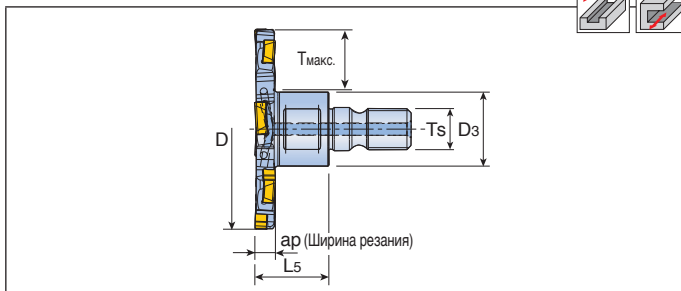

Обозначение	ap (мм)		Размеры (мм)					Каналы СОЖ	Пластина
			D	D3	L5	Ts	Tmax.		
TSM D25-03-M08-SL18	3	1+1	25	13	18	8	6	●	SLOT 018...
D32-03-M08-SL18	3	2+2	32	13	18	8	9	●	E223
D40-03-M08-SL18	3	3+3	40	13	18	8	13	●	●
D50-03-M10-SL18	3	4+4	50	18	18	10	15	●	●
D63-03-M10-SL18	3	5+5	63	18	18	10	22	●	●
TSM D25-04-M08-SL23	4	1+1	25	13	18	8	6	●	SLOT 023...
D32-04-M08-SL23	4	2+2	32	13	18	8	9	●	E223
D40-04-M08-SL23	4	3+3	40	13	18	8	13	●	●
D50-04-M10-SL23	4	4+4	50	18	18	10	15	●	●
D63-04-M10-SL23	4	5+5	63	18	18	10	22	●	●
TSM D25-05-M08-SL28	5	1+1	25	13	18	8	6	●	SLOT 028...
D32-05-M08-SL28	5	2+2	32	13	18	8	9	●	E223
D40-05-M08-SL28	5	3+3	40	13	18	8	13	●	●
D50-05-M10-SL28	5	4+4	50	18	18	10	15	●	●
D63-05-M10-SL28	5	5+5	63	18	18	10	22	●	●
TSM D25-06-M08-SL33	6	1+1	25	13	18	8	6	●	SLOT 033...
D32-06-M08-SL33	6	2+2	32	13	18	8	9	●	E223
D40-06-M08-SL33	6	3+3	40	13	18	8	13	●	●
D50-06-M10-SL33	6	4+4	50	18	18	10	15	●	●
D63-06-M10-SL33	6	5+5	63	18	18	10	22	●	●

• Устанавливается на хвостовик T-FLEXTEC: см. раздел

Запчасти

Обозначение	Винт	Ключ	L-ключ		
TSM...-03...-SL18	TS 25B0241/HG	TD7P	L-T7P		
TSM...-04...-SL23	TS 25B0311/HG	TD7P	L-T7P		
TSM...-05...-SL28	TS 25B0421/HG	TD7P	L-T7P		
TSM...-06...-SL33	TS 25B0531/HG	TD7P	L-T7P		



Дисковая фреза: нерегулируемая

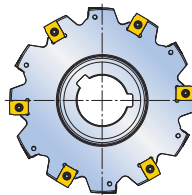
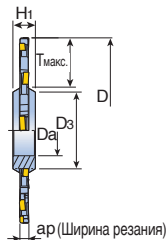
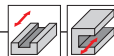

Обозначение	ар (мм)		Размеры (мм)						Пластина
			D	Da	Dз	H1	Tмакс.		
TSM 063FD-03-22N-Z018	3	4+4	63	22	34	8	12.0	0.1	ZNHT 018...
080FD-03-22N-Z018	3	5+5	80	22	34	8	20.5	0.1	E239
100FD-03-27N-Z018	3	6+6	100	27	41	12	26.0	0.2	
125FD-03-40N-Z018	3	7+7	125	40	55	12	31.5	0.3	
160FD-03-40N-Z018	3	9+9	160	40	55	12	49.0	0.4	
TSM 063FD-04-22N-Z023	4	4+4	63	22	34	8	12.0	0.1	ZNHT 023...
080FD-04-22N-Z023	4	5+5	80	22	34	8	21.0	0.1	E239
100FD-04-27N-Z023	4	6+6	100	27	41	12	27.0	0.2	
125FD-04-40N-Z023	4	7+7	125	40	55	12	32.0	0.4	
160FD-04-40N-Z023	4	9+9	160	40	55	12	50.0	0.6	
TSM 063FD-05-22N-Z028	5	4+4	63	22	34	8	13.0	0.1	ZNHT 028...
080FD-05-22N-Z028	5	5+5	80	22	34	8	21.0	0.2	E239
100FD-05-27N-Z028	5	6+6	100	27	41	12	27.0	0.3	
125FD-05-40N-Z028	5	7+7	125	40	55	12	33.0	0.4	
160FD-05-40N-Z028	5	9+9	160	40	55	12	50.0	0.7	
TSM 063FD-06-22N-Z033	6	4+4	63	22	34	8	13.0	0.1	ZNHT 033...
080FD-06-22N-Z033	6	5+5	80	22	34	8	21.5	0.2	E239
100FD-06-27N-Z033	6	6+6	100	27	41	12	27.0	0.3	
125FD-06-40N-Z033	6	7+7	125	40	55	12	33.0	0.5	
160FD-06-40N-Z033	6	9+9	160	40	55	12	50.0	0.8	
200FD-06-50N-Z033	6	10+10	200	50	69	12	63.0	1.2	
250FD-06-50N-Z033	6	12+12	250	50	69	12	88.0	2.0	
TSM 080FD-07-22N-Z038	7	4+4	80	22	34	12	20.0	0.2	ZNHT 038...
100FD-07-27N-Z038	7	5+5	100	27	41	12	26.5	0.3	E239
125FD-07-40N-Z038	7	6+6	125	40	55	12	32.0	0.5	
160FD-07-40N-Z038	7	8+8	160	40	55	12	49.5	0.8	
200FD-07-50N-Z038	7	9+9	200	50	69	12	62.5	1.3	
250FD-07-50N-Z038	7	12+12	250	50	69	12	87.5	1.9	



E241-E243

E254-E257

Дисковая фреза: нерегулируемая

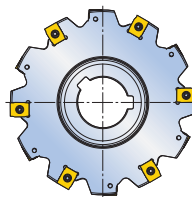
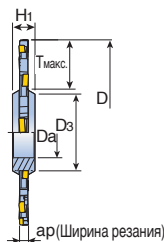
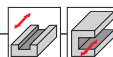

Обозначение	ap (мм)		Размеры (мм)						Пластина
			D	Da	Dз	H1	Tmax.		
TSM 080FD-08-22N-Z043	8	4+4	80	22	34	12	20.5	0.2	ZNHT 043...
100FD-08-27N-Z043	8	5+5	100	27	41	12	27.0	0.3	
125FD-08-40N-Z043	8	6+6	125	40	55	12	32.5	0.5	
160FD-08-40N-Z043	8	8+8	160	40	55	12	50.0	0.9	
200FD-08-50N-Z043	8	9+9	200	50	69	12	63.0	1.4	
250FD-08-50N-Z043	8	12+12	250	50	69	12	88.0	2.3	
TSM 100FD-09-27N-Z048	9	5+5	100	27	41	12	27.5	0.4	ZNHT 048...
125FD-09-40N-Z048	9	6+6	125	40	55	12	33.0	0.6	
160FD-09-40N-Z048	9	8+8	160	40	55	12	50.5	1.0	
200FD-09-50N-Z048	9	9+9	200	50	69	12	63.5	1.6	
250FD-09-50N-Z048	9	12+12	250	50	69	12	88.5	2.6	
TSM 100FD-10-27N-Z053	10	5+5	100	27	41	12	28.0	0.4	ZNHT 053...
125FD-10-40N-Z053	10	6+6	125	40	55	12	33.5	0.6	
160FD-10-40N-Z053	10	8+8	160	40	55	12	51.0	1.3	
200FD-10-50N-Z053	10	9+9	200	50	69	12	64.0	2.0	
250FD-10-50N-Z053	10	12+12	250	50	69	12	89.0	3.2	

• Оправка: SCA

Запчасти

Обозначение	Винт	Ключ	Обозначение	Винт	Ключ
TSM-Z018	TS 25B024I/HG	TD7P/L-T7P	TSM-Z038	TS 40K0535I	T-T15/L-T15
TSM-Z023	TS 25B031I/HG	TD7P/L-T7P	TSM-Z043	TS 40K065I	T-T15/L-T15
TSM-Z028	TS 25B042I/HG	TD7P/L-T7P	TSM-Z048	TS 40K075I	T-T15/L-T15
TSM-Z033	TS 25B053I/HG	TD7P/L-T7P	TSM-Z053	TS 40K085I	T-T15/L-T15



E241-E243

E254-E257

TSM...FD...-ZN08

TOP SLOT

Дисковая фреза: нерегулируемая

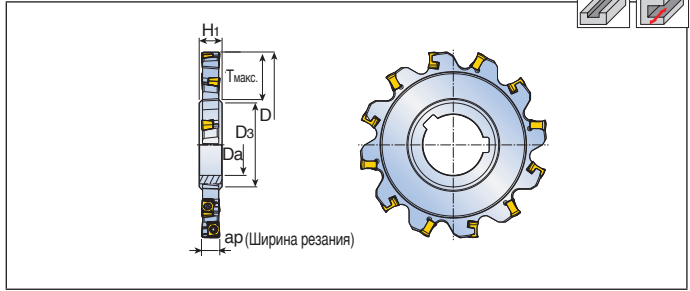
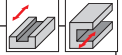

Обозначение	ap (мм)		Размеры (мм)						Пластина
			D	Da	D3	H1	Tmax.		
TSM 080FD-10-27N-ZN08	10.0	4+4	80	27	41	15	15.5	0.3	ZNHU 080... E240
100FD-10-27N-ZN08	10.0	5+5	100	27	41	15	25.5	0.5	
125FD-10-40N-ZN08	10.0	6+6	125	40	55	15	31.0	0.7	
080FD-12-27N-ZN08	12.0	4+4	80	27	41	15	16.5	0.3	
100FD-12-27N-ZN08	12.0	5+5	100	27	41	15	26.5	0.5	
125FD-12-40N-ZN08	12.0	6+6	125	40	55	15	32.0	0.8	

• Оправка: SCA

Запчасти

Обозначение	Винт	Ключ			
TSM...FD...-ZN08	TS 30085/HG	TD9			



Дисковая фреза: регулируемая

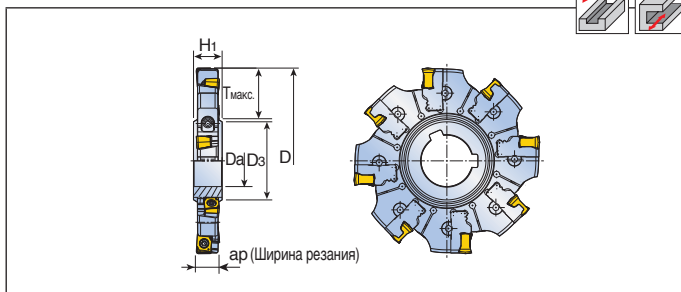
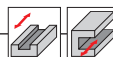

Обозначение	ap (мм)		Размеры (мм)						Пластина	
			D	Da	Dз	H1	Tmax.			
TSM 100FD-S-27N-ZN08	10-12	4+4	100	27	41	15	26.5	0.4	ZNHU 080... E240	
125FD-S-40N-ZN08	10-12	5+5	125	40	55	15	31.5	0.7		
160FD-S-40N-ZN08	10-12	6+6	160	40	55	15	48.5	1.1		
200FD-S-50N-ZN08	10-12	8+8	200	50	69	15	61.5	1.8		
250FD-S-50N-ZN08	10-12	9+9	250	50	69	15	87.5	2.8		
100FD-W-27N-ZN08	12-14	4+4	100	27	41	15	27.0	0.5		
125FD-W-40N-ZN08	12-14	5+5	125	40	55	15	31.5	0.8		
160FD-W-40N-ZN08	12-14	6+6	160	40	55	15	49.5	1.3		
200FD-W-50N-ZN08	12-14	8+8	200	50	69	15	62.5	2.1		
250FD-W-50N-ZN08	12-14	9+9	250	50	69	15	87.5	3.4		

- Фрезы настроены на минимальную ширину резания если не заказана другая ширина
- Оправка: SCA

Запчасти

Обозначение	Правосторонний картридж	Левосторонний картридж	Винт картриджа	Регулировочный винт	Винт пластины
TSM...FD-S/W...-ZN08	TCT-SR-ZN08 TCT-WR-ZN08	TCT-SL-ZN08 TCT-WL-ZN08	WFZ 5	SA M8-6.0	TS 30085/HG
	Винт для клина	Ключ	L-Ключ	Ключ для клина	
	WS 5	TD9	L-W3	F-W2.5	



TSM...FD...-ZN11

TOP SLOT

Дисковая фреза: нерегулируемая

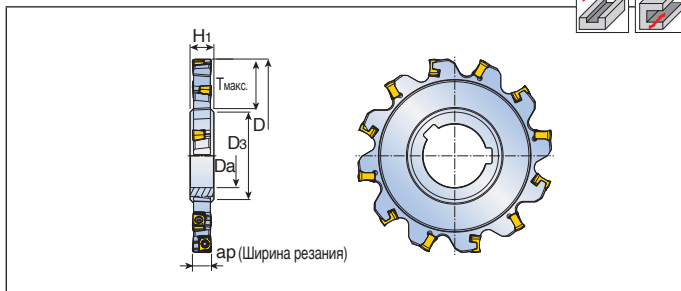
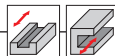

Обозначение	ap (мм)		Размеры (мм)						Пластина
			D	Da	Dз	H1	T _{макс.}		
TSM 125FD-14-40N-ZN11	14.0	6+6	125	40	55	15	34.5	0.9	ZNHU 110... E240
125FD-17-40N-ZN11	17.0	6+6	125	40	55	18	34.5	1.1	
125FD-20-40N-ZN11	20.0	6+6	125	40	55	20	34.5	1.3	

• Оправка: SCA

Запчасти

Обозначение	Винт	Ключ			
TSM...FD...-ZN11	TS 40120/HG	T-T15			



Дисковая фреза: регулируемая

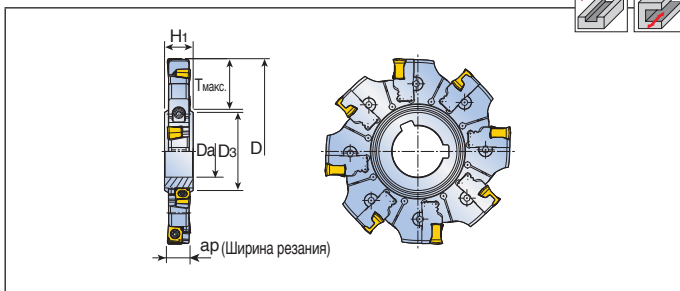
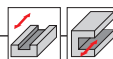

Обозначение	ap (мм)		Размеры (мм)					Kg	Пластина	
			D	Da	Dз	H1	Tmax.			
TSM 100FD-S-27N-ZN11	14-17	3+3	100	27	41	18	28.0	0.6	ZNHU 110... E240	
125FD-S-40N-ZN11	14-17	4+4	125	40	55	18	31.0	1.0		
160FD-S-40N-ZN11	14-17	6+6	160	40	55	18	48.5	1.6		
200FD-S-50N-ZN11	14-17	7+7	200	50	69	18	61.5	2.6		
250FD-S-50N-ZN11	14-17	9+9	250	50	69	18	86.5	4.2		
315FD-S-60N-ZN11	14-17	12+12	315	60	85	18	110.0	6.8		
100FD-W-27N-ZN11	17-20	3+3	100	27	41	22	28.0	0.8		
125FD-W-40N-ZN11	17-20	4+4	125	40	55	22	31.0	1.2		
160FD-W-40N-ZN11	17-20	6+6	160	40	55	22	48.5	2.0		
200FD-W-50N-ZN11	17-20	7+7	200	50	69	22	61.5	3.2		
250FD-W-50N-ZN11	17-20	9+9	250	50	69	22	86.5	5.2		
315FD-W-60N-ZN11	17-20	12+12	315	60	85	22	110.0	8.5		

- Фрезы настроены на минимальную ширину резания если не заказана другая ширина
- Оправка: SCA

Запчасти

Обозначение	Правосторонний картридж	Левосторонний картридж	Винт картриджа	Регулировочный винт	Винт пластины
TSM...FD-S/W...-ZN11	TCT-SR-ZN11	TCT-SL-ZN11	WFZ 6	SA M8-9.0	TS 40120I/HG
	TCT-WR-ZN11	TCT-WL-ZN11			
	Винт для клина	Ключ	L-Ключ	Ключ для клина	
WS 6	T-T15	L-W4	T-W3		

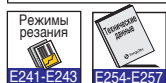

TSM...FD-S/W...-ZN14

TOP SLOT

Дисковая фреза: регулируемая

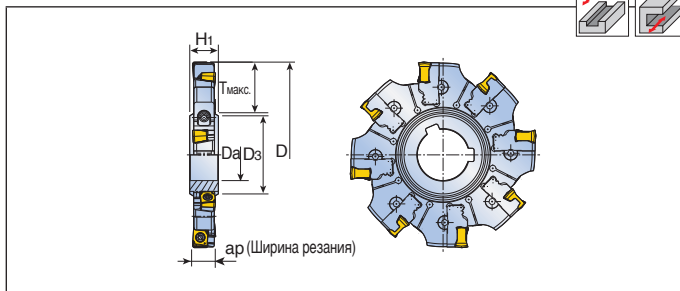
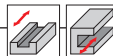

Обозначение	ap (мм)		Размеры (мм)					Kg	Пластина
			D	Da	Dз	H1	Tмакс.		
TSM 125FD-S-40N-ZN14	20-23	3+3	125	40	55	24.5	32.0	1.4	ZNHU 140... E240
160FD-S-40N-ZN14	20-23	5+5	160	40	55	24.5	49.0	2.4	
200FD-S-50N-ZN14	20-23	6+6	200	50	69	24.5	62.5	3.9	
250FD-S-50N-ZN14	20-23	8+8	250	50	69	24.5	87.0	6.3	
315FD-S-60N-ZN14	20-23	10+10	315	60	85	24.5	111.5	10.2	
125FD-W-40N-ZN14	23-26	3+3	125	40	55	27.5	32.0	1.6	
160FD-W-40N-ZN14	23-26	5+5	160	40	55	27.5	49.0	2.7	
200FD-W-50N-ZN14	23-26	6+6	200	50	69	27.5	62.5	4.3	
250FD-W-50N-ZN14	23-26	8+8	250	50	69	27.5	87.0	7.1	
315FD-W-60N-ZN14	23-26	10+10	315	60	85	27.5	111.5	11.6	

- Фрезы настроены на минимальную ширину резания если не заказана другая ширина
- Оправка: SCA

Запчасти

Обозначение	Правосторонний картридж	Левосторонний картридж	Винт картриджа	Регулировочный винт	Винт пластины
TSM...FD-S/W...-ZN14	TCT-SR-ZN14	TCT-SL-ZN14	WFZ 6	SA M8-9.0	TS 401201/HG
	Винт для клина	Ключ	L-Ключ	Ключ для клина	
	WS 6	T-T15	L-W4	T-W3	



Дисковая фреза: нерегулируемая фланцевого типа

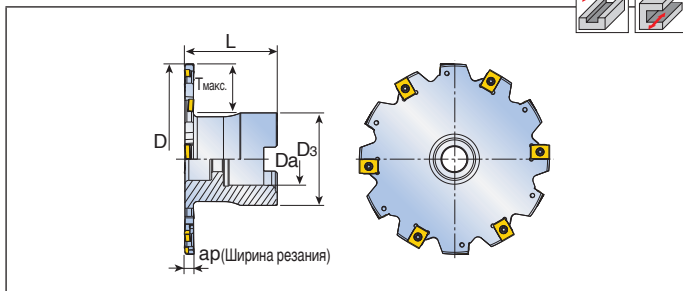
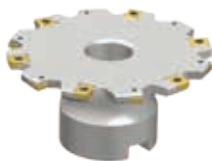
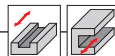

Обозначение	ap (мм)		Размеры (мм)					Исполнение корпуса		Крепежный болт	Пластина
			D	Da	D3	L	Tmax.				
TSM 080FF-03-22R-Z018	3	5+5	80	22	40	50	20.0	A	0.4	SH M10x1.5x35	ZNHT 018...
100FF-03-27R-Z018	3	6+6	100	27	48	50	26.0	A	0.6	SH M12x1.75x35	ZNHT 023...
080FF-04-22R-Z023	4	5+5	80	22	40	50	20.0	A	0.4	SH M10x1.5x35	
100FF-04-27R-Z023	4	6+6	100	27	48	50	26.0	A	0.6	SH M12x1.75x35	
080FF-05-22R-Z028	5	5+5	80	22	40	50	20.0	A	0.5	SH M10x1.5x35	ZNHT 028...
100FF-05-27R-Z028	5	6+6	100	27	48	50	26.0	A	0.7	SH M12x1.75x35	ZNHT 033...
080FF-06-22R-Z033	6	5+5	80	22	40	50	20.0	A	0.5	SH M10x1.5x35	
100FF-06-27R-Z033	6	6+6	100	27	48	50	26.0	A	0.7	SH M12x1.75x35	
125FF-06-40R-Z033	6	7+7	125	40	70	50	25.0	B	1.1	-	ZNHT 038...
160FF-06-40R-Z033	6	9+9	160	40	70	50	43.0	B	1.4	-	
080FF-07-22R-Z038	7	4+4	80	22	40	50	20.0	A	0.5	SH M10x1.5x40	
100FF-07-27R-Z038	7	5+5	100	27	48	50	25.5	A	0.7	SH M12x1.75x35	ZNHT 043...
125FF-07-40R-Z038	7	6+6	125	40	70	50	24.5	B	1.1	-	ZNHT 048...
160FF-07-40R-Z038	7	8+8	160	40	70	50	42.0	B	1.4	-	
080FF-08-22R-Z043	8	4+4	80	22	40	50	20.0	A	0.5	SH M10x1.5x35	
100FF-08-27R-Z043	8	5+5	100	27	48	50	25.5	A	0.8	SH M12x1.75x35	ZNHT 053...
125FF-08-40R-Z043	8	6+6	125	40	70	50	24.5	B	1.2	-	ZNHT 058...
160FF-08-40R-Z043	8	8+8	160	40	70	50	42.0	B	1.5	-	
100FF-09-27R-Z048	9	5+5	100	27	48	50	26.0	A	0.7	SH M12x1.75x35	
125FF-09-40R-Z048	9	6+6	125	40	70	50	24.5	B	1.2	-	ZNHT 063...
160FF-09-40R-Z048	9	8+8	160	40	70	50	42.0	B	1.6	-	
100FF-10-27R-Z053	10	5+5	100	27	48	50	26.0	A	0.8	SH M12x1.75x35	
125FF-10-40R-Z053	10	6+6	125	40	70	50	24.5	B	1.4	-	ZNHT 068...
160FF-10-40R-Z053	10	8+8	160	40	70	50	42.0	B	1.7	-	

Запчасти

Обозначение	Винт	Ключ	Обозначение	Винт	Ключ
TSM-Z018	TS 25B0241/HG	TD7P/L-T7P	TSM-Z038	TS 40K05351	T-T15/L-T15
TSM-Z023	TS 25B0311/HG	TD7P/L-T7P	TSM-Z043	TS 40K0651	T-T15/L-T15
TSM-Z028	TS 25B0421/HG	TD7P/L-T7P	TSM-Z048	TS 40K0751	T-T15/L-T15
TSM-Z033	TS 25B0531/HG	TD7P/L-T7P	TSM-Z053	TS 40K0851	T-T15/L-T15



Дисковая фреза: нерегулируемая фланцевого типа

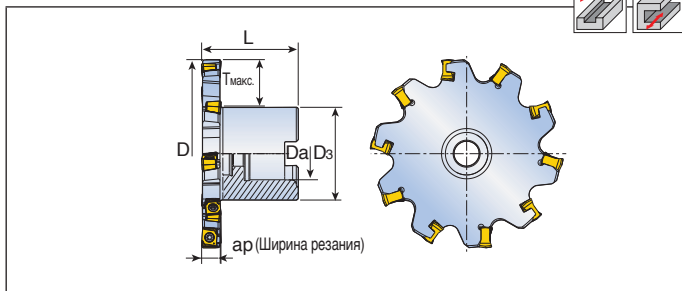
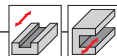

Обозначение	ap (мм)		Размеры (мм)					Исполнение корпуса	Kg	Крепежный болт	Пластина
			D	Da	Dз	L	T _{макс.}				
TSM 063FF-10-22R-ZN08	10.0	3+3	63	22	40	50	15	A	0.4	SH M10x1.5x35	ZNHU 080... E240
080FF-10-22R-ZN08	10.0	4+4	80	22	40	50	24	A	0.5	SH M10x1.5x35	
100FF-10-27R-ZN08	10.0	5+5	100	27	48	50	26	A	0.8	SH M12x1.75x35	
125FF-10-32R-ZN08	10.0	6+6	125	32	58	50	34	B	1.1	-	
063FF-12-22R-ZN08	12.0	3+3	63	22	40	50	15	A	0.4	SH M10x1.5x35	
080FF-12-22R-ZN08	12.0	4+4	80	22	40	50	24	A	0.5	SH M10x1.5x35	
100FF-12-27R-ZN08	12.0	5+5	100	27	48	50	26	A	0.9	SH M12x1.75x35	
125FF-12-32R-ZN08	12.0	6+6	125	32	58	50	34	B	1.2	-	

Запчасти

Обозначение	Винт	Ключ			
TSM...FF...-ZN08	TS 30085I/HG	TD9			

Режимы резания E241-E243	Исполнение корпуса E244-E245	Типы дисков E254-E257
-----------------------------	---------------------------------	--------------------------

Дисковая фреза: регулируемая фланцевого типа

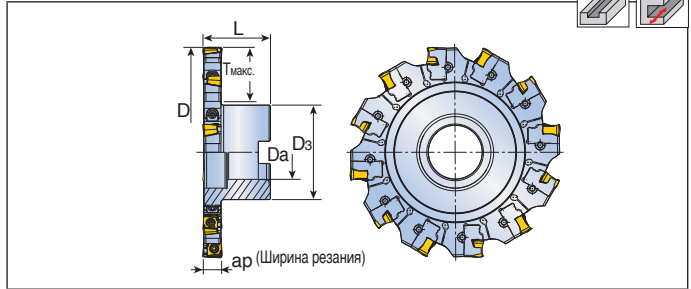

Обозначение	ap (мм)		Размеры (мм)						Исполнение корпуса	Kg	Крепежный болт	Пластина
			D	Da	D3	L	T _{max}	ap				
TSM 100FF-S-27R-ZN08	10-12	4+4	100	27	48	50	25	A	0.8	SH M12x1.75x35	ZNHU 080...	
125FF-S-32R-ZN08	10-12	5+5	125	32	58	50	31.5	B	1.1	-	E240	
160FF-S-40R-ZN08	10-12	6+6	160	40	70	50	43	B	1.8	-		
200FF-S-40R-ZN08	10-12	8+8	200	40	90	50	53	C	2.9	-		
100FF-W-27R-ZN08	12-14	4+4	100	27	48	50	25	A	0.9	SH M12x1.75x35		
125FF-W-32R-ZN08	12-14	5+5	125	32	58	50	31.5	B	1.2	-		
160FF-W-40R-ZN08	12-14	6+6	160	40	70	50	43	B	2.0	-		
200FF-W-40R-ZN08	12-14	8+8	200	40	90	50	53	C	3.2	-		

• Фрезы настроены на минимальную ширину резания если не заказана другая ширина

Запчасти

Обозначение	Правосторонний картридж	Левосторонний картридж	Винт картриджа	Регулировочный винт	Винт пластины
TSM...FF-S/W...-ZN08	 TCT-SR-ZN08 TCT-WR-ZN08	 TCT-SL-ZN08 TCT-WL-ZN08	 WFZ 5	 SA M8-6.0	 TS 30085/HG
	 WS 5	 Ключ	 L-Ключ	 Ключ для клина	
		 TD9	 L-W3	 F-W2.5	

 Режимы резания E241-E243	 Исполнение корпуса E244-E245	 Пластина E254-E257
---------------------------------	-------------------------------------	---------------------------

Дисковая фреза: нерегулируемая фланцевого типа

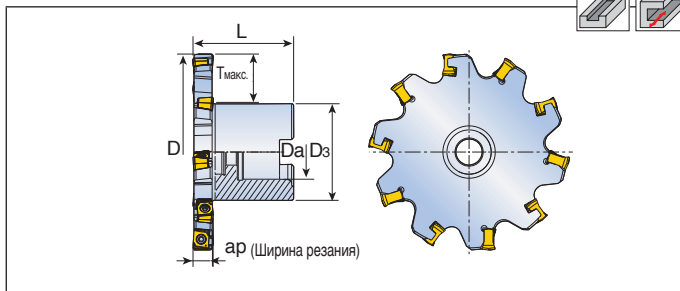
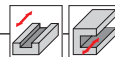

Обозначение	ap (мм)		Размеры (мм)					Исполнение корпуса		Крепежный болт	Пластина
			D	Da	Dз	L	T _{макс.}				
TSM 063FF-14-22R-ZN11	14.0	3+3	63	22	40	50	15	A	0.4	SH M10x1.5x35	ZNHU 110... E240
080FF-14-22R-ZN11	14.0	4+4	80	22	40	50	24	A	0.5	SH M10x1.5x35	
100FF-14-27R-ZN11	14.0	5+5	100	27	48	50	26	A	1.0	SH M12x1.75x35	
125FF-14-32R-ZN11	14.0	6+6	125	32	58	50	34	B	1.3	-	
160FF-14-40R-ZN11	14.0	6+6	160	40	70	50	43	B	2.5	-	
080FF-17-22R-ZN11	17.0	4+4	80	22	40	50	24	A	0.6	SH M10x1.5x35	
100FF-17-27R-ZN11	17.0	5+5	100	27	48	50	26	A	1.0	SH M12x1.75x35	
125FF-17-32R-ZN11	17.0	6+6	125	32	58	50	34	B	1.5	-	
080FF-20-22R-ZN11	20.0	4+4	80	22	40	50	24	A	0.7	SH M10x1.5x35	
100FF-20-27R-ZN11	20.0	5+5	100	27	48	50	26	A	1.1	SH M12x1.75x35	
125FF-20-32R-ZN11	20.0	6+6	125	32	58	50	34	B	1.6	-	

Запчасти

Обозначение	Винт	Ключ			
TSM...FF...-ZN11	TS 40120I/HG	T-T15			



Дисковая фреза: регулируемая фланцевого типа

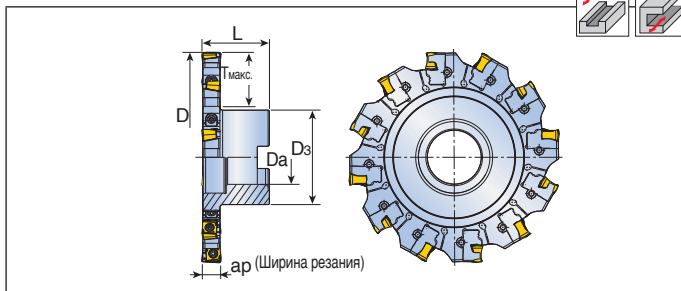

Обозначение	ap (мм)		Размеры (мм)						Исполнение корпуса	кг	Крепежный болт	Пластина
			D	Da	Dз	L	T макс.					
TSM 100FF-S-27R-ZN11	14-17	3+3	100	27	48	50	25.0	A	0.9	SH M12x1.75x35	ZNHU 110...	
125FF-S-32R-ZN11	14-17	4+4	125	32	58	50	31.5	B	1.3	-	E240	
160FF-S-40R-ZN11	14-17	6+6	160	40	70	50	43.0	B	2.2	-		
200FF-S-40R-ZN11	14-17	7+7	200	40	90	50	53.0	C	3.9	-		
250FF-S-60R-ZN11	14-17	9+9	250	60	130	50	55.0	C	6.2	-		
315FF-S-60R-ZN11	14-17	12+12	315	60	130	50	90.0	C	8.9	-		
100FF-W-27R-ZN11	17-20	3+3	100	27	48	50	25.0	A	1.0	SH M12x1.75x35		
125FF-W-32R-ZN11	17-20	4+4	125	32	58	50	31.5	B	1.5	-		
160FF-W-40R-ZN11	17-20	6+6	160	40	70	50	43.0	B	2.2	-		
200FF-W-40R-ZN11	17-20	7+7	200	40	90	50	53.0	C	4.1	-		
250FF-W-60R-ZN11	17-20	9+9	250	60	130	50	55.0	C	6.9	-		
315FF-W-60R-ZN11	17-20	12+12	315	60	130	50	90.0	C	10.2	-		

• Фрезы настроены на минимальную ширину резания если не заказана другая ширина

Запчасти

Обозначение	Правосторонний картридж	Левосторонний картридж	Винт картриджа	Регулировочный винт	Винт пластины
TSM...FD-S/W...-ZN11	TCT-SR-ZN11	TCT-SL-ZN11	WFZ 6	SA M8-9.0	TS 40120I/HG
	TCT-WR-ZN11	TCT-WL-ZN11			
	Винт для клина	Ключ	L-Ключ	Ключ для клина	
	WS 6	T-T15	L-W4	T-W3	



Дисковая фреза: регулируемая фланцевая типа

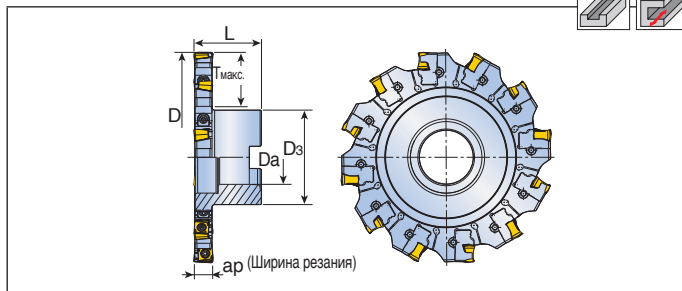
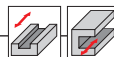

Обозначение	ap (мм)		Размеры (мм)						Исполнение корпуса	Kg	Пластина
			D	Da	Dз	L	T _{макс.}				
TSM 125FF-S-32R-ZN14	20-23	3+3	125	32	58	50	32.5	B	2.6	ZNHU 140... E240	
160FF-S-40R-ZN14	20-23	5+5	160	40	70	50	43.0	B	2.8		
200FF-S-40R-ZN14	20-23	6+6	200	40	90	50	53.0	C	4.6		
250FF-S-60R-ZN14	20-23	8+8	250	60	130	50	58.0	C	7.2		
315FF-S-60R-ZN14	20-23	10+10	315	60	130	50	90.0	C	11.3		
125FF-W-32R-ZN14	23-26	3+3	125	32	58	50	32.5	B	1.8		
160FF-W-40R-ZN14	23-26	5+5	160	40	70	50	43.0	B	3.0		
200FF-W-40R-ZN14	23-26	6+6	200	40	90	50	53.0	C	5.0		
250FF-W-60R-ZN14	23-26	8+8	250	60	130	50	58.0	C	7.5		
315FF-W-60R-ZN14	23-26	10+10	315	60	130	50	90.0	C	12.2		

• Фрезы настроены на минимальную ширину резания если не заказана другая ширина

Запчасти

Обозначение	Правосторонний картридж	Левосторонний картридж	Винт картриджа	Регулировочный винт	Винт пластины
TSM...FD-S/W...-ZN14	TCT-SR-ZN14	TCT-SL-ZN14	WFZ 6	SA M8-9.0	TS 401201/HG
	Винт для клина	Ключ	L-Ключ	Ключ для клина	
	WS 6	T-T15	L-W4	T-W3	



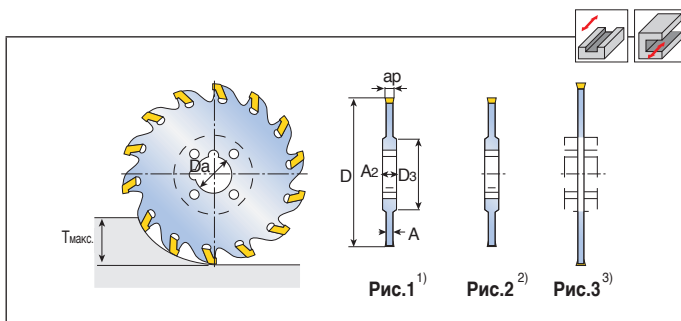

Обозначение	ap (мм)		Размеры (мм)						Рис.	Размер гнезда пластины	Пластина
			D	Da	D3	A	A2	Tмакс.			
TSC 75 1.6 22A	1.6	8	75	22.0	39	1.24	2.4	18	1	1	TIMC TIMJ TIPV E230-E232
100 1.6 22A	1.6	10	100	22.0	39	1.24	2.4	30	1	1	
125 1.6 27A	1.6	12	125	27.0	64	1.24	2.4	30	1	1	
75 2 22A	2.0-2.3	8	75	22.0	39	1.6	2.4	18	1	2	
100 2 22A	2.0-2.3	10	100	22.0	39	1.6	2.4	30	1	2	
125 2 27A	2.0-2.3	12	125	27.0	64	1.6	2.4	30	1	2	
100 2.4 22K	2.3-2.5	10	100	22.0	46	1.9	2.4	26	2	2	
125 2.4 32K	2.3-2.5	12	125	32.0	55	1.9	2.4	34	2	2	
160 2.4 32K	2.3-2.5	16	160	32.0	55	1.9	2.4	52	2	2	
100 3 22K	2.8-3.58	6	100	22.0	-	2.4	-	26	3	4	
125 3 32K	2.8-3.53	8	125	32.0	-	2.4	-	34	3	4	
160 3 40K	2.8-3.53	10	160	40.0	-	2.4	-	39	3	4	
100 4 22K	3.54-4.52	6	100	22.0	-	3.2	-	27	3	4	
125 4 32K	3.54-4.52	8	125	32.0	-	3.2	-	34	3	4	
160 4 40K	3.54-4.52	10	160	40.0	-	3.2	-	39	3	4	

• ¹⁾Шпонка ²⁾Фланец ³⁾Фланец+Хвостовик

Запчасти

Обозначение	Приводной фланец	Хвостовик			
TSC-2.4-22K	TR22-46	-			
TSC-2.4-32K	TR32-55	-			
TSC-22K	TR22-46	TW32-40			
TSC-32K	TR32-55	T32-55			
TSC-40K	TR40-80	T40-80			



- Извлекатель пластин (ESG 1) комплектуется с каждой фрезой
- Набор комплектующих должен быть заказан отдельно

Фрезерные пластины



Система обозначения режущих пластин



1 Форма

											Специальная
A	B	C	H	L	O	P	R	S	T	W	X

2 Задний угол

B	C	D	E	F	G	N	P
5°	7°	15°	20°	25°	30°	0°	11°

3 Допуск

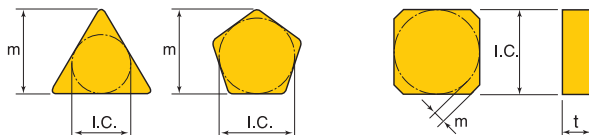

Класс	Допуск, мм			Размер I.C., мм					
	m	t	I.C.	6.35	9.525	12.7	15.875	19.05	25.4
A	±0.005	±0.025	±0.025	•	•	•	•	•	•
E	±0.025	±0.025	±0.025	•	•	•	•	•	•
F	±0.005	±0.025	±0.013	•	•	•	•	•	•
G	±0.025	±0.130	±0.025	•	•	•	•	•	•
H	±0.013	±0.025	±0.013	•	•	•	•	•	•
K	±0.013	±0.025	±0.05	•	•				
			±0.08			•			
			±0.10				•	•	
			±0.13						•
M	±0.130	±0.130	±0.05	•	•				
			±0.08			•			
			±0.10				•	•	
			±0.13						•

4 Форма стружколома и способ крепления

								Специальная
A	F	G	M	N	R	T	W	X

Система обозначения режущих пластин



5 Длина режущей кромки

I.C (мм)	C	R,S	T	H	O
	5.56				
6.35	06	06	11		
7.94	08		13		
9.525	09	09	16		
12.7	12	12	22	05	05
15.875	16	15	27	09	
25.4	25	25			

6 Толщина(мм)

	t
	t
01	1.59
02	2.38
03	3.18
T3	3.97
04	4.76
05	5.56
06	6.35
07	7.94
09	9.52

7 Радиус при вершине(мм)

	r
02R	0.2
04R	0.4
05R	0.5
08R	0.8
10R	1.0
12R	1.2
15R	1.5
16R	1.6
24R	2.4
32R	3.2
40R	4.0

7 Углы

A=45° D=60° E=75° F=85° P=90° Z=Особое
Угол в плане
B= 5° F=25° C= 7° G=30° D=15° N= 0° E=20° P=11° Z=Особое
Задний угол пластины

8 Форма режущей кромки

F	
E	
T	
S	

9 Направление резания

R	
L	
N	

10 Стружколомы

AL	Алюминий
WC	Wiper
MR	Черновой
M	Получерновой
L	Чистовой
ML	Получистовой
E□□	Экономичный

Пластина

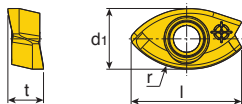

Габарит	Размеры (мм)					
	l	d1	t	ap	r	
160-M	12.4	6.8	3.7	8.0	8.0	
200-M	14.9	8.2	4.8	10.0	10.0	
250-M	18.9	10.2	5.9	12.5	12.5	
300-M	22.1	11.8	6.9	15.0	15.0	
320-M	23.9	12.8	7.5	16.0	16.0	



Пластина	Обозначение	Рекомендованные режимы резания		Покрытие							Без покрытия			
		Подача (мм/зуб)	ap (мм)	TT9080	TT9030	TT8080	TT8020	TT7800	TT7080	TT7515	TT6080	TT2510	K10	
	2FB 160-M	0.07-0.30	2.0-6.5	●		●	●	●				●		
	200-M	0.08-0.35	3.0-8.0	●		●	●	●				●		
	250-M	0.08-0.35	3.5-10.0	●		●	●	●				●		
	300-M	0.08-0.40	4.0-12.5	●		●	●	●				●		
	320-M	0.08-0.40	4.5-13.0	●		●	●	●				●		

● Стандартное наименование



2PKT 05

CHASEMILLPOWER

Пластина

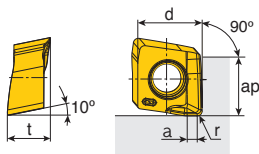

Габарит	Размеры (мм)					
	d	t	ap	a	r	
05	5.17	3.4	4.7	0.4-0.8	0.4-1.6	

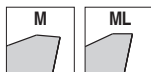

Пластина	Обозначение	Рекомендованные режимы резания		Покрытие							Без покрытия		
		Подача (мм/зуб)	ap (мм)	TT9080	TT8080	TT8020	TT7800	TT7080	TT7515	TT6080	TT2510	K10	
	2PKT 050304R-M	0.06-0.18	0.5-4.2	●	●				●	●	●		
	050308R-M	0.06-0.18	0.5-4.2	●	●				●	●	●		
	050316R-M	0.06-0.18	0.5-4.2	●	●				●	●	●		
	2PKT 050304R-ML	0.02-0.12	0.5-4.2	●	●					●			
	050308R-ML	0.06-0.18	0.5-4.2	●	●				●	●			
	050316R-ML	0.06-0.18	0.5-4.2	●	●				●	●			

● Стандартное наименование



Пластина

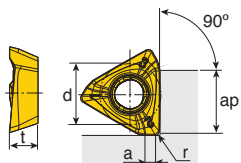

Габарит	Размеры (мм)				
	d	t	ap	a	r
06	5.3	2.8	4.7	0.6-1.2	0.2-0.8
10	6.9	4.0	7.0	0.5-1.3	0.4-1.6
15	10.7	5.0	11.0	0.5-2.0	0.4-2.4
19	13.5	6.0	15.0	0.5-2.0	0.4-3.2

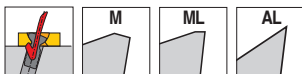

Пластина	Обозначение	Рекомендованные режимы резания		Керамика								Покрытие		Без покрытия	
		Подача (мм/зуб)	ap (мм)	CT7000	TT9080	TT8080	TT8020	TT7800	TT7080	TT7515	TT6080	TT2510	K10		
	ЗПКТ 060302R-M	0.04-0.10	1.0-4.0		●	●	●					●			
	060304R-M	0.04-0.10	1.0-4.0		●	●						●			
	060308R-M	0.04-0.10	1.0-4.0		●	●						●			
	100404R-M	0.05-0.12	2.0-6.0		●	●	●		●	●	●	●			
	100408R-M	0.05-0.12	2.0-6.0		●	●	●		●	●	●	●			
	100416R-M	0.05-0.12	2.0-6.0		●							●			
	150508R-M	0.07-0.17	3.0-9.0		●	●	●	●	●	●	●	●			
	150516R-M	0.07-0.17	3.0-9.0		●				●			●			
	150524R-M	0.07-0.17	3.0-12.0		●							●			
	190608R-M	0.09-0.22	4.5-12.0		●	●	●	●	●	●	●	●			
	190616R-M	0.09-0.22	4.5-12.0		●	●	●		●			●			
	190624R-M	0.09-0.22	4.5-12.0		●							●			
190632R-M	0.09-0.22	4.5-12.0		●							●				
	ЗПНТ 100404R-M	0.05-0.12	2.0-6.0	●	●										
	100408R-M	0.05-0.12	2.0-6.0	●	●										
	150504R-M	0.07-0.17	3.0-9.0		●										
	150508R-M	0.07-0.17	3.0-9.0	●	●										
	150516R-M	0.07-0.17	3.0-9.0	●	●							●			
	190608R-M	0.09-0.22	4.5-12.0	●	●										
	ЗПКТ 100404R-ML	0.04-0.10	2.0-6.0		●	●	●					●			
	100408R-ML	0.04-0.10	2.0-6.0		●	●	●								
	150508R-ML	0.05-0.12	3.0-9.0		●	●	●					●			
	190608R-ML	0.06-0.14	4.5-12.0		●	●	●					●			
	ЗПНТ 100408R-ML	0.04-0.10	2.0-6.0		●	●									
	150508R-ML	0.05-0.12	3.0-9.0		●	●									
	ЗПНТ 060304R-AL	0.07-0.22	1.0-4.0											●	
	100404R-AL	0.10-0.40	2.0-6.0											●	
	100408R-AL	0.10-0.40	2.0-6.0											●	
	150504R-AL	0.10-0.50	3.0-9.0											●	
	150508R-AL	0.10-0.50	3.0-9.0											●	
	190604R-AL	0.15-0.50	4.5-12.0											●	
	190608R-AL	0.15-0.50	4.5-12.0											●	

●: Стандартное наименование



Пластины Splitter

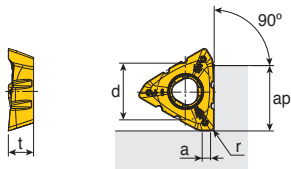

Габарит	Размеры (мм)					
	d	t	ap	a	r	
15	10.7	5.0	11.0	1.6	0.8	
19	13.5	6.0	15.0	2.0	0.8	



Пластина	Обозначение	Рекомендованные режимы резания		Покрытие								Без покрытия		
		Подача (мм/зуб)	ap (мм)	Керамика	TT9080	TT8080	TT8020	TT7800	TT7080	TT7515	TT6080	TT2510	K10	
	ЗПКТ 150508-SM2	0.07-0.17	3.0-9.0		●	●		●			●			
	190608-SM2	0.09-0.22	4.5-12.0		●	●		●			●			
	ЗПКТ 150508-SM3	0.07-0.17	3.0-9.0		●	●		●			●			
	190608-SM3	0.09-0.22	4.5-12.0		●	●		●			●			

●: Стандартное наименование



4NKT 06



Пластина

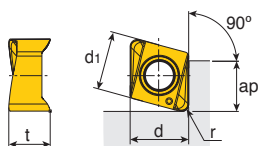

Габарит	Размеры (мм)					
	d	d1	t	ap	r	
06	6.6	6.6	4.6	5.5-6.0	0.8-1.6	



Пластина	Обозначение	Рекомендованные режимы резания		Покрытие							Без покрытия		
		Подача (мм/зуб)	ap (мм)	TT9080	TT8080	TT8020	TT7800	TT7080	TT7515	TT6080	TT2510	K10	
	4NKT 060308R-M	0.07-0.15	1.0-5.0	●	●				●	●			
	060316R-M	0.07-0.15	2.0-4.5	●	●				●	●	○		
	4NKT 060308R-ML	0.05-0.10	1.0-5.0	●	●				●	●			
	060316R-ML	0.05-0.10	2.0-4.5	●	●				●	●			

●: Стандартное наименование
○: Полустандартная позиция



Пластина

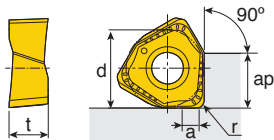

Габарит	Размеры (мм)				
	d	t	ap	a	r
06	9.26	4.76	6.2	1.2-2.4	0.4-1.6
09	13.05	6.70	9.2	1.2-2.2	0.4-1.6



Пластина	Обозначение	Рекомендованные режимы резания		Покрытие								Без покрытия	
		Подача (мм/зуб)	ap (мм)	TT9080	TT8080	TT8020	TT7800	TT7080	TT7515	TT6080	TT2510	K10	
	6NGU 060404R-M	0.08-0.15	1.5-5.0	●	●			●		●	●		
	060405R-M	0.08-0.15	1.5-5.0	●							●		
	060408R-M	0.08-0.15	1.5-5.0	●	●	●	●	●	●	●	●		
	060410R-M	0.08-0.15	1.5-5.0	●							●		
	060416R-M	0.08-0.15	1.5-5.0	●	●			●		●	●		
	090504R-M	0.10-0.20	2.5-7.5	●	●			●		●	●		
	090508R-M	0.10-0.20	2.5-7.5	●	●	●	●	●	●	●	●		
	090516R-M	0.10-0.20	2.5-7.5	●	●		●	●	●	●	●		
	6NGU 060404R-ML	0.05-0.10	1.5-5.0	●	●					●			
	060405R-ML	0.05-0.10	1.5-5.0	●									
	060408R-ML	0.05-0.10	1.5-5.0	●	●	●		●		●			
	060416R-ML	0.05-0.10	1.5-5.0	●	●					●			
	090504R-ML	0.05-0.10	2.5-7.5	●	●					●			
	090508R-ML	0.05-0.10	2.5-7.5	●	●	●		●		●			
	090516R-ML	0.05-0.10	2.5-7.5	●	●					●			
	6NGU 060404R-AL	0.10-0.40	1.5-5.0									●	
	060408R-AL	0.10-0.40	1.5-5.0									●	
	090504R-AL	0.10-0.40	2.5-7.5									●	
	090508R-AL	0.10-0.40	2.5-7.5									●	

● Стандартное наименование



6NKU 04



Пластина

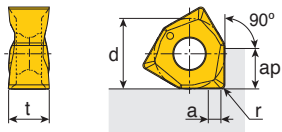

Габарит	Размеры (мм)					
	d	t	ap	a	r	
04	7	3.9	4.1	0.85-1.25	0.4-0.8	



Пластина	Обозначение	Рекомендованные режимы резания		Покрытие							Без покрытия		
		Подача (мм/зуб)	ap (мм)	TT9080	TT8080	TT8020	TT7800	TT7080	TT7515	TT6080	TT2510	K10	
	6NKU 040304R-M	0.05-0.10	1.0-3.0	●	●				●	●	●		
	040308R-M	0.05-0.10	1.0-3.0	●	●				●	●	●		



● Стандартное наименование

6RBE



Пластина

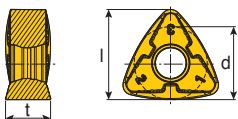

Габарит	Размеры (мм)					
	d	t	l			
6RBE 50	13	8	16			



Пластина	Обозначение	Рекомендованные режимы резания		Покрытие							Без покрытия		
		Подача (мм/зуб)	ap (мм)	TT9080	TT9030	TT8080	TT8020	TT7800	TT7080	TT7515	TT6080	TT2510	K10
	6RBE 50-M	0.10-0.80	1.0-5.0	●		●	●	●		●	●	●	
	50-MR	0.10-0.80	1.0-5.0	●		●	●	●		●	●	●	



● Стандартное наименование

E150-E151

Пластина

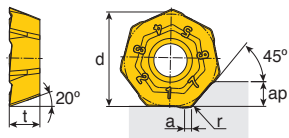

Габарит	Размеры (мм)					
	d	t	ap	a	r	
06	12.8	4.2	3.2	1	0.8	



Пластина	Обозначение	Рекомендованные режимы резания		Покрытие							Без покрытия		
		Подача (мм/зуб)	ap (мм)	TT9080	TT8080	TT8020	TT7800	TT7080	TT7515	TT6080	TT2510	K10	
	7EMT 0604 AETR-M	0.06-0.15	2.5	●	●					●			
	7EMT 0604 AETR-ML	0.06-0.15	2.5	●	●					●			



● Стандартное наименование

ANHX 1607 ANR-M

Пластина

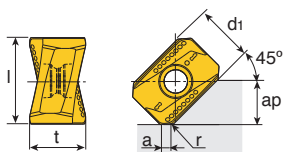

Габарит	Размеры (мм)					
	l	d1	t	ap	a	r
16	16	11	10.4	8.2	1.6	1.0



Пластина	Обозначение	Рекомендованные режимы резания		Покрытие							Без покрытия		
		Подача (мм/зуб)	ap (мм)	TT9080	TT9030	TT8080	TT8020	TT7800	TT7080	TT7515	TT6080	K10	
	ANHX 1607 ANR-M	0.15-0.3	2.5-7.0			●		●	●		●		



● Only for 45° cutter

● Стандартное наименование

Пластина

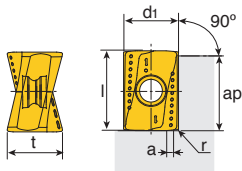

Габарит	Размеры (мм)					
	l	d1	t	ap	a	r
11	12	9,2	8,5	11	0,7-1,5	0,4-1,6
16	16	11,0	10,4-10,9	15	0,6-1,7	0,4-2,4



Пластина	Обозначение	Рекомендованные режимы резания		Покрытие							Без покрытия		
		Подача (мм/зуб)	ap (мм)	TT9080	TT9030	TT8080	TT8020	TT7800	TT7080	TT7515	TT6080	TT2510	K10
	ANMX110608R-M	0.10-0.20	3.0-9.0	●		●							
	160708R-M	0.10-0.20	4.5-12.0	●		●							
	ANHX110604R-M	0.08-0.15	3.0-9.0	●		●							
	110608R-M	0.08-0.15	3.0-9.0	●		●	●	●	●	●	●		
	110616R-M	0.08-0.15	3.0-9.0	●		●					●		
	160704R-M	0.10-0.20	4.5-12.0	●	●	●			●	●	●	●	
	160708R-M	0.10-0.20	4.5-12.0	●	●	●	●	●	●	●	●	●	
	160716R-M	0.10-0.20	4.5-12.0	●		●			●	●	●	●	
160724R-M	0.10-0.20	4.5-12.0	●		●	●	●	●	●	●	●		
	ANHX160708R-ML	0.06-0.12	4.5-12.0			●	●	●					
	ANHX160708R-MR	0.13-0.25	4.5-12.0			●		●			●		
	ANHX110604R-AL	0.10-0.40	3.0-9.0										●
	110608R-AL	0.10-0.40	3.0-9.0										●
	160704R-AL	0.10-0.40	4.5-12.0										●
	160708R-AL	0.10-0.40	4.5-12.0										●
	ANHX110608R-SM	0.08-0.15	3.0-9.0	●		●		●			●		
	160708R-SM	0.10-0.20	4.5-12.0	●		●		●			●		
	ANHX110608R-SML	0.06-0.15	3.0-9.5	●					●				
	160708R-SML	0.06-0.20	4.5-13.5	●		●							

● Стандартное наименование



Пластина

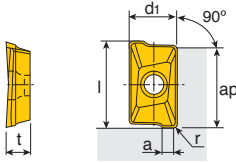

Габарит	Размеры (мм)					
	l	d ₁	t	ap	a	r
09	9.7-10.6	6.20	3.8	8.8	0.5-1.79	0.4-3.2
09 T3 PER	10.5	6.20	3.8	8.8	0.5-1.79	0.4



Пластина	Обозначение	Рекомендованные режимы резания		Керамика								Покрытие		Без покрытия	
		Подача (мм/зуб)	ap (мм)	CT7000	TT9080	TT9030	TT8080	TT8020	TT7800	TT7080	TT7515	TT6080	TT2510	K10	
	APKT 09T3 PER-EM	0.05-0.10	2.5-7.5	●	●	●	●	●	●	●	●	●	●	●	
	09T305R-EM	0.05-0.10	2.5-7.5					●							
	09T308R-EM	0.05-0.10	2.5-7.5		●	●	●	●		●	●	●	●		
	09T316R-EM	0.05-0.10	2.5-7.5		●	●	●	●		●		●	●		
	09T320R-EM	0.05-0.10	2.5-7.5		●		●						●		
	09T332R-EM	0.05-0.10	2.5-7.5		●		●						●		
	09T3 PER-M	0.05-0.10	2.5-7.5					●		●		●	●		
	APCT 09T3 PER-ML	0.05-0.10	3.0-7.5	●	●		●	●		●		●			
	APCT 09T3 PER-AL	0.05-0.35	2.5-7.5										●		

●: Стандартное наименование

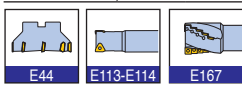

Пластина

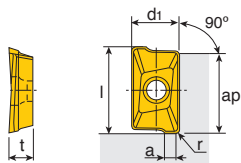

Габарит	Размеры (мм)					
	l	d1	t	ap	a	r
12	13.0-14.6	8.3	4.5-4.9	11.8-12.5	0.9-2.1	0.4-4.0
1204 PER	13.4-14.6	8.3	4.5-4.9	11.8-12.5	0.9-2.1	0.8

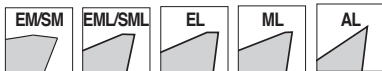

Пластина	Обозначение	Рекомендованные режимы резания		Покрытие							Без покрытия		
		Подача (мм/зуб)	ap (мм)	TT9080	TT9030	TT8080	TT8020	TT7800	TT7080	TT7515	TT6080	TT2510	K10
	APKT 1204 PER-EM	0.07-0.14	3.5-10.0	●	●	●	●	●	●	●	●		
	120404R-EM	0.07-0.14	3.5-10.0		●		●		●		●		
	120416R-EM	0.07-0.14	3.5-10.0	●	●	●	●	●	●	●	●		
	120424R-EM	0.07-0.14	3.5-10.0		●	●	●		●		●		
	120430R-EM	0.07-0.14	3.5-10.0	●	●	●	●	●	●	●	●		
	120432R-EM	0.07-0.14	3.5-10.0	●	●	●		●	●	●	●		
	120440R-EM	0.07-0.14	3.5-10.0	●		●			●		●		
	APKT 1204 PER-SM	0.07-0.14	3.5-10.0	●		●		●			●		
	APKT 1204 PER-SML	0.06-0.14	3.5-10.5	●		●							
	APKT 1204 PER-EML	0.04-0.08	3.5-10.0	●		●							
	APKT 1204 PER-EL	0.03-0.05	3.5-10.0	●	●	●	●						
	120430R-EL	0.03-0.06	3.5-10.0	●		●							
	APKT 120430R-ML	0.04-0.08	3.5-10.0	●		●							
	120432R-ML	0.04-0.08	3.5-10.0	●		●							
	120440R-ML	0.04-0.08	3.5-9.5	●		●							
	APKT 1204 PER-AL	0.10-0.50	3.5-10.0										●
	120404R-AL	0.10-0.50	3.5-10.0										●
	120416R-AL	0.10-0.50	3.5-10.0										●

●: Стандартное наименование

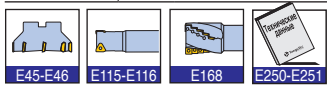

Пластина

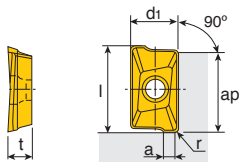

Габарит	Размеры (мм)					
	l	d1	t	ap	a	r
17	16.8–18.5	10.7	5.56	16.1	0.9-3.17	0.4-6.4
17(AL)	17.6	10.7	5.27	16.1	3.15	0.8
1705 PER	18.5-18.9	10.7	5.56-6.5	16-16.4	0.9-3.17	0.8



Пластина	Обозначение	Рекомендованные режимы резания		Покрытие								Без покрытия		
		Подача (мм/зуб)	ap (мм)	TT9080	TT9030	TT8080	TT8020	TT7800	TT7080	TT7515	TT6080	TT2510	K10	
	APKT 1705 PER-EM	0.09-0.18	4.5-13.0	●	●	●	●	●	●	●	●	●	●	●
	170504R-EM	0.09-0.18	4.5-13.0	●		●		●		●		●		
	170510R-EM	0.09-0.17	4.5-13.0	●	●			●		●		●		
	170516R-EM	0.09-0.17	4.5-13.0	●	●	●	●		●		●	●		
	170524R-EM	0.09-0.17	4.5-13.0	●	●	●	●	●	●		●	●		
	170530R-EM	0.09-0.17	4.5-13.0	●	●	●	●		●		●			
	170532R-EM	0.09-0.17	4.5-13.0	●	●	●	●	●	●		●	●		
	170535R-EM	0.09-0.17	4.5-13.0	●	●	●					●	●		
	170540R-EM	0.10-0.20	4.5-13.0	●	●		●					●		
	170548R-EM	0.09-0.17	4.5-13.0	●	●	●	●	●	●		●	●		
	170550R-EM	0.10-0.20	4.5-13.0		●		●				●	●		
170564R-EM	0.09-0.18	4.5-13.0	●	●	●	●		●		●	●			
	APKT 1706 PER-EM	0.09-0.18	4.5-13.0	●	●	●	●	●	●	●	●	●		
	APKT 1705 PER-M	0.09-0.18	4.5-13.0					●		●	●		●	
	170516R-M	0.15-0.30	4.5-13.0				●			●	●			
	170532R-M	0.10-0.20	4.5-13.0				●		●	●	●			
	170548R-M	0.10-0.20	4.5-13.0				●							
	APKT 1705 PER-SM	0.09-0.17	4.5-13.0	●		●		●			●			
	APKT 1705 PER-SML	0.06-0.17	4.5-14.5	●		●								
	APKT 1705 PER-EML	0.07-0.14	4.5-13.0	●		●			●					
	APKT 1705 PER-EL	0.05-0.10	4.5-13.0	●	●	●	●	●						
	APKT 1705 PER-AL	0.10-0.50	4.5-13.0										●	

● Стандартное наименование



Пластина

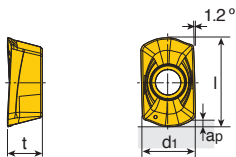

Габарит	Размеры (мм)					
	l	d ₁	t	ap		
06	6.7	4.04	2.6	0.5		
09	10.7	5.94	3.9	1.0		
12	14.2	8.0	5.0	1.2		

Пластина	Обозначение	Рекомендованные режимы резания		Покрытие							Без покрытия			
		Подача (мм/зуб)	ap (мм)	TT9080	TT9030	TT8080	TT8020	TT7800	TT7080	TT7515	TT6080	TT2510	K10	
	AXMT 0602R-HF	0.30-0.70	0.2-0.5	●		●						●		
	APKT 09T3R-HF	0.30-0.80	0.1-1.0	●		●						●		
	1204R-HF	0.10-0.80	0.2-1.0	●		●						●		



● Стандартное наименование

AXMT 06/AXCT 06

Пластина

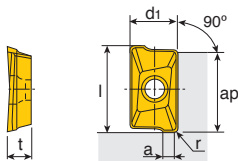

Габарит	Размеры (мм)					
	l	d ₁	t	ap	a	r
06	6.7	4.20	2.6	5.5	0.83-1.0	0.2-2.0
06 PER	6.7	4.15	2.6	5.5	0.83-1.0	0.2



Пластина	Обозначение	Рекомендованные режимы резания		Покрытие							Без покрытия			
		Подача (мм/зуб)	ap (мм)	TT9080	TT9030	TT8080	TT8020	TT7800	TT7080	TT7515	TT6080	TT2510	K10	
	AXMT 0602 PER-EM	0.04-0.08	1.5-5.0	●	●	●						●		
	060204R-EM	0.07-0.13	1.5-5.0	●	●	●	●			●	●	●		
	060208R-EM	0.07-0.13	1.5-5.0	●	●	●	●			●	●	●		
	060216R-EM	0.07-0.13	1.5-5.0	●	●	●	●					●		
	060220R-EM	0.07-0.13	1.5-5.0	●		●								
	AXCT 060202R-AL	0.10-0.20	1.5-5.0										●	
	060204R-AL	0.10-0.20	1.5-5.0										●	
	060208R-AL	0.10-0.20	1.5-5.0										●	



● Стандартное наименование

Пластина

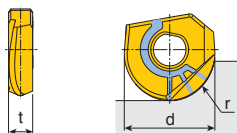

Габарит	Размеры (мм)				
	d	t	r		
080	8	2.2	4.0		
100	10	2.7	5.0		
120	12	3.2	6.0		
160	16	4.2	8.0		
200	20	5.2	10.0		
250	25	6.2	12.5		
300	30	7.2	15.0		
320	32	7.2	16.0		

Пластина	Обозначение	Рекомендованные режимы резания		Покрытие						Без покрытия				
		Подача (мм/зуб)	ap (мм)	TT9080	TT8080	TT7800	TT7080	TT7515	TT6080	TT5525	TT5515	TT2510	K10	
 Straight cutting edge	NFB 080-FM	0.05-0.20	0.05-0.3						●	●				
	100-FM	0.05-0.20	0.05-0.3						●	●				
	120-FM	0.08-0.30	0.05-0.5						●	●				
	160-FM	0.08-0.30	0.05-0.5						●	●				
	200-FM	0.08-0.30	0.10-1.0						●	●				
	250-FM	0.08-0.40	0.15-1.0						●	●				
	300-FM	0.08-0.40	0.15-1.0						●	●				
	320-FM	0.08-0.40	0.15-1.0						●	●				
 Helical cutting edge	NFB 080-SM	0.05-0.25	1.20-3.2						●	●	●			
	100-SM	0.05-0.25	1.50-4.0						●	●	●			
	120-SM	0.08-0.35	1.80-4.8						●	●	●			
	160-SM	0.08-0.35	2.40-6.4						●	●	●			
	200-SM	0.08-0.35	3.00-8.0						●	●	●			
	250-SM	0.08-0.45	3.75-10.0						●	●	●			
	300-SM	0.08-0.45	4.50-12.0						●	●	●			
	320-SM	0.08-0.45	4.80-12.8						●	●	●			

● Стандартное наименование



Пластина

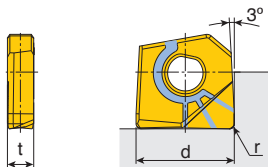

Габарит	Размеры (мм)				
	d	t	r		
080	8	2.2	0.3-1.0		
100	10	2.7	0.3-2.0		
110	11	2.7	0.3-2.0		
120	12	3.2	0.3-2.0		
130	13	3.2	0.3-2.0		
160	16	4.2	0.3-3.0		
170	17	4.2	1.0-2.0		

Пластина	Обозначение	Рекомендованные режимы резания		Покрытие								Без покрытия		
		Подача (мм/зуб)	ap (мм)	TT9080	TT8080	TT7800	TT7080	TT7515	TT6080	TT5525	TT5515	TT2510	K10	
	NFR 080A-R03	0.05-0.12	0.05-0.2							●	●	●		
	080A-R05	0.05-0.12	0.05-0.2							●	●	●		
	080A-R06	0.05-0.12	0.05-0.2							●	●	●		
	080A-R10	0.05-0.12	0.05-0.2							●	●	●		
	100A-R03	0.05-0.12	0.05-0.3							●	●	●		
	100A-R05	0.05-0.12	0.05-0.3							●	●	●		
	100A-R08	0.05-0.12	0.05-0.3							●	●	●		
	100A-R10	0.05-0.12	0.05-0.3							●	●	●		
	100A-R15	0.05-0.12	0.05-0.3							●	●	●		
	100A-R20	0.05-0.12	0.05-0.3							●	●	●		
	110A-R10	0.05-0.12	0.05-0.3							●	●	●		
	110A-R20	0.05-0.12	0.05-0.3							●	●	●		
	120A-R03	0.08-0.15	0.07-0.3							●	●	●		
	120A-R05	0.08-0.15	0.07-0.3							●	●	●		
	120A-R10	0.08-0.15	0.07-0.3							●	●	●		
	120A-R15	0.08-0.15	0.07-0.3							●	●	●		
	120A-R20	0.08-0.15	0.07-0.3							●	●	●		
	130A-R10	0.08-0.15	0.07-0.3							●	●	●		
	130A-R20	0.08-0.15	0.07-0.3							●	●	●		
	160A-R03	0.08-0.15	0.08-0.5							●	●	●		
	160A-R05	0.08-0.15	0.08-0.5							●	●	●		
	160A-R10	0.08-0.15	0.08-0.5							●	●	●		
	160A-R13	0.08-0.15	0.08-0.5							●	●	●		
	160A-R15	0.08-0.15	0.08-0.5							●	●	●		
	160A-R20	0.08-0.15	0.08-0.5							●	●	●		
	160A-R30	0.08-0.15	0.08-0.5							●	●	●		
	170A-R10	0.08-0.15	0.08-0.5							●	●	●		
	170A-R20	0.08-0.15	0.08-0.5							●	●	●		

● - Стандартное наименование



Пластина

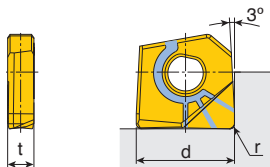

Габарит	Размеры (мм)				
	d	t	r		
200	20	5.2	0.3-3.0		
210	21	5.2	1.0-2.0		
250	25	6.2	0.3-3.0		
260	26	6.2	1.0-2.0		
300	30	7.1	1.0-2.0		
320	32	7.1	1.0-2.0		

Пластина	Обозначение	Рекомендованные режимы резания		Покрyтие						Без покрyтия			
		Подача (мм/зуб)	ap (мм)	TT9080	TT8080	TT7800	TT7080	TT7515	TT6080	TT5525	TT5515	TT2510	K10
	NFR 200A-R03	0.08-0.15	0.1-0.7						●	●	●		
	200A-R05	0.08-0.15	0.1-0.7						●	●	●		
	200A-R10	0.08-0.15	0.1-0.7						●	●	●		
	200A-R15	0.08-0.15	0.1-0.7						●	●	●		
	200A-R16	0.08-0.15	0.1-0.7						●	●	●		
	200A-R20	0.08-0.15	0.1-0.7						●	●	●		
	200A-R30	0.08-0.15	0.1-0.7						●	●	●		
	210A-R10	0.08-0.15	0.1-0.7						●	●	●		
	210A-R20	0.08-0.15	0.1-0.7						●	●	●		
	250A-R03	0.08-0.15	0.1-1.0						●	●	●		
	250A-R05	0.08-0.15	0.1-1.0						●	●	●		
	250A-R10	0.08-0.15	0.1-1.0						●	●	●		
	250A-R15	0.08-0.15	0.1-1.0						●	●	●		
	250A-R20	0.08-0.15	0.1-1.0						●	●	●		
	250A-R30	0.08-0.15	0.1-1.0						●	●	●		
	260A-R10	0.08-0.15	0.1-1.0						●	●	●		
	260A-R20	0.08-0.15	0.1-1.0						●	●	●		
	300A-R05	0.08-0.20	0.1-1.0						●	●	●		
	300A-R10	0.08-0.20	0.1-1.0						●	●	●		
	300A-R20	0.08-0.20	0.1-1.0						●	●	●		
320A-R10	0.08-0.20	0.1-1.0						●	●	●			
320A-R20	0.08-0.20	0.1-1.0						●	●	●			

● Стандартное наименование



Пластина

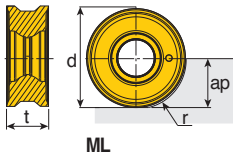

ML

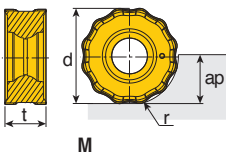

M

Габарит	Размеры (мм)						
	r	d	t	ap			
10	5	10	4.5	5			
12	6	12	5.0	6			
16	8	16	6.3	8			



Пластина	Обозначение	Рекомендованные режимы резания		Покрытие							Без покрытия			
		Подача (мм/зуб)	ap (мм)	TT9080	TT9030	TT8080	TT8020	TT7800	TT7080	TT7515	TT6080	TT2510	K10	
	RNMU 1004-ML	0.05-0.30	1.5-4.0	●	●	●	●					●		
	1205-ML	0.05-0.35	1.5-5.0	●	●	●	●					●		
	1606-ML	0.05-0.40	2.0-6.5	●	●	●	●					●		
	RNMU 1004S-M	0.05-0.35	1.5-4.0	●	●	●	●					●		
	1205S-M	0.05-0.40	1.5-5.0	●	●	●	●					●		
	1606S-M	0.05-0.45	2.0-6.5	●	●	●	●					●		

● Стандартное наименование



RP(N)GX 12

Пластина

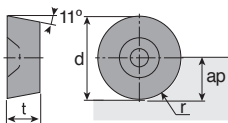

RP GX

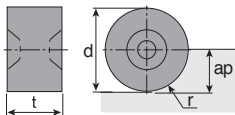

RN GX

Габарит	Размеры (мм)						
	r	d	t	ap			
RP GX 12	6.35	12.7	4.76	6			
RN GX 12	6.35	12.7	7.94	6			

Пластина	Обозначение	Рекомендованные режимы резания		Покрытие							Без покрытия			
		Подача (мм/зуб)	ap (мм)	Керамика AS20	TT9080	TT9030	TT8080	TT8020	TT7800	TT7080	TT7515	TT6080	K10	
	RP GX 1204-CH	0.10-0.20	1.5-5.0	●										
	RN GX 1207-CH	0.10-0.20	1.5-5.0	●										

● Стандартное наименование



Пластина

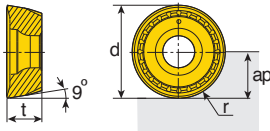

Габарит	Размеры (мм)						
	r	d	t	ap			
08	4	8	3.2	4			
10	5	10	4.0	5			
12	6	12	4.8	6			
16	8	16	6.1	8			
20	10	20	7.0	10			



Пластина	Обозначение	Рекомендованные режимы резания		Покрытие								Без покрытия		
		Подача (мм/зуб)	ap (мм)	TT9080	TT9030	TT8080	TT8020	TT7800	TT7080	TT7515	TT6080	TT2510	K10	
	RYMX 0803-M	0.05-0.25	1.0-3.5	●	●	●	●	●	●	●	●			
	1004-M	0.10-0.30	1.5-4.0	●	●	●	●	●	●	●	●			
	1205-M	0.10-0.50	1.5-5.0	●	●	●	●	●	●	●	●			
	1205-6M	0.10-0.50	1.5-5.0	●				●			●			
	1606-M	0.10-0.50	2.0-6.5	●	●	●	●	●	●	●	●			
	1606-7M	0.10-0.50	2.0-6.5	●				●			●			
	2007-M	0.10-0.50	3.0-8.0	●	●	●	●	●	●	●	●			
	RYMX 0803-MM	0.07-0.30	1.0-3.5	●	●	●								
	1004-MM	0.07-0.35	1.5-4.0	●	●	●								
	1205-MM	0.10-0.40	1.5-5.0	●	●	●	●							
	1205-6MM	0.10-0.40	1.5-5.0	●										
	1606-MM	0.10-0.45	2.0-6.5	●	●	●								
	1606-7MM	0.10-0.45	2.0-6.5	●	●	●								
	1205-MM	0.10-0.40	3.0-8.0	●			●							
	RYMX 0803-ML	0.05-0.25	1.0-3.5	●	●	●	●							
	1004-ML	0.05-0.30	1.5-4.0	●	●	●	●							
	1205-ML	0.05-0.35	1.5-5.0	●	●	●	●							
	1205-6ML	0.05-0.35	1.5-5.0	●	●									
	1606-ML	0.05-0.40	2.0-6.5	●	●	●	●							
	1606-7ML	0.05-0.40	2.0-6.5	●	●	●								
	2007-ML	0.10-0.50	3.0-8.0	●	●	●	●	●	●	●				
	RYHX 0803-ML	0.05-0.25	1.0-3.5	●	●	●								
	1004-ML	0.05-0.30	1.5-4.0		●	●								
	1205-ML	0.05-0.35	1.5-5.0	●	●	●								
1606-ML	0.10-0.40	2.0-6.5	●	●	●									

●: Стандартное наименование

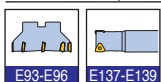

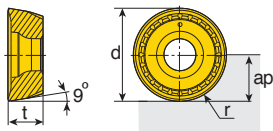

Пластина



Габарит	Размеры (мм)				
	r	d	t	ap	
08	4	8	3.2	4	
10	5	10	4.0	5	
12	6	12	4.8	6	
16	8	16	6.1	8	
20	10	20	7.0	10	



Пластина	Обозначение	Рекомендованные режимы резания		Покрытие							Без покрытия			
		Подача (мм/зуб)	ap (мм)	TT9080	TT9030	TT8080	TT8020	TT7800	TT7080	TT7515	TT6080	TT2510	K10	
	RYMX 0803-MR	0.05-0.30	1.0-3.5	●				●	●	●	●	●		
	1004-MR	0.05-0.35	1.5-4.0	●				●	●	●	●	●		
	1205-MR	0.05-0.35	1.5-5.0			●			●	●	●	●		
	1606-MR	0.05-0.40	2.0-6.5	●				●	●	●	●	●		
	2007-MR	0.10-0.45	1.0-3.5	●				●		●	●	●		
RYHX	0803-MR	0.05-0.30	1.5-4.0	●						●	●	●		
	1004-MR	0.05-0.35	1.5-5.0	●						●	●	●		
	1205-MR	0.05-0.35	2.0-6.5	●						●	●	●		
	RYHX 0803-AL	0.10-0.80	1.0-3.5										●	
	1004-AL	0.10-0.80	1.5-4.0										●	
	1205-AL	0.10-0.80	1.5-5.0										●	
	1606-AL	0.10-0.80	2.0-6.5										●	

● Стандартное наименование



Пластина

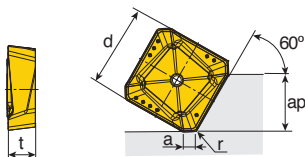

Габарит	Размеры (мм)					
	d	t	ap	a	r	
21-HE	20.8	7	13	2	1.5	
21-HS	21	6.95	13	2	1.5	
27-HE	26.8	8.95	18	2	2	
27-HS	27	8.9	18	2	2	

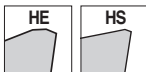

Пластина	Обозначение	Рекомендованные режимы резания		Покрытие								Без покрытия			
		Подача (мм/зуб)	ap (мм)	TT9080	TT9030	TT8080	TT8020	TT7800	TT7080	TT7515	TT6080			K10	
	SCKN 2107 DDTR-HE	0.13-0.25	3.5-10.5					●	●	●					
	2708 DDTR-HE	0.15-0.30	5.0-14.5					●	●						
	SCKN 2107 DDTR-HS	0.13-0.25	3.5-10.5					●							
	2708 DDTR-HS	0.13-0.25	5.0-14.5					●							



● Стандартное наименование

SDKN 12/15

Пластина

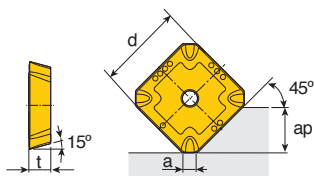

Габарит	Размеры (мм)					
	d	t	ap	a	r	
12	12.7	3.18	6.5	2.00		
15	15.875	4.76	8.7	1.89		

Пластина	Обозначение	Рекомендованные режимы резания		Покрытие								Без покрытия			
		Подача (мм/зуб)	ap (мм)	TT9080	TT9030	TT8080	TT8020	TT7800	TT7080	TT7515	TT6080			K10	
	SDKN 1203 MT-HPN	0.10-0.25	1.5-6.0						●						
	1504 MT-HPN	0.10-0.25	1.5-8.0						●						
	SDKN 1203 MT-GPN	0.10-0.25	1.5-6.0						●						
	1504 MT-GPN	0.10-0.25	1.5-8.0						●						



● Стандартное наименование

Пластина

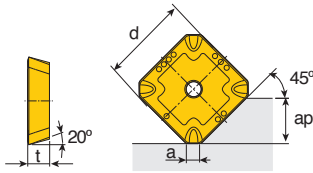

Габарит	Размеры (мм)				
	d	t	ap	a	
12	12.7	3.18	6.5	2.08	
15	15.875	4.76	8.7	2.06	

Пластина	Обозначение	Рекомендованные режимы резания		Покрытие						Без покрытия			
		Подача (мм/зуб)	ap (мм)	TT9080	TT9030	TT8080	TT8020	TT7800	TT7080	TT7515	TT6080	K10	
	SEKN 1203 AFTN-HPN	0.10-0.25	1.5-6.0					●					
	1504 AFTN-HPN	0.10-0.25	1.5-8.0					●					
	SEKN 1203 AFTN-GPN	0.10-0.25	1.5-6.0					●					
	1504 AFTN-GPN	0.10-0.25	1.5-8.0					●					



●: Стандартное наименование

SEKX 21

Пластина

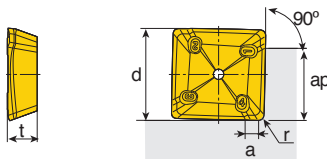

Габарит	Размеры (мм)				
	d	t	ap	a	r
21 PETR-M	21.85	7	17	2	1.2

Пластина	Обозначение	Рекомендованные режимы резания		Покрытие						Без покрытия		
		Подача (мм/зуб)	ap (мм)	TT9080	TT9030	TT8080	TT8020	TT7800	TT7080	TT7515	TT6080	K10
	SEKX 2107 PETR-M	0.10-0.22	5.5-13.0					●		●		



●: Стандартное наименование

Пластина

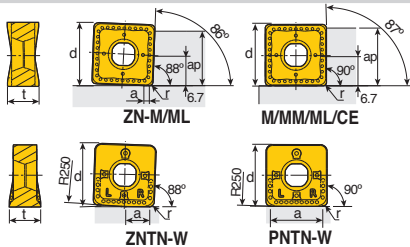

Габарит	Размеры (мм)				
	d	t	ap	a	r
13	13.5	6.8-7.0	10-12	1.2-5.3	0.4-1.6
13-W	13.5	6.8	10-12	11.5	1.0

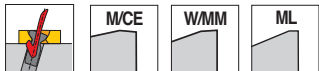

Пластина	Обозначение	Рекомендованные режимы резания		Керамика	Покрытие							Без покрытия		
		Подача (мм/зуб)	ap (мм)		AS10	TT9080	TT9030	TT8080	TT7800	TT7080	TT7515	TT6080	TT2510	K10
	SNGX 1306 ZN-M	0.10-0.20	3.5-10.0		●	●	●	●	●					
	SNGX 1306 ZN-ML	0.13-0.25	3.5-10.0		●	●			●	●				
	1306C08 ZN-M	0.10-0.20	3.5-10.0		●				●	●	●			
	130608-MM	0.08-0.15	3.5-10.0				●							
	130612-MM	0.08-0.15	3.5-10.0						●					
	130616-MM	0.08-0.15	3.5-10.0				●		●					
	130608-ML	0.13-0.25	3.5-10.0							●				
	130612-ML	0.13-0.25	3.5-10.0							●				
	SNGX 130608-M	0.10-0.20	3.5-10.0		●				●	●	●	●		
	130612-M	0.10-0.20	3.5-10.0		●		●		●	●	●			
	130616-M	0.10-0.20	3.5-10.0		●		●	●	●	●	●			
	130620-M	0.10-0.20	3.5-10.0		●				●	●	●			
	SNGX 130608-CE	0.13-0.25	3.5-10.0	●										
	SNGX 1306 ZNTN-W	0.10-0.20	0.2-1.0		●						●			
	SNGX 1306 PNTN-W	0.10-0.20	0.2-1.0		●						●			

●: Стандартное наименование



Пластина

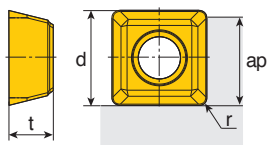

Габарит	Размеры (мм)						
	d	t	ap	r			
06	6.16	2.56	5.6	0.4			
09	9.8	4.3	9.0	0.8			
11	11.5	4.8	10.7	0.8			
14	14.2	5.2	13.4	0.8			



Пластина	Обозначение	Рекомендованные режимы резания		Кермет	Покрытие								Без покрытия	
		Подача (мм/зуб)	ap (мм)		CT7000	TT9080	TT9030	TT8080	TT8020	TT7800	TT7080	TT7515	TT6080	K10
	SPMG 09040-EM	0.08-0.15	2.5-7.5					●						
	09040-EM	0.08-0.15	2.5-7.5		●			●			●			
	11040-EM	0.09-0.16	3.0-8.5		●	●	●	●			●			
	14050-EM	0.10-0.18	4.0-11.0		●		●	●			●			
	SPMT 09040-EM	0.08-0.15	2.5-7.5		●	●		●			●	●	●	
	11040-EM	0.09-0.16	3.0-8.5		●	●	●	●			●	●	●	
	14050-EM	0.10-0.18	4.0-11.0		●		●	●	●		●		●	
	XOMT 060204	0.03-0.06	1.5-4.5			●		●						

● Стандартное наименование

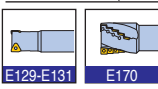

TIPV

Пластина отрезная

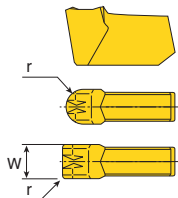

Габарит	Размеры (мм)		
	Seat size	W±0.1	r
TIPV..E ...	4	3.0-4.5	0.4-2.0
TIPV 1.85-2.15	2	1.85-2.15	0.1-0.2
TIPV 2.65-4.15	4	2.65-4.15	0.15-0.20

Пластина	Обозначение	Рекомендованные режимы резания		Покрытие								Без покрытия	
		Подача (мм/зуб)	ap (мм)	TT9080	TT9030	TT8080	TT8020	TT7220	TT7080	TT6030	TT5100	K10	
	TIPV 3.00E 0.40	0.06-0.18	-							●	●	●	
	4.00E 0.40	0.08-0.20	-							●	●	●	
	4.50E 0.40	0.08-0.20	-							●	●	●	
	3.00E 1.50	0.06-0.18	-							●	●		
	4.00E 2.00	0.08-0.20	-							●	●		
	1.85 0.10	0.05-0.13	-							●	●		
	2.00 0.20	0.05-0.13	-							●	●		
	2.15 0.15	0.05-0.13	-							●	●		
	2.65 0.15	0.06-0.18	-								●		
	3.00 0.20	0.06-0.18	-							●	●		
	3.18 0.20	0.06-0.18	-							●	●		
	4.00 0.20	0.08-0.20	-							●	●		
	4.15 0.15	0.08-0.20	-							●	●		

●: Стандартное наименование



Пластина

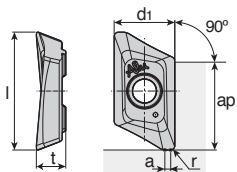

Габарит	Размеры (мм)					
	l	d ₁	t	ap	a	r
16	18.3-22.2	11.2	5.1-5.5	14-16	0.6-1.5	0.4-5.0
22	22.4-28	13.6	6.8-7.4	18.5-21	1.2-1.7	0.5-6.4

Пластина	Обозначение	Рекомендованные режимы резания		Покрытие								Без покрытия			
		Подача (мм/зуб)	ap (мм)	TT9080	TT9030	TT8080	TT8020	TT7800	TT7080	TT7515	TT6080	K10			
	XEVT 160504R-AL	0.1-0.4	3.5-12.0										●		
	160508R-AL	0.1-0.4	3.5-12.0										●		
	160512R-AL	0.1-0.4	3.5-12.0										●		
	160516R-AL	0.1-0.4	3.5-12.0										●		
	160520R-AL	0.1-0.4	3.5-12.0										●		
	160524R-AL	0.1-0.4	3.5-12.0										●		
	160530R-AL	0.1-0.4	3.5-12.0										●		
	160532R-AL	0.1-0.4	3.5-12.0										●		
	160540R-AL	0.1-0.4	3.5-12.0										●		
	160550R-AL	0.1-0.4	3.5-12.0										●		
	220605R-AL	0.1-0.6	3.5-18.0										●		
	220608R-AL	0.1-0.6	3.5-18.0										●		
	220616R-AL	0.1-0.6	3.5-18.0										●		
	220620R-AL	0.1-0.6	3.5-18.0										●		
	220630R-AL	0.1-0.6	3.5-18.0										●		
	220640R-AL	0.1-0.6	3.5-18.0										●		
	220650R-AL	0.1-0.6	3.5-18.0										●		
	220664R-AL	0.1-0.6	3.5-18.0										●		

●: Стандартное наименование

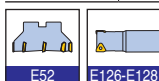

Пластина

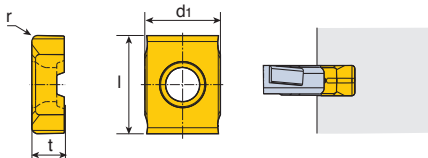

Габарит	Размеры (мм)				
	l	d1	t	r	
018	10	7.5	1.8	0.2-0.8	
023	10	7.5	2.3	0.2-0.8	
028	10	7.5	2.8	0.2-0.8	
033	10	7.5	3.3	0.2-0.8	
038	13	10	3.8	0.4-0.8	
043	13	10	4.3	0.4-0.8	
048	13	10	4.8	0.4-0.8	
053	13	10	5.3	0.4-0.8	



Пластина	Обозначение	Рекомендованные режимы резания		Покрытие								Без покрытия	
		Подача (мм/зуб)	ap (мм)	TT9080	TT9030	TT8080	TT8020	TT7800	TT7080	TT7515	TT6080	K10	
	ZNHT 018-04	0.05-0.08	-	●		●		●	●		●		
	018-08	0.05-0.08	-	●		●							
	023-04	0.05-0.08	-			●		●	●		●		
	023-08	0.05-0.08	-	●		●							
	028-04	0.05-0.10	-	●		●		●	●		●		
	028-08	0.05-0.10	-	●		●							
	033-04	0.05-0.12	-	●		●		●	●		●		
	033-08	0.05-0.12	-	●		●		●					
	038-04	0.05-0.12	-			●					●		
	038-08	0.05-0.12	-	●		●		●	●		●		
	043-04	0.05-0.15	-	●		●		●	●		●		
	043-08	0.05-0.15	-	●		●		●	●		●		
	048-04	0.05-0.15	-	●		●		●	●		●		
	048-08	0.05-0.15	-	●		●		●	●		●		
	053-04	0.05-0.15	-	●		●		●	●		●		
053-08	0.05-0.15	-	●		●		●	●		●			
	ZNHT 018-04-ML	0.05-0.08	-			●				●			
	023-04-ML	0.05-0.08	-			●				●			
	028-04-ML	0.05-0.08	-			●				●			
	033-04-ML	0.05-0.12	-			●				●			
	038-04-ML	0.05-0.12	-			●				●			
	043-04-ML	0.05-0.12	-			●				●			
	048-04-ML	0.05-0.12	-			●				●			
	053-04-ML	0.05-0.12	-			●				●			
	ZNHT 018-02-AL	0.10-0.35	-									●	
	023-02-AL	0.10-0.35	-									●	
	028-02-AL	0.10-0.35	-									●	
	033-02-AL	0.10-0.35	-									●	
	038-04-AL	0.10-0.35	-									●	
	043-04-AL	0.10-0.35	-									●	
	048-04-AL	0.10-0.35	-									●	
	053-04-AL	0.10-0.35	-									●	
	053-08-AL	0.10-0.35	-									●	

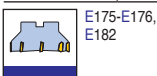

● Стандартное наименование



Рекомендуемые режимы резания

Режимы резания для сплава PCBN

ISO	D.O.C. (мм)	Материал	Сплав		
			KB90		
			Скорость резания Vc (м/мин)	Подача (мм/зуб)	Режущая кромка
P	< 2	Подшипниковая сталь	180 - 220	0.05 - 0.25	Фаска
	< 2	Черный порошковый металл	150 - 300	0.1 - 0.15	Фаска
K	< 0.5	Серый чугун HB 200 - 280	500 - 1500	0.1 - 0.3	Притупленная фаска
	0.5 - 2.0		500 - 1100	0.1 - 0.25	Фаска
	< 0.5	Металлический порошок (CGI)	400 - 600	0.1 - 0.2	Притупление
S	0.5 - 2.0	Кобальтовые > 35 HRC	150 - 200	0.05 - 0.15	Фаска
		Никелевые > 35 HRC	120 - 150	0.05 - 0.15	Фаска
		Железные > 35 HRC	60 - 120	0.05 - 0.15	Фаска
		Хромовые > 35 HRC	50 - 75	0.05 - 0.15	Фаска
H	< 0.5	Закаленные стали > 45 HRC	80 - 180	0.1 - 0.25	Фаска
	< 2	Закаленный чугун	80 - 200	0.1 - 0.15	Фаска

- Больше информации о группах материалов в Переводной таблице материалов

■ Сталь
 ■ Нержавеющая сталь
 ■ Чугун
 ■ Цветные металлы
 ■ Жаропрочные сплавы
 ■ Закаленная сталь

Рекомендуемые режимы резания

Данные по обработке

Скорость резания(м/мин)

ISO	Материал	Режим	Предел прочности (N/мм ²)	Твердость HB	Материал №	Без покрытия		
						K10	P30	
P	Нелегированная сталь, стальное литье, автоматная сталь	< 0.25%C	Отожженная	420	125	1		60-170
		>= 0.25%C	Отожженная	650	190	2		60-130
		< 0.55%C	Закалка и отпуск	850	250	3		60-100
		>= 0.55%C	Отожженная	750	220	4		60-120
			Закалка и отпуск	1000	300	5		50-100
	Низколегированная сталь и стальное литье(менее 5% легирующих элементов)	Закалка и отпуск	Отожженная	600	200	6		60-130
				930	275	7		60-100
				1000	300	8		50-100
				1200	350	9		40-90
	Высоколегированная сталь, стальное литье и инструментальная сталь	Отожженная	680	200	10		60-130	
Закалка и отпуск		1100	325	11		50-100		
M	Нержавеющая сталь и стальное литье	Ферритный/Мартенситный	680	200	12			
		Мартенситный	820	240	13			
		Аустенитный	600	180	14			
K	Серый чугун (GG)	Ферритный		160	15	70-130		
		Перлитный		250	16	50-110		
	Высокопрочный чугун (GGG)	Ферритный		180	17	45-90		
		Перлитный		260	18	40-85		
	Ковкий чугун	Ферритный		130	19	70-140		
Перлитный			230	20	55-115			
N	Алюминий - Ковкий сплав	Не структурированные		60	21	550-700		
		Структурированные		100	22	600-750		
	Алюминий - литейный сплав	<=12% Si	Не структурированные		75	23	800-900	
			Структурированные		90	24	650-800	
		>12% Si	Высокотемпературный сплав		130	25	250-320	
	Сплавы меди	>1% Pb	Легкорезущиеся		110	26	300-400	
			Бронза		90	27	300-400	
			Электролитная медь		100	28	210-280	
Неметаллические материалы	Реактопласты, волокниты				29			
	Твердая резина				30			
S	Жаропрочные сплавы	Fe based	Отожженная		200	31	50-70	
			Структурированные		280	32	40-50	
		Ni or Co based	Отожженная		250	33	50-70	
			Структурированные		350	34	35-40	
	Литье			320	35	45-50		
		Титан, титановые сплавы	Альфа и бета сплавы структурированные	Rm 400		36	120-145	
H	Закаленная сталь	Закалка		55HRC	38			
		Закалка		60HRC	39			
	Отбелённый чугун	Литье		400	40			
	Чугун с шаровидным графитом	Закалка		55HRC	41			

• Больше информации о группах материалов в Переводной таблице материалов

■ Сталь
 ■ Нержавеющая сталь
 ■ Чугун
 ■ Цветные металлы
 ■ Жаропрочные сплавы
 ■ Закаленная сталь

Исполнение посадочного места

Метрическое исполнение

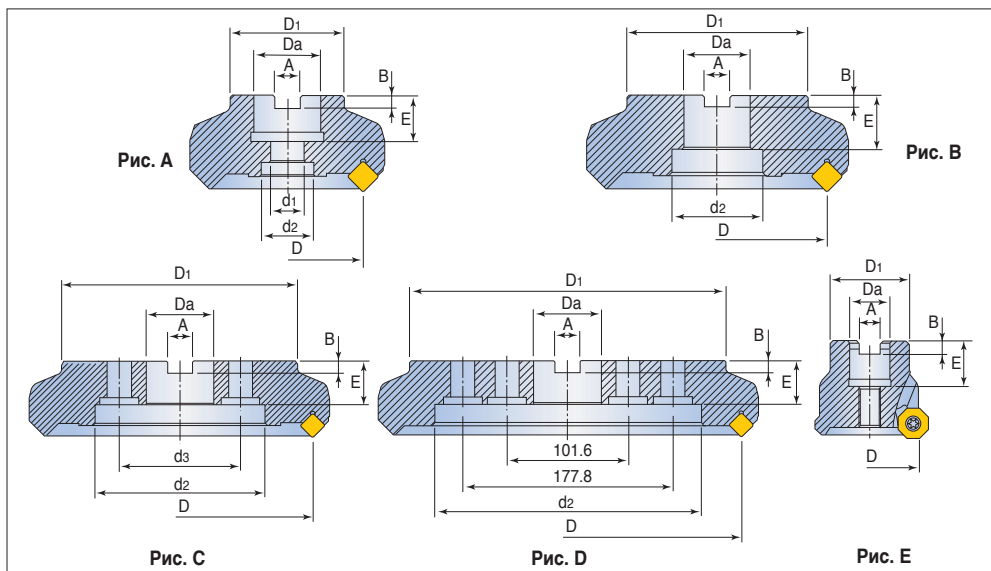

Размеры (мм)											Рис.	Оправка
D	Da	A	B	E	D1		d1	d2	d3			
					Для пресс-форм и штампов	Общее применение						
32	16	8.4	5.6	20	30	-	-	-	-	E	SEM16	
32	16	8.4	5.6	20	30	-	9	13.5	-	A	SEM16	
40	16	8.4	5.6	20	38	-	9	13.5	-	A	SEM16	
40	22	10.4	6.3	22	38	-	11	17	-	A	SEM22	
50	22	10.4	6.3	22	40	45	11	17	-	A	SEM22	
63	22	10.4	6.3	22	47	-	11	17	-	A	SEM22	
80	27	12.4	7	28	58	70	13	22	-	A	SEM27	
100	32	14.4	8	26	66	85	18	26	-	A	SEM32	
100	32	14.4	8	26	66	85	-	46	-	B	SEM32	
125	40	16.4	9	32	85	-	22	32	-	A	SEM40	
125	40	16.4	9	32	85	-	-	56	-	B	SEM40	
160	40	16.4	9	32	110	-	-	90	66.7	C	FM40	
200	60	25.7	14	40	130	-	-	132	101.6	C	FM60	
250	60	25.7	14	40	160	-	-	150	101.6	C	FM60	
315	60	25.7	14	40	220	-	-	220	-	D	-	

• Патроны для торцовых фрез приводятся на страницах раздела вспомогательного инструмента **G**

Крепежный болт

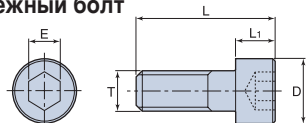

Тип SH

Обозначение	Размеры (мм)					Габарит фрезы
	D	L	L ₁	T	E	
SH M8x1.25x30(-C)	13	38	8	8	6	40
SH M10x1.5x30(-C)	16	40	10	10	8	50, 63
SH M12x1.75x35(-C)	18	47	12	12	10	80
SH M16x2x35(-C)	24	51	16	16	14	100

Тип LH

Обозначение	Размеры (мм)					Габарит фрезы
	D	L	L ₁	T	E	
LH M10x1.5x25(-C)	16	31.5	6.5	10	8	50, 63
LH M12x1.75x30(-C)	18	36.9	6.9	12	8	80
LH M16x2x35(-C)	24	45	10	16	12	100

• "-C": Болт с отверстием для подачи СОЖ

Исполнение посадочного места

Дюймовое исполнение

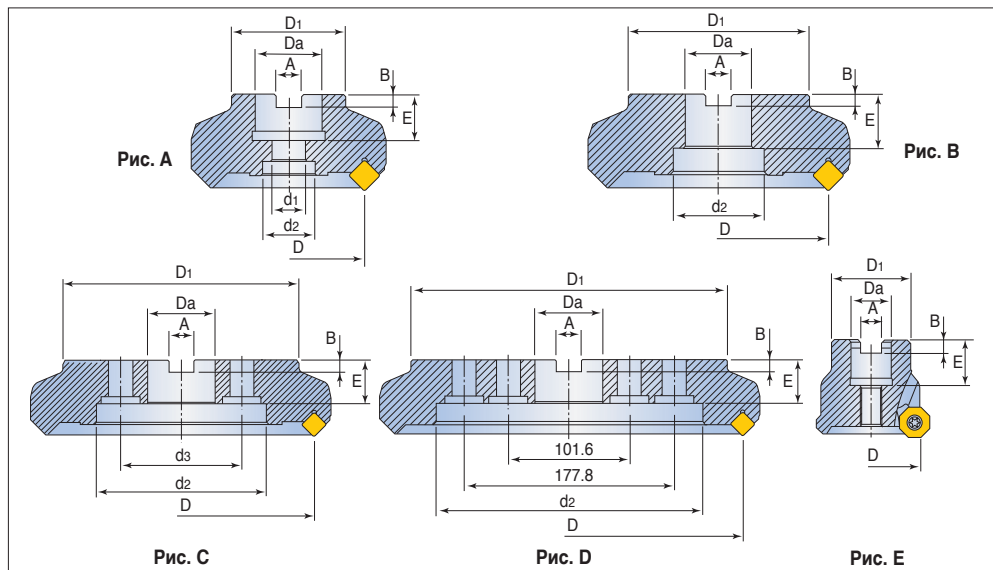

Размеры (мм)										Рис.	Оправка
D	Da	A	B	E	D1	d1	d2	d3			
32	16	8.4	5.6	20	30	-	-	-	E	SEM16	
32	16	8.4	5.6	20	30	9	13.5	-	A	SEM16	
40	16	8.4	5.6	20	38	9	13.5	-	A	SEM16	
40	22	10.4	6.3	22	38	11	17	-	A	SEM22	
50	22	10.4	6.3	22	45	11	17	-	A	SEM22	
63	22	10.4	6.3	22	47	11	17	-	A	SEM22	
80	25.4	9.526	6	26	70	13	20	-	A	FMA25.4	
100	31.75	12.7	8	32	80	18	26	-	A	FMA31.75	
100	31.75	12.7	8	32	80	-	46	-	B	FMA31.75	
125	38.1	15.875	10	38	80	-	56	-	B	FMA38.1	
160	50.8	19.05	11	38	100	-	72	-	B	FMA50.8	
200	47.625	25.4	14	38	130	-	132	101.6	C	FMA47.625	
250	47.625	25.4	14	38	160	-	150	101.6	C	FMA47.625	
315	47.625	25.4	14	38	220	-	224	-	D	-	

• Патроны для торцовых фрез приводятся на страницах раздела вспомогательного инструмента **G**

Крепежный болт

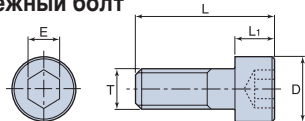

Тип SH

Обозначение	Размеры (мм)					Габарит фрезы
	D	L	L1	T	E	
SH M8x1.25x30(-C)	13	38	8	8	6	40
SH M10x1.5x30(-C)	16	40	10	10	8	50, 63
SH M12x1.75x35(-C)	18	47	12	12	10	80
SH M16x2x35(-C)	24	51	16	16	14	100

Тип LH

Обозначение	Размеры (мм)					Габарит фрезы
	D	L	L1	T	E	
LH M10x1.5x25(-C)	16	31.5	6.5	10	8	50, 63
LH M12x1.75x30(-C)	18	36.9	6.9	12	8	80
LH M16x2x35(-C)	24	45	10	16	12	100

• "-C": Болт с отверстием для подачи СОЖ

► Быстросменные фрезы

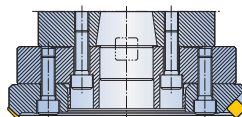
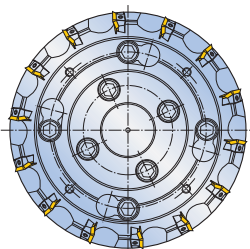

- Уменьшение веса фрезы
Если диаметр быстросменной фрезы более 200 мм, они состоят из двух частей: фрезы и переходника. Переходник крепится к шпинделю станка, а фреза крепится к переходнику. В результате вес фрезы снижается наполовину. Это позволяет уменьшить нагрузку на шпиндель и повысить безопасность работы.
- Сокращение времени простоя при замене фрезы
Время простоя при использовании быстросменных фрез сокращено на 20% по сравнению с традиционными фрезами.
- Отличное качество обработанной поверхности
Поверхность, обработанная быстросменными фрезами, отличается превосходным качеством благодаря установленным высокоточным пластинам и отсутствует торцевое биение. Возможность обработки на высоких подачах.
- Простая и жесткая конструкция
Простая конструкция крепления пластин, состоящая только из клиньев и винтов клиньев.

► Регулировочная плита

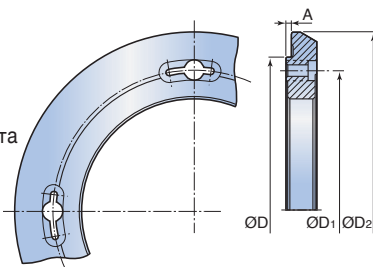
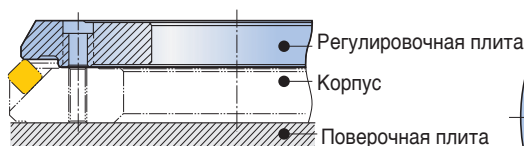

Обозначение	Размеры (мм)			
	A	D	D ₁	D ₂
SP03 - I	5.0	47	-	85
SP04 - I	5.0	60	-	105
SP05 - I	5.0	82	-	130
SP06 - I	5.0	96	-	165
SP08 - I	5.0	160	137	203
SP10 - I	5.0	210	187	253
SP12 - I	5.0	274	250	318
SP14 - I	5.0	314	290	358
SP16 - I	5.0	354	332	403

► Адаптер для быстросменной фрезы



Рис.1



Рис.2

Обозначение	Размеры (мм)							N	Вес (кг)
	D	d	d ₁	d ₂	d ₃	d ₄	M		
QA 08 K/M	198	47.625	63.5	101.6	-	114.3	M16x40	4	10
QA 10 K/M	248	60	133.35	101.6	-	177.8	M16x50	4	15
QA 12 K/M	313	60	146.05	101.6	177.8	215.9	M20x50	4	19.7
QA 14 K/M	353	60	215.9	101.6	177.8	260.4	M20x50	6	24
QA 16 K/M	398	60	254.0	101.6	177.8	304.8	M20x50	6	29

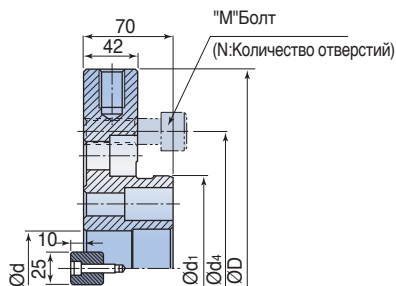
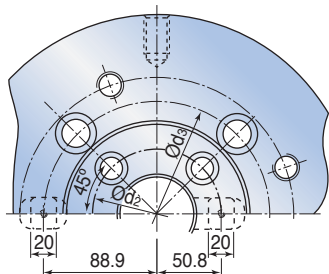
- K: Адаптер с ключем для настройки (Рис.1)
- М: Адаптер без ключа настройки (Рис.2)

► Новый тип быстросменных фрез

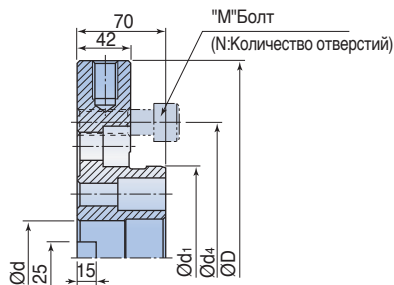
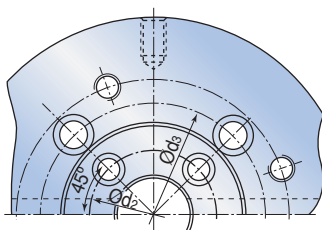
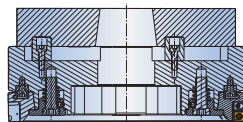
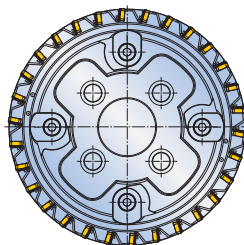

- **Небольшой вес фрезы**
Сниженный вес фрезы почти в два раза, по сравнению с обычной фрезой, обеспечивает легкую и безопасную установку инструмента.
- **Быстрая и простая система крепления**
Быстросменная и простая система с доработанной конструкцией обеспечивает сокращение времени смены инструмента.
- **Двойной контакт по двум поверхностям**
Отличная точность и повторяемость и высокой жесткостью.
- **Легкий монтаж по конусу адаптера**

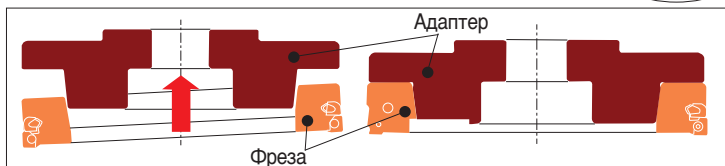
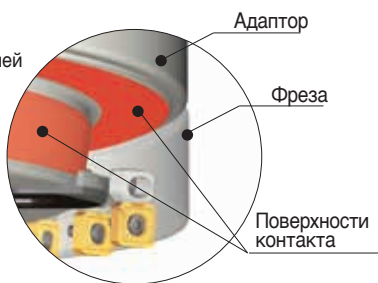

► Процесс установки

- Простой монтаж и самоцентрирование по конусу адаптера



► Новый адаптер в виде оправки

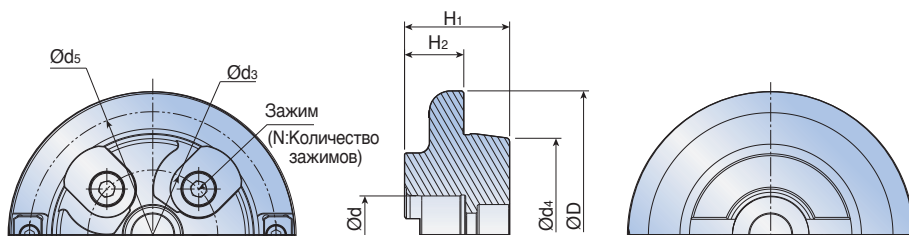

Обозначение	Размеры (мм)										Вес (кг)
	D	d	d1	d2	d3	d4	d5	N	H1	H2	
TQCA D160-FM40	150	40	-	-	68	100.37	129	4	55	31	3.9
TQCA D200-FM60	190	60	-	-	108	140.37	169	4	55	31	5.8
TQCA D250-FM60	240	60	-	-	158	190.37	219	4	55	31	10.4

► Новый адаптер для крепления на торец шпинделя

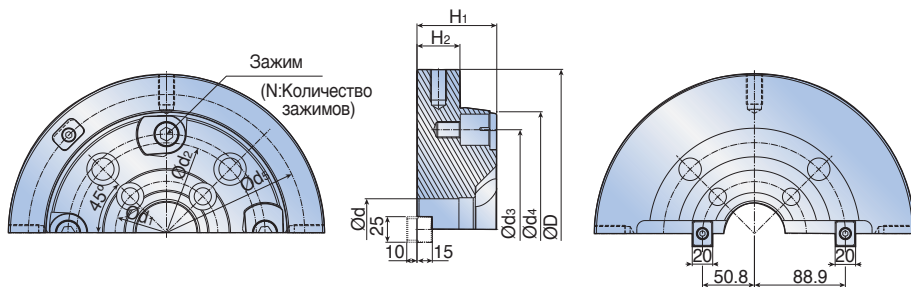

Обозначение	Размеры (мм)										Вес (кг)
	D	d	d1	d2	d3	d4	d5	N	H1	H2	
TQCA D250	248	60	101.6	-	158	190.37	219	4	72	48	17.9
TQCA D315	313	60	101.6	177.8	195	230.33	273.5	4	77	42	29.8
TQCA D355	353	60	101.6	177.8	235	270.33	313.5	8	77	42	38.3
TQCA D400	398	60	101.6	177.8	280	315.33	358.5	8	77	42	49.6

► Руководство по использованию геометрии Splitter

- 3 канавки на одной режущей кромки и 2 канавки на противоположной



APKT

ANHX

- Для простоты установки пластин на корпус одна из сторон пластины помечена темным цветом

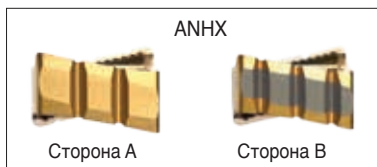
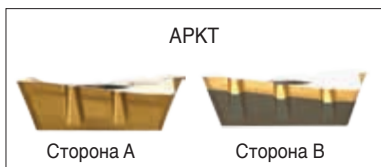

Примечание: Когда устанавливаются пластины на корпус фрезы необходимо чередовать стороны пластин. Например 1 зуб - 2 канавки, 2 зуб - 3 канавки и так далее.

- При наложении обеих сторон (А и В) геометрия Splitter дробит стружку на мелкие части, уменьшая силу резания и вибрации, при этом возможно увеличить производительность.

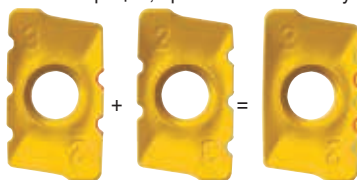

- Для лучшего эффекта, необходимо использовать корпуса фрез с четным количеством эффективных зубьев.



Сторона А Сторона В

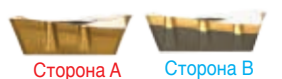

Сторона А Сторона В

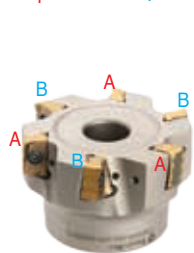

Также можно применять корпуса фрез с нечетным количеством эффективных зубьев.

- Необходимо соблюдать одно условие, глубина должна быть $\geq d1$

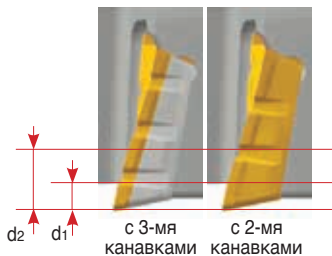

Глубина резания	АРКТ 17	АРКТ 12
d1	3мм	2.4мм
d2	6.5мм	5.2мм

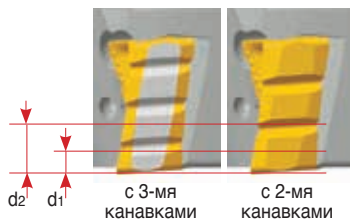

Глубина резания	АНХ 16
d1	2.5мм
d2	6мм

► Инструкция по установке

Индикатор

Пластина

Винт пластины

Регулировочный
винт

Крепежный
винт

Т-ключ



1 Переместите регулировочный клин (4) в его самое нижнее положение, вращая винт клина (5) по часовой стрелке.



※ Не прикладывайте слишком большое усилие

2 Установите пластину с новой режущей кромкой. Прежде, чем поместить пластину, убедитесь, что посадочное место полностью очищено.



※ Зафиксируйте винт пластины т.к. после фиксации регулировка не предусмотрена

3 Измерьте биение фрезы, когда все пластины будут установлены, и выберите самую высокую пластину в качестве эталона.



※ Убедитесь, что режущая кромка пластины не повреждается во время установки. Применяйте оптимальное давление поворота.

4 Установите высоту фрезы, поднимая пластину-эталон, путем проворачивания винта клина (5) против часовой стрелки.



※ Увеличьте высоту минимум на 0,01мм от самой высокой пластины

5 Отрегулируйте осевое биение остальных пластин таким же способом, как и для пластины-эталона



※ Обратите внимание, что максимальная высота регулирования не должна превышать 0,1мм (.004")

5 Отрегулируйте биение в диапазоне 0,005мм, вращая ключ постепенно.



5 Если биение вне допустимого предела, пожалуйста, повторите пункты **1** - **2** - **5**



6 Регулирование биения закончено. После того, как все винты пластин зафиксированы, нельзя их зажимать повторно.



▶ Инструкция по использованию индикатора

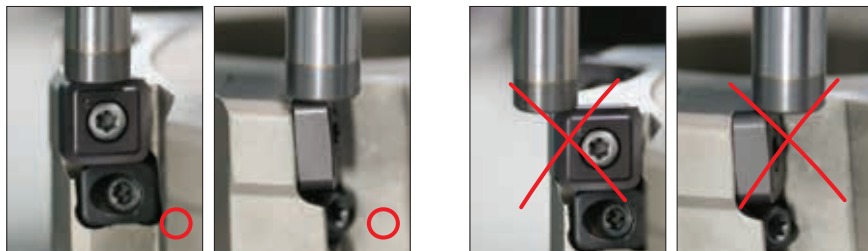

▶ Дополнительные меры предосторожности

- Помещая новую пластину удостоверьтесь, что регулировочный клин (4) находится в самом нижнем его положении. Прежде чем извлечь пластину из фрезы, регулировочный клин (4) должен полностью находиться в нижней позиции.
- Тщательно очищайте пластину и посадочное место прежде, чем поместить новую пластину/кромку.
- Во время установки регулировочного клина (4) на корпус фрезы, пожалуйста, удостоверьтесь, что регулировочный клин (4) зажат, пока он не достигнет нижней позиции.

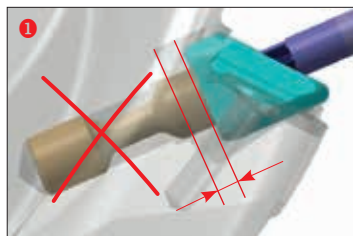

► Фрезы TOPSLOT с ZNHT & ZNHU

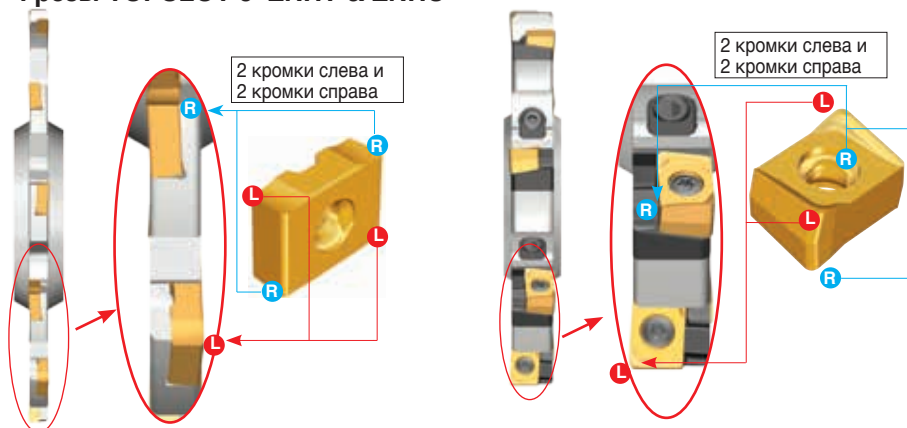

- Один тип пластины устанавливается с левой и с правой стороны

► Наименование элементов

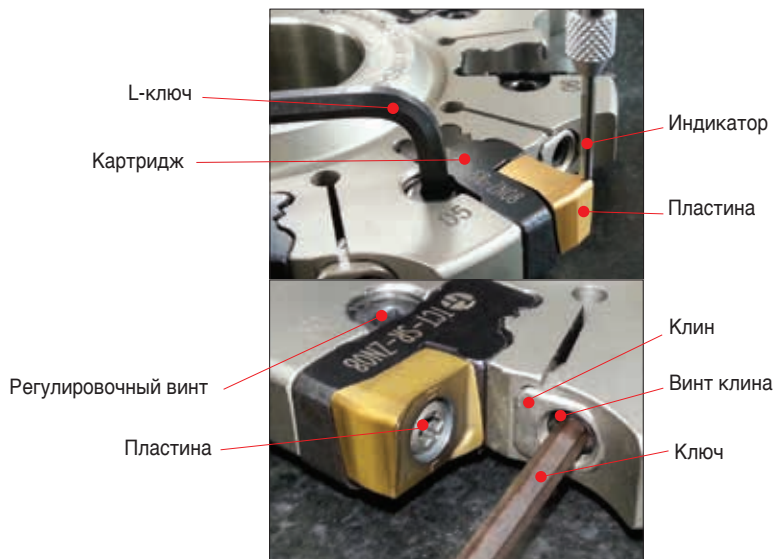

► Инструкция по регулировке ширины фрезы

■ Дисковый тип



B=Ширина резания
 (Ширина по пластинам)
 H=Толщина фрезы
 (Заданное значение)
 A=Ширина корпуса фрезы
 X=Расстояние между
 пластиной и корпусом фрезы

■ Фланцевый тип

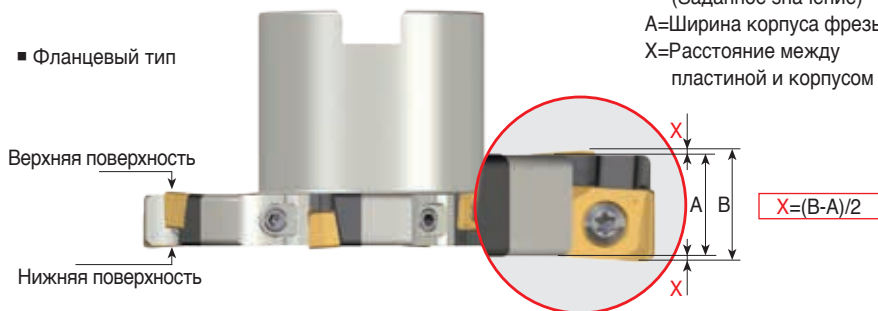

► Процесс регулировки

■ Дисковый тип

- 1 Индексировать неиспользуемые пластины плотно к картриджу.



- 4 Прорежьте такие же действия с остальными картриджами. (так же как на противоположной стороне)

- 2 Ослабьте винт клина на один поворот против часовой стрелки



- 5 После установки всех картриджей, последовательно затяните клин на 100% - около 2 или 3 поворотов.

- 3 После того как затяните клин примерно на 80% отрегулируйте картридж до желаемого значения "X", после установки исходной нулевой точки.



- При установке картриджа в значение "X" расположите картридж выше "X" и затем отрегулируйте его в значение "X".
- Вращение по часовой стрелке: картридж опускается.
- Вращение против часовой стрелки: картридж поднимается.

■ Фланцевый тип

- 1 Для установки нижней поверхности повторите шаги 1-4 для дискового типа (Исходное положение - нижняя плоскость фрезы фланцевого типа).



- 4 После того как затяните клин примерно на 80%, отрегулируйте картридж до желаемого значения (A+X).



- 2 Для установки лицевой поверхности, использование подушки обязательно и уровень высоты должен дойти до "0".



- 5 Отрегулируйте остальные картриджи таким же способом.

- 3 Расположите нижнюю поверхность на подушку и ослабьте винт клина одним поворотом против часовой стрелки.



- 6 После установки всех картриджей, последовательно затяните клин на 100% - около 2 или 3 поворотов.

- При установке картриджа в значение "X" расположите картридж выше "X" и затем отрегулируйте его в значение "X".
- Вращение по часовой стрелке: картридж опускается.
- Вращение против часовой стрелки: картридж поднимается.

► Настройка

■ Важные примечание при регулировке

- Все установки должны проводиться на чистой и ровной поверхности.
- Для улучшения точности действий, удалите все инородные тела с пластин и с места крепления перед установкой.
- При разборке клинов и винтов необходимо смазать трущиеся поверхности. (Рис.1)
- Значение "X" должно быть равным для верхней и нижней поверхностей при регулировке ширины паза.(Рис.2)
- Ширина среза должна устанавливаться в пределах величины промаркированной лазером на фрезе (Рис.3)
Ex) WIDTH 12-13 / WIDTH 20-23
- При установке картриджа в значение "X" расположите картридж выше "X" и затем отрегулируйте его в значение "X".



Рис.1 Смазка.



Рис.2 Регулировка
в значение "X"

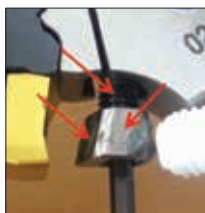

Рис.3 Ширина

▶ Дисковые фрезы

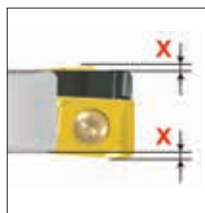

- Диаметры дисковых фрез:
75мм, 100мм, 125мм, 160мм, 250мм
- Ширина резания: 1.6мм - 6.35мм
- Геометрия: положительный передний угол
- Применение: нарезание канавок и отрезка
- Обрабатываемые материалы: углеродистые, легированные, нержавеющие стали, чугуны, алюминий, труднообрабатываемые металлы.

■ Особенности и преимущества дисковых фрез:

- ширина резания от 1,6 мм
- простая установка пластин
- надежное крепление пластин
- фиксатор пластины с автоматической установкой
- фланец для максимальной жесткости
- минимальное радиальное биение
- эффективный отвод стружки
- сниженное усилие резания
- повышенная стойкость
- экономичность

▶ Рекомендованное направление подачи для дисковых фрез TSC

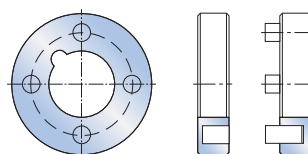
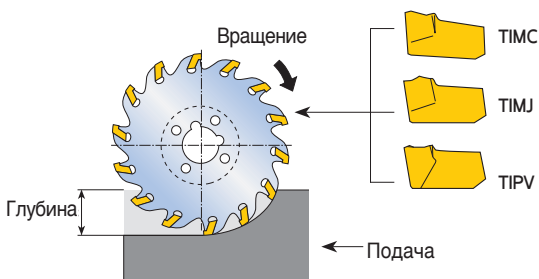

Рекомендуемый комплект фланцев для фрез 2-го типа

► Рекомендованная подача (в зависимости от ширины пластины)

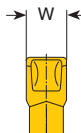
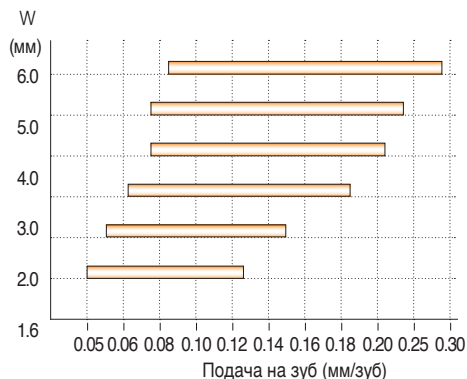

Скорость подачи для радиальной глубины резания => 1/4 диаметра фрезы.
Для радиальной глубины резания <1/4 диаметра фрезы подачу увеличить на %.

резания/диаметра фрезы	1/4	1/6	1/8	1/10	1/20
фрезы подачу увеличить на %	0%	15%	30%	45%	45%

■ Врезание

Фрезами T-CLAMP ULTRA возможно выполнять попутное, встречное фрезерование и врезную отрезку. При попутном фрезеровании на входе получается толстая стружка, а на выходе - тонкая. Рекомендуется использовать пластины с фаской.

При встречном фрезеровании на входе получается тонкая стружка, а на выходе - толстая. Рекомендуется использовать пластины с острой кромкой.

Попутное фрезерование необходимо применять во всех возможных случаях, особенно при замене дисковых фрез из быстрорежущей стали на фрезы T-CLAMP ULTRA. На станках с компенсатором зазора предпочтительно использовать попутное фрезерование.

■ Установка фрезы

Для предотвращения выдавливания шлицов на оправке и обеспечения дополнительной устойчивости во время форсированных режимов резания рекомендуется использовать комплекты приводных фланцев.

■ Установка пластин

Вручную установите пластину в ячейку и зафиксируйте ее при помощи деревянного или пластикового молотка.

Это обеспечит автоматическое позиционирование пластины и минимальное радиальное биение. Перед установкой пластин ячейки должны быть чистыми и без стружки.

Врезание под углом

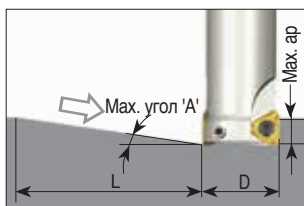

Спиральное врезание

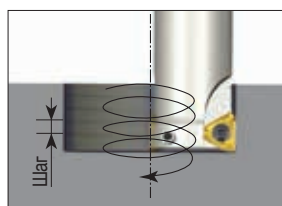

ЗРК(Н)Т 06

(Ед. изм.: мм)

Диаметр фрезы (D)	Врезание под углом			Спиральное врезание		
	Мак. угол (A°)	Мак. ap	Мин. длина (L)	Мин. диаметр	Мак. диаметр	Мак. шаг/об.
Ø12	3.7	4.7	73	19.5	24	1.3
Ø14	2.8	4.7	96	23.5	28	1.2
Ø16	2.3	4.7	117	27.5	32	1.8
Ø17	2.0	4.7	135	29.5	34	1.2
Ø18	2.0	4.7	135	31.5	36	1.6
Ø20	1.6	4.7	168	35.5	40	1.3
Ø21	1.5	4.7	180	37.5	42	1.5
Ø22	1.5	4.7	180	39.5	44	1.2
Ø25	1.5	4.7	180	45.5	50	1.5
Ø30	1.2	4.7	224	55.5	60	1.4
Ø32	1.2	4.7	224	59.5	64	1.7
Ø35	1.0	4.7	269	65.5	70	1.5
Ø40	0.7	4.7	385	75.5	80	1.8
						1.2
						1.3

ЗРК(Н)Т 10

(Ед. изм.: мм)

Диаметр фрезы (D)	Врезание под углом			Спиральное врезание		
	Мак. угол (A°)	Мак. ap	Мин. длина (L)	Мин. диаметр	Мак. диаметр	Мак. шаг/об.
Ø16	7.0	7.0	57	24.7	32	2.8
Ø20	3.3	7.0	121	33.9	40	5.2
Ø21	3.2	7.0	125	35.9	42	2.1
Ø22	3.2	7.0	125	37.9	44	3.1
Ø25	2.8	7.0	143	43.5	50	2.2
Ø26	2.6	7.0	154	45.9	52	3.3
Ø30	2.0	7.0	201	53.9	60	2.4
Ø32	1.8	7.0	223	57.5	64	2.4
Ø33	1.7	7.0	236	59.9	66	3.1
Ø40	1.3	7.0	309	73.7	80	2.2
Ø50	1.0	7.0	401	93.7	100	2.7
Ø63	0.8	7.0	502	119.7	126	2.1
						2.1
						2.6
						2.0
						2.4
						2.0
						2.3
						2.1
						2.3

Врезание под углом

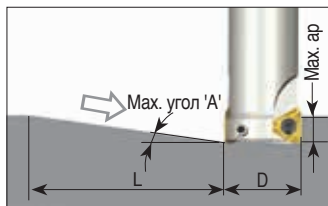

Спиральное врезание

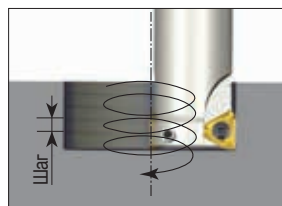

ЗРК(Н)Т 15

(Ед. изм.: мм)

Диа. фрезы (D)	Врезание под углом			Спиральное врезание		
	Max. угл. (A°)	Max. ap	Min. длина (L)	Min. diam.	Max. diam.	Max. шаг/об.
Ø32	3.2	11.0	197	53.5	64	3.2
						4.8
Ø33	3.1	11.0	203	55.5	66	3.3
						4.8
Ø35	3.1	11.0	203	59.5	70	3.5
						5.1
Ø40	2.0	11.0	315	70.1	80	2.8
						3.7
Ø50	1.5	11.0	420	90.1	100	2.8
						3.5
Ø63	1.1	11.0	573	116.1	126	2.7
						3.2
Ø80	0.8	11.0	788	150.3	160	2.6
						3.0
Ø100	0.6	11.0	1051	190.5	200	2.5
						2.8
Ø125	0.5	11.0	1261	240.3	250	2.7
						2.9
Ø160	0.3	11.0	2102	310.3	320	2.1
						2.2
Ø200	0.2	11.0	3153	390.3	400	1.8
						1.9

ЗРК(Н)Т 19

(Ед. изм.: мм)

Диа. фрезы (D)	Врезание под углом			Спиральное врезание		
	Max. угл. (A°)	Max. ap	Min. длина (L)	Min. diam.	Max. diam.	Max. шаг/об.
Ø40	3.6	15.0	239	66.7	80	4.5
						6.7
Ø50	2.2	15.0	391	87.9	100	3.9
						5.1
Ø63	1.7	15.0	506	113.9	126	4
						5
Ø80	1.3	15.0	661	147.9	160	4.1
						4.8
Ø100	1.0	15.0	860	187.9	200	4.1
						4.7
Ø125	0.8	15.0	1075	237.9	250	4.2
						4.7
Ø160	0.6	15.0	1433	307.9	320	4.1
						4.5
Ø200	0.4	15.0	2150	387.9	400	3.5
						3.7
Ø250	0.3	15.0	2866	487.9	500	3.3
						3.5

Врезание под углом

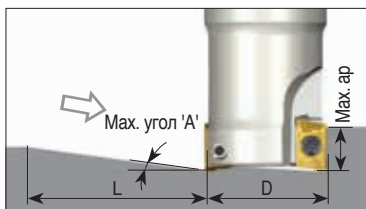

Спиральное врезание

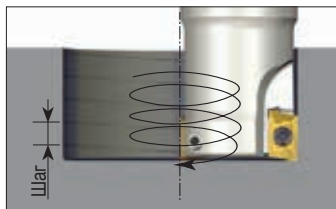

АХМТ 06

(Ед. изм.: мм)

Диаметр фрезы (D)	Врезание под углом			Спиральное врезание		
	Мак. угол (A°)	Мак. ap	Мин. длина (L)	Мин. диаметр	Мак. диаметр	Мак. шаг/об.
Ø8	1.0	5.0	287	9		0.0
					16	0.4
Ø10	8.0	5.0	36	13		1.1
					20	3.7
Ø11	6.0	5.0	48	15		1.1
					22	3.1
Ø12	6.0	5.0	48	17		1.4
					24	3.4
Ø13	5.5	5.0	52	19		1.5
					26	3.3
Ø14	4.8	5.0	60	21		1.6
					28	3.1
Ø15	4.3	5.0	67	23		1.6
					30	3.0
Ø16	4.0	5.0	72	25		1.7
					32	3.0
Ø17	3.5	5.0	82	27		1.6
					34	2.8
Ø18	5.0	5.0	57	29		2.6
					36	4.2
Ø19	4.8	5.0	60	31		2.7
					38	4.3
Ø20	4.0	5.0	72	33		2.4
					40	3.7
Ø21	3.5	5.0	82	35		2.3
					42	3.4
Ø25	3.0	5.0	95	43		2.5
					50	3.5
Ø32	2.0	5.0	143	57		2.3
					64	3.0
Ø40	1.5	5.0	191	73		2.3
					80	2.8

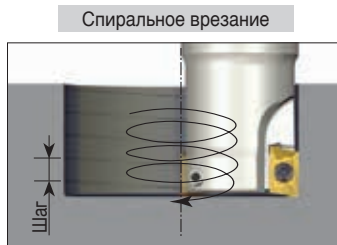

АРКТ 09

(Ед. изм.: мм)

Диаметр фрезы (D)	Врезание под углом			Спиральное врезание		
	Макс. угол (A°)	Макс. ap	Мин. длина (L)	Мин. диам.	Макс. диам.	Макс. шаг/об.
Ø10	7.5	9.0	68	14	20	1.4
						3.5
Ø12	7.3	9.0	70	16	24	1.4
						4.1
Ø14	6.0	9.0	86	18	28	1.1
						3.9
Ø16	4.9	9.0	105	21.08	32	1.2
						3.7
Ø17	4.4	9.0	117	23.08	34	1.2
						3.5
Ø18	4.0	9.0	129	25.08	36	1.3
						3.4
Ø20	3.4	9.0	152	29.08	40	1.4
						3.2
Ø21	3.1	9.0	166	31.08	42	1.5
						3.0
Ø22	2.8	9.0	184	33.08	44	1.4
						2.9
Ø25	1.8	9.0	287	39.08	50	1.2
						2.1
Ø26	2.0	9.0	258	41.08	52	1.4
						2.4
Ø30	2.2	9.0	234	49.08	60	2.0
						3.1
Ø32	2.0	9.0	258	53.08	64	2.0
						3.0
Ø33	1.7	9.0	303	55.08	66	1.7
						2.6
Ø40	1.5	9.0	344	69.08	80	2.0
						2.8
Ø50	1.1	9.0	469	89.08	100	2.0
						2.6
Ø63	0.8	9.0	645	115.08	126	1.9
						2.3
Ø80	0.5	9.0	1032	149.08	160	1.6
						1.9

АРКТ 12

(Ед. изм.: мм)

Диаметр фрезы (D)	Врезание под углом			Спиральное врезание		
	Мак. угол (A°)	Мак. ар	Мин. длина (L)	Мин. диам.	Мак. диам.	Мак. шаг/об.
Ø16	12.5	12.0	54	17.5	32	0.5
						9.5
Ø18	9.7	12.0	70	20.9	36	1.3
						8.2
Ø20	6.8	12.0	101	24.9	40	1.6
						6.4
Ø21	6.2	12.0	111	26.9	42	1.7
						6.1
Ø25	8.0	12.0	85	34.9	50	3.7
						9.4
Ø26	7.5	12.0	91	36.9	52	3.8
						9.1
Ø32	5.0	12.0	137	48.9	64	3.9
						7.5
Ø33	4.6	12.0	149	50.9	66	3.8
						7.1
Ø40	3.5	12.0	196	64.9	80	4.1
						6.5
Ø50	2.5	12.0	275	84.9	100	4.8
						5.8
Ø63	1.7	12.0	405	110.9	126	4.5
						5.0
Ø80	1.3	12.0	529	144.9	160	4.6
						4.8

АРКТ 17

(Ед. изм.: мм)

Диаметр фрезы (D)	Врезание под углом			Спиральное врезание		
	Мак. угол (A°)	Мак. ар	Мин. длина (L)	Мин. диам.	Мак. диам.	Мак. шаг/об.
Ø20	8.0	16.1	115	22	40	0.7
						7.5
Ø25	5.0	16.1	184	30.6	50	1.3
						5.8
Ø26	4.0	16.1	230	32.6	52	1.2
						4.9
Ø32	9.0	16.1	102	44.6	64	5.3
						13.5
Ø33	9.0	16.1	102	46.6	66	5.7
						13.9
Ø40	5.0	16.1	184	60.6	80	4.8
						9.3
Ø50	4.4	16.1	209	80.6	100	6.3
						10.3
Ø63	3.2	16.1	288	106.6	126	6.5
						9.4
Ø80	2.3	16.1	401	140.6	160	6.5
						8.6
Ø100	1.8	16.1	513	180.6	200	6.8
						8.4
Ø125	1.4	16.1	659	230.6	250	6.9
						8.1
Ø160	1.0	16.1	923	300.6	320	6.5
						7.5
Ø200	0.7	16.1	1318	380.6	400	5.9
						6.5

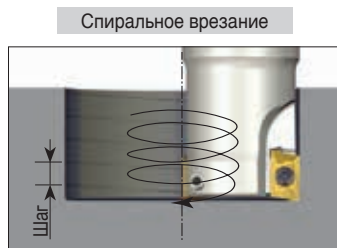
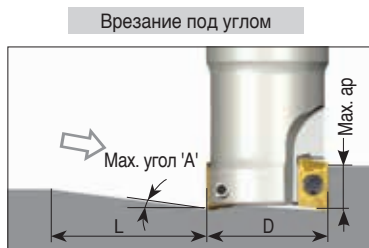

АРКТ 19

(Ед. изм.: мм)

Диаметр фрезы (D)	Врезание под углом			Спиральное врезание		
	Мак. угол (A°)	Мак. ap	Мин. длина (L)	Мин. диам.	Мак. диам.	Мак. шаг/об.
Ø40	6.0	17.5	167	56	80	4.5
						11.2
Ø50	4.0	17.5	250	76	100	4.9
						9.3
Ø63	2.9	17.5	346	102	126	5.3
						8.5
Ø80	2.1	17.5	477	136	160	5.5
						7.8
Ø100	1.6	17.5	627	176	200	5.7
						7.5
Ø125	1.2	17.5	736	226	250	5.6
						7.0
Ø160	0.9	17.5	1115	296	320	5.7
						6.7
Ø200	0.7	17.5	1433	376	400	5.7
						6.5

Врезание под углом

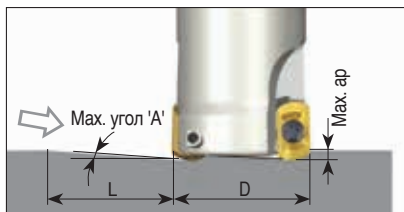

Спиральное врезание

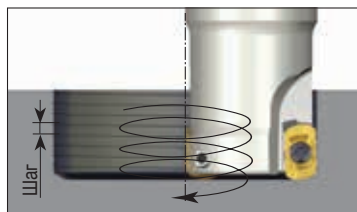

АХМТ 0602R-HF

(Ед. изм.: мм)

Диаметр фрезы (D)	Врезание под углом			Спиральное врезание		
	Мак. угол (A°)	Мак. ap	Мин. длина (L)	Мин. диаметр	Мак. диаметр	Мак. шаг/об.
Ø8	0.3	0.5	96	14	16	0.1
						0.1
Ø10	0.5	0.5	57	14	20	0.2
						0.3
Ø11	1.0	0.5	29	18	22	0.3
						0.5
Ø12	2.3	0.5	12	18	24	0.5
						0.5
Ø13	4.5	0.5	6	18	26	0.5
						0.5
Ø14	3.5	0.5	8	18	28	0.5
						0.5
Ø15	3.0	0.5	10	26	30	0.5
						0.5
Ø16	2.8	0.5	10	26	32	0.5
						0.5
Ø17	2.5	0.5	11	26	34	0.5
						0.5
Ø18	2.3	0.5	12	26	36	0.5
						0.5
Ø19	2.2	0.5	13	26	38	0.5
						0.5
Ø20	1.9	0.5	15	34	40	0.5
						0.5
Ø21	1.7	0.5	17	34	42	0.5
						0.5
Ø25	1.4	0.5	20	44	50	0.5
						0.5
Ø32	1.0	0.5	29	58	64	0.5
						0.5
Ø40	0.7	0.5	41	74	80	0.5
						0.5

Технические данные для программирования

При написании УП выбирайте программируемый радиус "R" для каждого габарита пластины. При этом толщина необработанного материала будет составлять величину около значения "B" вдоль радиуса.

При написании УП с выбранным "R" область зареза будет составлять "A"

Чтобы не допустить зарез детали добавьте в стратегии дополнительный припуск "A" для черновой обработки. Информация по программируемым "R" в таблице ниже.

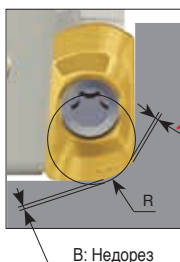

	Программируемый R	Зарез A	B Недорез
АХМТ 0602R-HF	0.9	0	0.22
	1.0	0.01	0.19
	1.5	0.16	0.05
	2.0	0.35	0
АРКТ 09Т3R-HF	1.5	0	0.47
	1.7	0	0.29
	2.0	0.04	0.3
	2.5	0.18	0.15
АРКТ 1204R-HF	3.0	0.36	0.04
	2	0	0.57
	2.5	0.07	0.42
	3	0.21	0.28
	3.5	0.39	0.15
	4	0.58	0.06

■ : Рекомендованный программируемый 'R'

АРКТ 09Т3R-HF

(Ед. изм.: мм)

Диаметр фрезы (D)	Врезание под углом			Спиральное врезание		
	Мак. угол (A°)	Мак. ар	Мин. длина (L)	Мин. диам.	Мак. диам.	Мак. шаг/об.
Ø16	3.8	1.0	15	22	32	1.0
Ø17	3.5	1.0	16	24	34	1.0
Ø18	3.4	1.0	17	26	36	1.0
Ø20	3.0	1.0	19	30	40	1.0
Ø21	2.3	1.0	25	32	42	1.0
Ø22	2.0	1.0	29	34	44	1.0
Ø25	2.1	1.0	27	40	50	1.0
Ø26	2.0	1.0	29	42	52	1.0
Ø30	1.8	1.0	32	50	60	1.0
Ø32	1.6	1.0	36	54	64	1.0
Ø33	1.5	1.0	38	56	66	1.0
Ø40	1.2	1.0	48	70	80	1.0
Ø50	0.9	1.0	64	90	100	1.0
Ø63	0.5	1.0	115	116	126	1.0
Ø80	0.4	1.0	143	150	160	1.0

АРКТ 1204R-HF

(Ед. изм.: мм)

Диаметр фрезы (D)	Врезание под углом			Спиральное врезание		
	Мак. угол (A°)	Мак. ар	Мин. длина (L)	Мин. диам.	Мак. диам.	Мак. шаг/об.
Ø16	3.8	1.2	18	21	32	0.8
Ø18	4.0	1.2	17	24	36	1.1
Ø20	4.0	1.2	17	27	40	1.2
Ø21	3.5	1.2	20	29	42	1.2
Ø25	2.5	1.2	27	37	50	1.2
Ø26	2.3	1.2	30	39	52	1.2
Ø32	1.7	1.2	40	51	64	1.2
Ø33	1.7	1.2	40	53	66	1.2
Ø40	1.5	1.2	46	67	80	1.2
Ø50	1.1	1.2	63	86	100	1.2
Ø63	1.0	1.2	69	112	126	1.2
Ø80	0.8	1.2	86	146	160	1.2

Врезание под углом

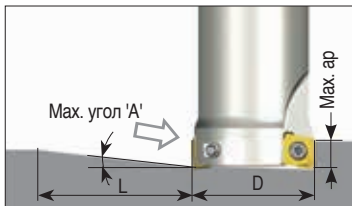

Спиральное врезание

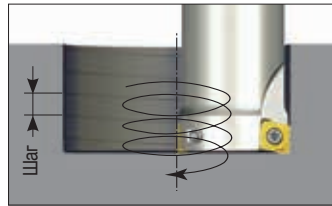

2РКТ 05

(Ед. изм.: мм)

Диаметр фрезы (D)	Врезание под углом			Спиральное врезание		
	Мак. угол (A°)	Мак. ар	Мин. длина (L)	Мин. диаметр	Мак. диаметр	Мак. шаг/об.
Ø12	7.5	4.7	36	15.9		1.4
					24	4.2
Ø13	6.6	4.7	41	17.9		1.5
					26	4.0
Ø16	4.4	4.7	61	23.9		1.6
					32	3.3
Ø17	4.1	4.7	66	25.9		1.7
					34	3.3
Ø20	3.0	4.7	90	31.9		1.7
					40	2.8
Ø21	2.8	4.7	96	33.9		1.7
					42	2.7
Ø25	2.2	4.7	122	41.9		1.7
					50	2.6
Ø26	2.2	4.7	122	43.9		1.8
					52	2.7
Ø32	1.6	4.7	168	55.9		1.8
					64	2.4
Ø33	1.6	4.7	168	57.9		1.9
					66	2.5
Ø40	1.2	4.7	224	71.9		1.8
					80	2.2

Врезание под углом

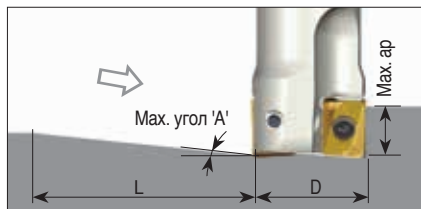

Спиральное врезание

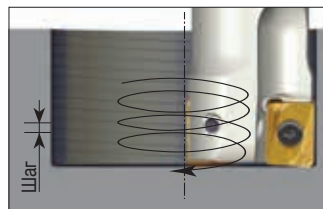

АНН(М)Х 11

(Ед. изм.: мм)

Диа. фрезы (D)	Врезание под углом			Спиральное врезание		
	Max. угол (A°)	Max. ap	Min. длина (L)	Min. diam.	Max. diam.	Max. шаг/об.
Ø25	1.5	11.0	420	30	50	0.3
						1.7
Ø26	1.4	11.0	450	32	52	0.4
						1.7
Ø32	1.1	11.0	573	44	64	0.6
						1.6
Ø33	1.0	11.0	631	46	66	0.6
						1.5
Ø40	0.8	11.0	788	60	80	0.7
						1.5
Ø50	0.6	11.0	1051	80	100	0.8
						1.4
Ø63	0.4	11.0	1576	106	126	0.8
						1.2
Ø80	0.3	11.0	2102	140	160	0.8
						1.1
Ø100	0.2	11.0	3153	180	200	0.7
						0.9
Ø125	0.2	11.0	3153	230	250	1.0
						1.2

АНН(М)Х 16

(Ед. изм.: мм)

Диа. фрезы (D)	Врезание под углом			Спиральное врезание		
	Max. угол (A°)	Max. ap	Min. длина (L)	Min. diam.	Max. diam.	Max. шаг/об.
Ø32	1.2	15.0	716	44	64	0.7
						1.8
Ø33	1.0	15.0	560	46	66	0.6
						1.5
Ø40	0.9	15.0	955	60	80	0.8
						1.7
Ø50	0.8	15.0	1075	80	100	1.1
						1.9
Ø63	0.6	15.0	1433	106	126	1.2
						1.8
Ø80	0.45	15.0	1911	140	160	1.3
						1.7
Ø100	0.35	15.0	2457	180	200	1.3
						1.6
Ø125	0.25	15.0	3439	230	250	1.2
						1.5
Ø160	0.15	15.0	5732	300	320	1.0
						1.1
Ø200	0.1	15.0	8599	380	400	0.8
						0.9

Врезание под углом

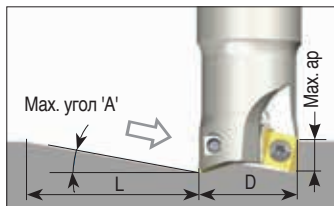

Спиральное врезание

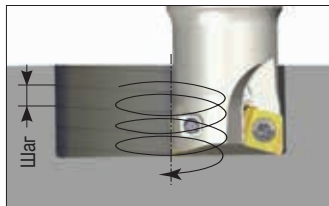

4НКТ 06

(Ед. изм.: мм)

Диаметр фрезы (D)	Врезание под углом			Спиральное врезание		
	Мак. угол (A°)	Мак. ap	Мин. длина (L)	Мин. диаметр	Мак. диаметр	Мак. шаг/об.
Ø16	3.5	6	98	21.5	32	0.8
				25.5		2.5
Ø18	4.0	6	86	29.5	36	1.3
				39.5		3.2
Ø20	4.2	6	82	53.5	40	1.8
				69.5		3.7
Ø25	4.9	6	70	89.5	50	3.1
				115.5		5.4
Ø32	3.5	6	98	126	64	3.3
				172		4.9
Ø40	2.6	6	132	229	80	3.4
				300		4.6
Ø50	2.0	6	172	400	100	3.5
				500		4.4
Ø63	1.5	6	229	630	126	3.5
				800		4.1

Попутное ступенчатое фрезерование

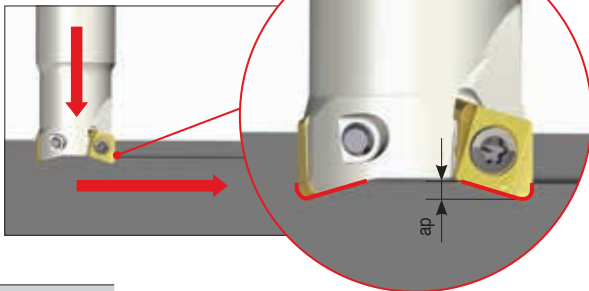
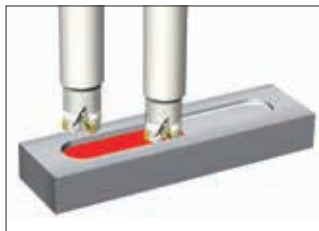

Макс. глубина резания (мм)

Диаметр фрезы (D)	Мак. ap
Ø16	0.7
Ø18	0.9
Ø20	1.0
Ø25~	1.5

• Для пластин с R0.8

Врезание под углом

Спиральное врезание

Врезание торцом

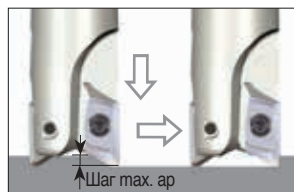
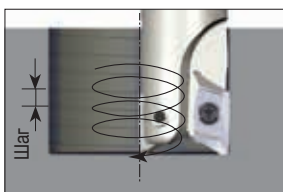
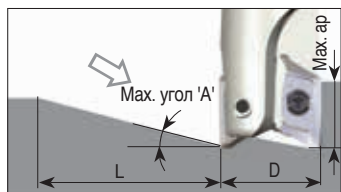

XEVT 16: 0.4R-1.6R

(Ед. изм.: мм)

Диа. фрезы (D)	Врезание под углом			Спиральное врезание			Врезание торцом
	Мак. угол (A°)	Мак. ap	Мин. длина (L)	Мин. диам.	Мак. диам.	Мак. шаг/об.	Мак. ap
Ø25	23.5	16	37	29.1	50	4.8	4
						13.6	4
Ø32	14.5	16	62	43.1	64	7.7	4
						13.6	4
Ø40	10.0	16	91	59.1	80	9.0	4
						13.6	4
Ø50	7.5	16	122	79.1	100	10.2	4
						13.6	4
Ø63	5.5	16	166	105.1	126	10.8	4
						13.6	4
Ø80	4.5	16	203	139.1	160	12.4	4
						13.6	4
Ø100	3.3	16	278	179.1	200	12.2	4
						13.6	4
Ø125	2.5	16	367	229.1	250	12.1	4
						13.6	4
Ø160	1.5	16	611	299.1	320	9.7	4
						11.2	4
Ø200	1.0	16	917	379.1	400	8.3	4
						9.3	4

XEVT 16: 2.0R

(Ед. изм.: мм)

Диа. фрезы (D)	Врезание под углом			Спиральное врезание			Врезание торцом
	Мак. угол (A°)	Мак. ap	Мин. длина (L)	Мин. диам.	Мак. диам.	Мак. шаг/об.	Мак. ap
Ø25	23.5	15.5	36	29.1	50	4.8	3.5
						13.2	3.5
Ø32	14.5	15.5	60	43.1	64	7.7	3.5
						13.2	3.5
Ø40	10.0	15.5	88	59.1	80	9.0	3.5
						13.2	3.5
Ø50	7.5	15.5	118	79.1	100	10.2	3.5
						13.2	3.5
Ø63	5.5	15.5	161	105.1	126	10.8	3.5
						13.2	3.5
Ø80	4.5	15.5	197	139.1	160	12.4	3.5
						13.2	3.5
Ø100	3.3	15.5	269	179.1	200	12.2	3.5
						13.2	3.5
Ø125	2.5	15.5	355	229.1	250	12.1	3.5
						13.2	3.5
Ø160	1.5	15.5	592	299.1	320	9.7	3.5
						11.2	3.5
Ø200	1.0	15.5	888	379.1	400	8.3	3.5
						9.3	3.5

Врезание под углом

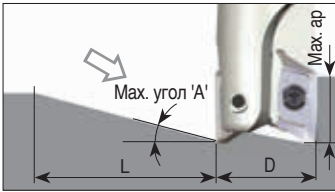

Спиральное врезание

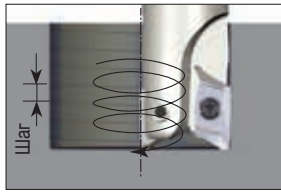

Врезание торцом

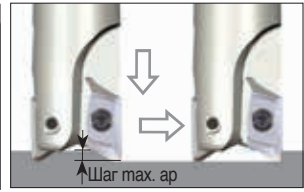

XEVT 16: 3.0R-3.2R

(Ед. изм.: мм)

Диаметр фрезы (D)	Врезание под углом			Спиральное врезание			Врезание торцом
	Мак. угол (A°)	Мак. ар	Мин. длина (L)	Мин. диаметр	Мак. диаметр	Мак. шаг/об.	Мак. ар
Ø25	22.5	14.5	35	29.1	50	4.5	2.8
						12.3	2.8
Ø32	13.5	14.5	60	43.1	64	7.1	2.8
						12.3	2.8
Ø40	9.0	14.5	92	59.1	80	8.1	2.8
						12.3	2.8
Ø50	6.5	14.5	127	79.1	100	8.8	2.8
						12.3	2.8
Ø63	5.0	14.5	166	105.1	126	9.8	2.8
						12.3	2.8
Ø80	4.0	14.5	207	139.1	160	11.0	2.8
						12.3	2.8
Ø100	3.0	14.5	277	179.1	200	11.1	2.8
						12.3	2.8
Ø125	2.0	14.5	415	229.1	250	9.7	2.8
						11.6	2.8
Ø160	1.1	14.5	756	299.1	320	7.1	2.8
						8.2	2.8
Ø200	0.8	14.5	1039	379.1	400	6.7	2.8
						7.4	2.8

XEVT 16: 4.0R-5.0R

(Ед. изм.: мм)

Диаметр фрезы (D)	Врезание под углом			Спиральное врезание			Врезание торцом
	Мак. угол (A°)	Мак. ар	Мин. длина (L)	Мин. диаметр	Мак. диаметр	Мак. шаг/об.	Мак. ар
Ø25	20.0	14.5	40	29.1	50	4.0	2.4
						12.3	2.4
Ø32	12.0	14.5	68	43.1	64	6.3	2.4
						12.3	2.4
Ø40	7.5	14.5	110	59.1	80	6.7	2.4
						12.3	2.4
Ø50	5.5	14.5	151	79.1	100	7.5	2.4
						12.3	2.4
Ø63	4.5	14.5	184	105.1	126	8.8	2.4
						12.3	2.4
Ø80	3.5	14.5	237	139.1	160	9.6	2.4
						12.3	2.4
Ø100	3.0	14.5	277	179.1	200	11.1	2.4
						12.3	2.4
Ø125	2.0	14.5	415	229.1	250	9.7	2.4
						11.6	2.4
Ø160	1.0	14.5	831	299.1	320	6.5	2.4
						7.5	2.4
Ø200	0.7	14.5	1187	379.1	400	5.8	2.4
						6.5	2.4

Врезание под углом

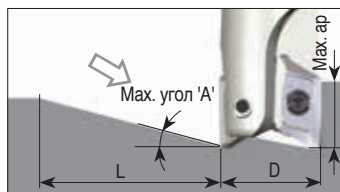

Спиральное врезание

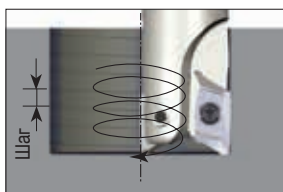

Врезание торцом

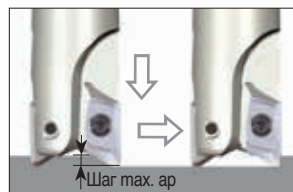

XEVT 22: 0.5R-0.8R

(Ед. изм.: мм)

Диа. фрезы (D)	Врезание под углом			Спиральное врезание			Врезание торцом
	Мак. угол (A°)	Мак. ap	Мин. длина (L)	Мин. диам.	Мак. диам.	Мак. шаг/об.	Мак. ap
Ø32	20.0	21	58	38.5	64	6.3	4.7
						17.9	4.7
Ø40	14.0	21	84	54.5	80	9.6	4.7
						17.9	4.7
Ø50	9.5	21	126	74.5	100	10.9	4.7
						17.9	4.7
Ø63	7.0	21	171	100.5	126	12.3	4.7
						17.9	4.7
Ø80	5.0	21	240	134.5	160	12.7	4.7
						17.9	4.7
Ø100	3.7	21	325	174.5	200	12.9	4.7
						17.3	4.7
Ø125	2.6	21	463	224.5	250	12.1	4.7
						15.1	4.7
Ø200	1.6	21	752	374.5	400	13.0	4.7
						14.9	4.7

XEVT 22: 1.6R-2.0R

(Ед. изм.: мм)

Диа. фрезы (D)	Врезание под углом			Спиральное врезание			Врезание торцом
	Мак. угол (A°)	Мак. ap	Мин. длина (L)	Мин. диам.	Мак. диам.	Мак. шаг/об.	Мак. ap
Ø32	19.5	20.3	57	38.5	64	6.1	4.2
						17.3	4.2
Ø40	13.5	20.3	85	54.5	80	9.3	4.2
						17.3	4.2
Ø50	9.5	20.3	121	74.5	100	10.9	4.2
						17.3	4.2
Ø63	6.7	20.3	173	100.5	126	11.8	4.2
						17.3	4.2
Ø80	4.7	20.3	247	134.5	160	12.0	4.2
						17.3	4.2
Ø100	3.5	20.3	332	174.5	200	12.2	4.2
						16.3	4.2
Ø125	2.5	20.3	465	224.5	250	11.6	4.2
						14.6	4.2
Ø200	1.5	20.3	776	374.5	400	12.2	4.2
						14.0	4.2

Врезание под углом

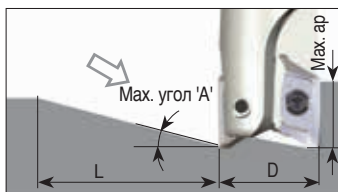

Спиральное врезание

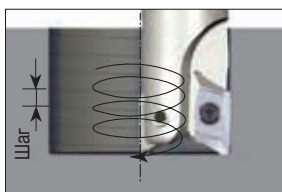

Врезание торцом

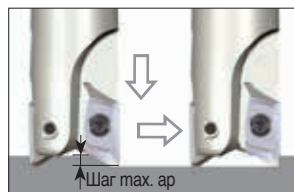

ХЕВТ 22: 3.0R-4.0R

(Ед. изм.: мм)

Диаметр фрезы (D)	Врезание под углом			Спиральное врезание			Врезание торцом
	Мак. угол (А°)	Мак. ар	Мин. длина (L)	Мин. диаметр	Мак. диаметр	Мак. шаг/об.	Мак. ар
Ø32	18.5	19.5	58	38.5	64	5.8	3.3
						16.6	3.3
Ø40	12.5	19.5	88	54.5	80	8.6	3.3
						16.6	3.3
Ø50	8.5	19.5	131	74.5	100	9.8	3.3
						16.6	3.3
Ø63	5.5	19.5	203	100.5	126	9.6	3.3
						16.2	3.3
Ø80	4.0	19.5	279	134.5	160	10.2	3.3
						14.9	3.3
Ø100	3.0	19.5	372	174.5	200	10.4	3.3
						14.0	3.3
Ø125	2.0	19.5	559	224.5	250	9.3	3.3
						11.6	3.3
Ø200	1.0	19.5	1118	374.5	400	8.1	3.3
						9.3	3.3

ХЕВТ 22: 5.0R

(Ед. изм.: мм)

Диаметр фрезы (D)	Врезание под углом			Спиральное врезание			Врезание торцом
	Мак. угол (А°)	Мак. ар	Мин. длина (L)	Мин. диаметр	Мак. диаметр	Мак. шаг/об.	Мак. ар
Ø32	17.5	19	60	38.5	64	5.5	2.8
						16.2	2.8
Ø40	11.5	19	93	54.5	80	7.9	2.8
						16.2	2.8
Ø50	7.5	19	144	74.5	100	8.6	2.8
						16.2	2.8
Ø63	5.0	19	217	100.5	126	8.8	2.8
						14.7	2.8
Ø80	3.5	19	311	134.5	160	8.9	2.8
						13.1	2.8
Ø100	2.5	19	435	174.5	200	8.7	2.8
						11.6	2.8
Ø125	1.7	19	641	224.5	250	7.9	2.8
						9.9	2.8
Ø200	0.8	19	1361	374.5	400	6.5	2.8
						7.4	2.8

Врезание под углом

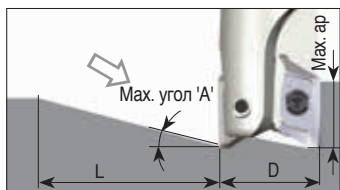

Спиральное врезание

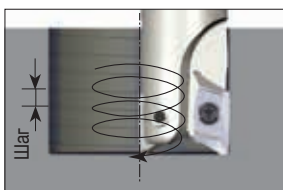

Врезание торцом

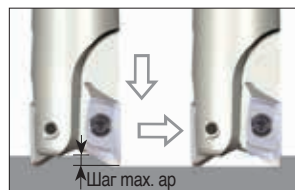

XEVT 22: 6.4R

(Ед. изм.: мм)

Диаметр фрезы (D)	Врезание под углом			Спиральное врезание			Врезание торцом
	Мак. угол (A°)	Мак. ap	Мин. длина (L)	Мин. диам.	Мак. диам.	Мак. шаг/об.	Мак. ap
Ø32	16	18.2	64	38.5	64	5.0	2.1
						15.5	2.1
Ø40	10	18.2	103	54.5	80	6.8	2.1
						15.5	2.1
Ø50	6.5	18.2	160	74.5	100	7.4	2.1
						15.2	2.1
Ø63	4.5	18.2	231	100.5	126	7.9	2.1
						13.2	2.1
Ø80	3.0	18.2	347	134.5	160	7.6	2.1
						11.2	2.1
Ø100	2.0	18.2	521	174.5	200	6.9	2.1
						9.3	2.1
Ø125	1.5	18.2	695	224.5	250	7.0	2.1
						8.7	2.1
Ø200	0.7	18.2	1490	374.5	400	5.7	2.1
						6.5	2.1

Врезание под углом

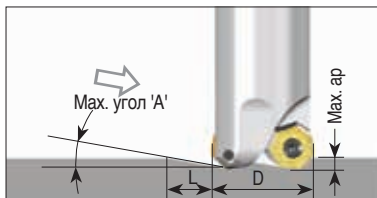

Спиральное врезание

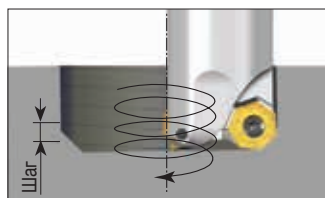

7EMT 06

(Ед. изм.: мм)

Диа. фрезы (D)	Врезание под углом			Спиральное врезание		
	Мах. угол (A°)	Мах. ар	Мин. длина (L)	Мин. диам.	Мах. диам.	Мах. шаг/об.
Ø32	29	3.2	6	45.5		3.2
					64	3.2
Ø40	15.5	3.2	12	61.5		3.2
					80	3.2
Ø50	9.5	3.2	19	81.5		3.2
					100	3.2
Ø63	5.5	3.2	33	107.5		3.2
					126	3.2
Ø80	4.0	3.2	46	141.5		3.2
					160	3.2
Ø100	3.0	3.2	61	181.5		3.2
					200	3.2
Ø125	2.0	2.3	66	231.5		3.2
					250	3.2

Технические данные для программирования

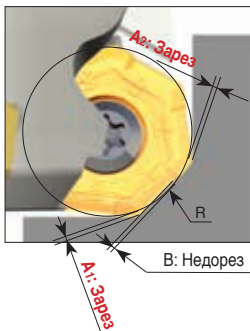

	Программируемый R	Зарез A		B Недорез
		A1	A2	B
7EMT 06	3	0	0	1.77
	4.5	0	0	1.51
	5	0.03	0.02	0.94
	6	0.21	0.19	0.53

4.5 : Рекомендованный программируемый 'R'

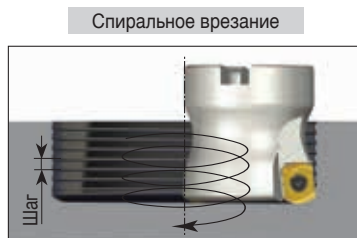

BLMP 06

(Ед. изм.: мм)

Диаметр фрезы (D)	Врезание под углом			Спиральное врезание		
	Мак. угол (A°)	Мак. ap	Мин. длина (L)	Мин. диаметр	Мак. диаметр	Мак. шаг/об.
Ø16	2.0	0.7	13	23		0.7
					32	0.7
Ø17	2.0	0.7	15	25		0.7
					34	0.7
Ø18	2.3	0.7	16	27		0.7
					36	0.7
Ø20	1.5	1.0	38	31		0.8
					40	1.0
Ø21	1.5	1.0	38	33		0.8
					42	1.0
Ø22	1.5	1.0	38	35		1.0
					44	1.0
Ø25	1.3	1.0	41	41		1.0
					50	1.0
Ø26	1.2	1.0	44	43		1.0
					52	1.0
Ø30	1.0	1.0	52	51		1.0
					60	1.0
Ø32	0.9	1.0	57	55		1.0
					64	1.0
Ø33	0.9	1.0	57	57		1.0
					66	1.0
Ø35	0.8	1.0	57	61		1.0
					70	1.0
Ø40	0.7	1.0	64	71		1.0
					80	1.0
Ø42	0.7	1.0	72	75		1.0
					84	1.0
Ø50	0.6	1.0	96	91		1.0
					100	1.0
Ø52	0.6	1.0	96	95		1.0
					104	1.0
Ø63	0.5	1.0	115	117		1.0
					126	1.0
Ø66	0.5	1.0	115	123		1.0
					132	1.0

BLMP 09

(Ед. изм.: мм)

Диаметр фрезы (D)	Врезание под углом			Спиральное врезание		
	Мак. угол (A°)	Мак. ар	Мин. длина (L)	Мин. диаметр	Мак. диаметр	Мак. шаг/об.
Ø25	2.2	1.5	39	42	50	1.5
				50		1.5
Ø26	2.2	1.5	39	44	52	1.5
				52		1.5
Ø30	2.0	1.5	43	52	60	1.5
				60		1.5
Ø32	2.0	1.5	43	56	64	1.5
				64		1.5
Ø33	2.0	1.5	43	58	66	1.5
				66		1.5
Ø35	2.0	1.5	43	60	70	1.5
				70		1.5
Ø40	1.5	1.5	57	72	80	1.5
				80		1.5
Ø42	1.5	1.5	57	76	84	1.5
				84		1.5
Ø50	1.0	1.5	86	92	100	1.5
				100		1.5
Ø52	1.0	1.5	86	96	104	1.5
				104		1.5
Ø63	0.9	1.5	96	118	126	1.5
				126		1.5
Ø66	0.9	1.5	96	124	132	1.5
				132		1.5
Ø80	0.8	1.5	107	152	160	1.5
				160		1.5
Ø100	0.7	1.5	123	192	200	1.5
				200		1.5
Ø125	0.4	1.5	215	240	250	1.5
				250		1.5

Технические данные для программирования

При написании УП выбирайте программируемый радиус "R" для каждого габарита пластины. При этом толщина необработанного материала будет составлять величину около значения "B" вдоль радиуса.

При написании УП с выбранным "R" область зареза будет составлять "A"

Чтобы не допустить зарез детали добавьте в стратегии дополнительный припуск "A" для черновой обработки. Информация по программируемым "R" в таблице ниже.

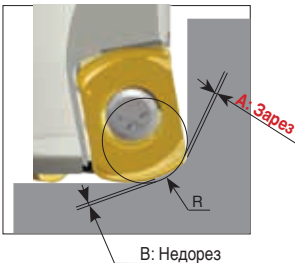

	Программируемый R	Зарез A	B Недорез
BLMP 06	2.0	0	0.42
	2.5	0.12	0.26
	3.0	0.29	0.17
BLMP 09	2.5	0	0.61
	3.0	0.09	0.45
	3.5	0.24	0.30
	4.0	0.41	0.17
	3.0	0.36	0.04

■ : Рекомендованный программируемый 'R'

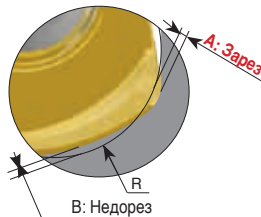

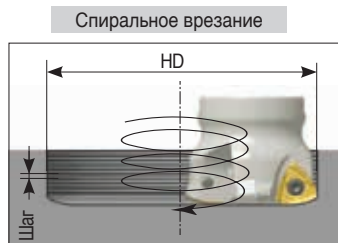

BLMP 13

(Ед. изм.: мм)

Диаметр фрезы (D)	Врезание под углом			Спиральное врезание		
	Max. угол (A°)	Max. ар	Min. длина (L)	Min. диаметр	Max. диаметр	Max. шар/об.
Ø32	0.8	2	143	50	64	0.7
Ø33	1.1	2	104	52	66	1.0
Ø35	1.1	2	104	56	70	1.1
Ø40	1.2	2	96	66	80	1.3
Ø42	1.1	2	104	70	84	1.4
Ø50	0.8	2	143	86	100	1.6
Ø52	0.8	2	143	90	104	1.2
Ø63	0.6	2	191	112	126	1.3
Ø66	0.6	2	191	118	132	1.2
Ø80	0.5	2	229	146	160	1.4
Ø100	0.4	2	287	186	200	1.3
Ø125	0.3	2	382	236	250	1.4
Ø160	0.3	2	382	306	320	1.2
Ø200	0.2	2	573	386	400	1.6
Ø250	0.2	2	573	486	500	1.3
						1.4
						1.7

Технические данные для программирования

При написании УП выбирайте программируемый радиус "R" для каждого габарита пластины. При этом толщина необработанного материала будет составлять величину около значения "B" вдоль радиуса.

При написании УП с выбранным "R" область зареза будет составлять "A"

Чтобы не допустить зарез детали добавьте в стратегии дополнительный припуск "A" для черновой обработки. Информация по программируемым "R" в таблице ниже.

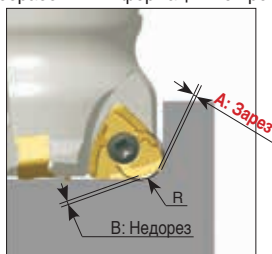

	Программируемый R	Зарез A	B Недорез
BLMP 13	3.0	0	1.31
	3.5	0	1.17
	4.0	0.04	1.03
	4.5	0.15	0.89
	5.0	0.3	0.76

■ : Рекомендованный программируемый 'R'

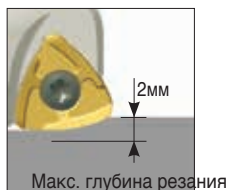

Врезание под углом

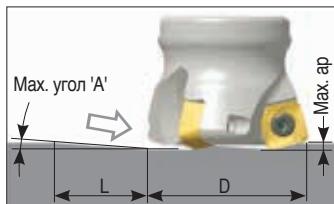

Спиральное врезание

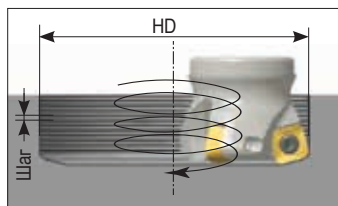

SBMT 13

(Ед. изм.: мм)

Диаметр фрезы (D)	Врезание под углом			Спиральное врезание		
	Мак. угол (A°)	Мак. ap	Мин. длина (L)	Мин. диаметр	Мак. диаметр	Мак. шаг/об.
Ø32	7.0	2	16	47	64	2.0
Ø33	6.9	2	17	49	66	2.0
Ø35	6.4	2	18	53	70	2.0
Ø40	5.3	2	22	63	80	2.0
Ø42	4.4	2	26	67	84	2.0
Ø50	4.3	2	27	83	100	2.0
Ø52	4.0	2	29	87	104	2.0
Ø63	2.9	2	40	109	126	2.0
Ø80	2.0	2	57	143	160	2.0
Ø100	1.5	2	76	183	200	2.0
Ø125	1.1	2	104	233	250	2.0
Ø160	0.8	2	104	303	320	2.0
Ø200	0.6	2	127	383	400	2.0
Ø250	0.5	2	164	483	500	2.0

Технические данные для программирования

При написании УП выбирайте программируемый радиус "R" для каждого габарита пластины. При этом толщина необработанного материала будет составлять величину около значения "B" вдоль радиуса.

При написании УП с выбранным "R" область зареза будет составлять "A"

Чтобы не допустить зарез детали добавьте в стратегии дополнительный припуск "A" для черновой обработки. Информация по программируемым "R" в таблице ниже.

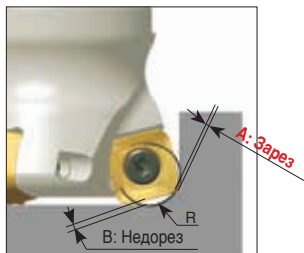

SBMT 13	Программируемый R	Зарез A	B Недорез
	4.0	0	1.62
4.5	0	1.51	
5.0	0.04	1.4	
5.5	0.14	1.29	
6.0	0.28	1.18	

4.0 : Рекомендованный программируемый 'R'

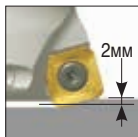

Макс. глубина резания

Врезание под углом

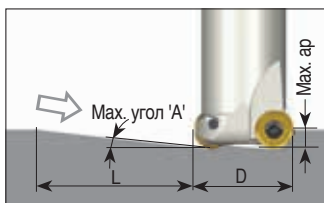

Спиральное врезание

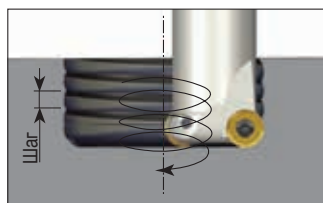

RNMU 10

(Ед. изм.: мм)

Диаметр фрезы (D)	Врезание под углом			Спиральное врезание		
	Мак. угол (A°)	Мак. ap	Мин. длина (L)	Мин. диаметр	Мак. диаметр	Мак. шаг/об.
Ø25	1.1	5.0	261	33	50	0.4
Ø26	1.1	5.0	261	35	52	1.3
						1.3
Ø32	0.9	5.0	318	47	64	0.6
						1.3
Ø33	0.9	5.0	318	49	66	0.7
						1.4
Ø40	0.9	5.0	318	63	80	1.0
						1.7
Ø42	0.9	5.0	318	67	84	1.0
						1.8
Ø50	0.7	5.0	409	83	100	1.1
						1.6
Ø52	0.8	5.0	358	87	104	1.3
						1.9

RNMU 12

(Ед. изм.: мм)

Диаметр фрезы (D)	Врезание под углом			Спиральное врезание		
	Мак. угол (A°)	Мак. ap	Мин. длина (L)	Мин. диаметр	Мак. диаметр	Мак. шаг/об.
Ø32	1.4	6.0	246	42	64	0.7
						2.1
Ø33	1.4	6.0	246	44	66	0.7
						2.2
Ø40	1.3	6.0	265	58	80	1.1
						2.4
Ø50	1.0	6.0	344	78	100	1.3
						2.3
Ø52	1.0	6.0	344	82	104	1.4
						2.4
Ø63	1.0	6.0	344	104	126	1.9
						2.9
Ø66	1.0	6.0	344	110	132	2.0
						3.1
Ø80	0.9	6.0	382	138	160	2.4
						3.4
Ø100	0.7	6.0	491	178	200	2.5
						3.3

RNMU 16

(Ед. изм.: мм)

Диа. фрезы (D)	Врезание под углом			Спиральное врезание		
	Мах. угол (A°)	Мах. ар	Min. длина (L)	Min. диам.	Мах. диам.	Мах. шаг/об.
Ø40	1.4	8.0	328	52		0.8
					80	2.6
Ø42	1.4	8.0	328	56		0.9
					84	2.7
Ø50	1.3	8.0	353	72		1.3
					100	3.0
Ø52	1	8.0	459	76		1.1
					104	2.4
Ø63	1	8.0	459	98		1.6
					126	2.9
Ø66	1	8.0	459	104		1.8
					132	3.1
Ø80	1	8.0	459	132		2.4
					160	3.7
Ø100	0.9	8.0	510	172		3.0
					200	4.2
Ø125	0.9	8.0	510	222		4.1
					250	5.2

Врезание под углом

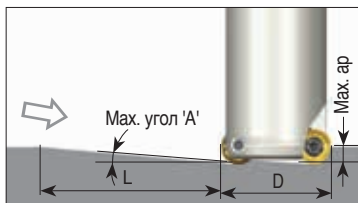

Спиральное врезание

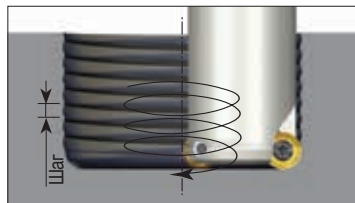

RDMX-05

(Ед. изм.: мм)

Диаметр фрезы (D)	Врезание под углом			Спиральное врезание		
	Мак. угол (A°)	Мак. ap	Мин. длина (L)	Мин. диаметр	Мак. диаметр	Мак. шаг/об.
Ø8	7	2.5	20	8.5	16	0.2
						2.1
Ø10	14	2.5	10	12	20	1.3
						2.1
Ø12	9	2.5	16	16	24	1.7
						2.1

RDMX-07

(Ед. изм.: мм)

Диаметр фрезы (D)	Врезание под углом			Спиральное врезание		
	Мак. угол (A°)	Мак. ap	Мин. длина (L)	Мин. диаметр	Мак. диаметр	Мак. шаг/об.
Ø15	17	3.5	11	18	30	2.4
						3.0
Ø16	15	3.5	13	20	32	2.9
						3.0
Ø17	14.5	3.5	14	22	34	1.6
						3.4
Ø20	14	3.5	14	28	40	3.0
						3.0
Ø25	8	3.5	25	38	50	3.0
						3.0
Ø30	5	3.5	40	48	60	3.0
						3.0
Ø32	5	3.5	40	52	64	3.0
						3.0

RXM(H)X-10

(Ед. изм.: мм)

Диаметр фрезы (D)	Врезание под углом			Спиральное врезание		
	Мак. угол (A°)	Мак. ap	Мин. длина (L)	Мин. диаметр	Мак. диаметр	Мак. шаг/об.
Ø20	20	5.0	14	22	40	1.9
						4.3
Ø25	15	5.0	19	32	50	5.0
						4.3
Ø32	12	5.0	24	46	64	1.6
						4.3
Ø42	8	5.0	36	66	84	4.3
						4.3
Ø50	6.5	5.0	44	82	100	4.3
						4.3
Ø52	6	5.0	48	86	104	4.3
						4.3

RXM(H)X-12

(Ед. изм.: мм)

Диаметр фрезы (D)	Врезание под углом			Спиральное врезание		
	Мак. угол (A°)	Мак. ар	Мин. длина (L)	Мин. диаметр	Мак. диаметр	Мак. шаг/об.
Ø25	20	6.0	16	28	50	2.9
						5.1
Ø32	15	6.0	22	42	64	5.1
						5.1
Ø35	8	6.0	43	48	70	4.9
						5.1
Ø40	15	6.0	22	58	80	5.1
						5.1
Ø42	7.5	6.0	46	62	84	5.1
						5.1
Ø50	7.5	6.0	46	78	100	5.1
						5.1
Ø52	6	6.0	57	82	104	5.1
						5.1
Ø63	5	6.0	69	104	126	5.1
						5.1
Ø66	5	6.0	69	110	132	5.1
						5.1
Ø80	4	6.0	86	138	160	5.1
						5.1
Ø100	2	6.0	172	178	200	5.1
						5.1
Ø125	2	6.0	172	228	250	5.1
						5.1

RXMX-16

(Ед. изм.: мм)

Диаметр фрезы (D)	Врезание под углом			Спиральное врезание		
	Мак. угол (A°)	Мак. ар	Мин. длина (L)	Мин. диаметр	Мак. диаметр	Мак. шаг/об.
Ø32	20	8.0	22	34	64	1.9
						6.8
Ø40	15	8.0	30	50	80	7.1
						6.8
Ø42	14	8.0	32	54	84	8.0
						6.8
Ø50	13	8.0	35	70	100	6.8
						6.8
Ø52	10	8.0	45	74	104	6.8
						6.8
Ø80	6	8.0	76	130	160	6.8
						6.8
Ø100	4	8.0	114	170	200	6.8
						6.8
Ø125	3.5	8.0	131	220	250	6.8
						6.8

RXMX-20

(Ед. изм.: мм)

Диаметр фрезы (D)	Врезание под углом			Спиральное врезание		
	Мак. угол (A°)	Мак. ар	Мин. длина (L)	Мин. диаметр	Мак. диаметр	Мак. шаг/об.
Ø50	16	10.0	35	62	100	9.2
						8.5
Ø63	11.5	10.0	49	88	126	8.5
						8.5
Ø80	9	10.0	63	122	160	8.5
						8.5
Ø100	7.5	10.0	76	162	200	8.5
						8.5
Ø125	5.5	10.0	104	212	250	8.5
						8.5
Ø160	4	10.0	143	282	320	8.5
						8.5

Врезание под углом

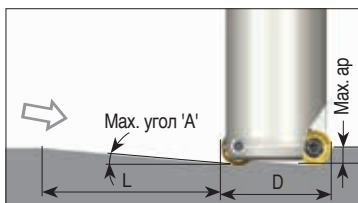

Спиральное врезание

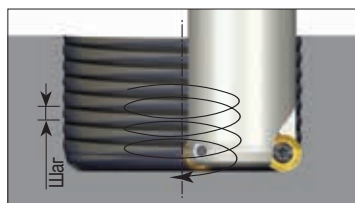

RYM(H)X-08

(Ед. изм.: мм)

Диаметр фрезы (D)	Врезание под углом			Спиральное врезание		
	Мак. угол (A°)	Мак. ап	Мин. длина (L)	Мин. диаметр	Мак. диаметр	Мак. шаг/об.
Ø16	2.5	4.0	92	18		0.2
					32	1.9
Ø17	2.5	4.0	92	20		0.3
					34	2.0
Ø18	2.5	4.0	92	22		0.5
					36	2.1
Ø20	4.0	4.0	57	26		1.1
					40	3.4
Ø21	4.0	4.0	57	28		1.3
					42	3.4
Ø25	4.0	4.0	57	36		2.1
					50	3.4
Ø26	4.0	4.0	57	38		2.2
					52	3.4
Ø32	4.0	4.0	57	50		3.4
					64	3.4
Ø40	7.0	4.0	33	66		3.4
					80	3.4

RYMX-10

(Ед. изм.: мм)

Диаметр фрезы (D)	Врезание под углом			Спиральное врезание		
	Мак. угол (A°)	Мак. ап	Мин. длина (L)	Мин. диаметр	Мак. диаметр	Мак. шаг/об.
Ø20	4.5	5.0	64	22		0.4
					40	4.2
Ø21	4.5	5.0	64	24		0.6
					42	4.4
Ø25	5.0	5.0	57	32		1.6
					50	4.3
Ø26	5.0	5.0	57	34		1.9
					52	4.3
Ø32	5.0	5.0	57	46		3.3
					64	4.3
Ø35	5.0	5.0	57	52		4.0
					70	4.3
Ø40	5.0	5.0	57	62		4.3
					80	4.3
Ø42	5.0	5.0	57	66		4.3
					84	4.3
Ø50	6.5	5.0	44	82		4.3
					100	4.3
Ø52	6.0	5.0	48	86		4.3
					104	4.3
Ø66	4.5	5.0	64	114		4.3
					132	4.3

RYMX-12

(Ед. изм.: мм)

Диаметр фрезы (D)	Врезание под углом			Спиральное врезание		
	Мак. угол (A°)	Мак. ар	Мин. длина (L)	Мин. диам.	Мак. диам.	Мак. шаг/об.
Ø25	6.0	6.0	57	28	50	0.8
						5.1
Ø26	6.0	6.0	57	30	52	1.1
						5.1
Ø32	12.0	6.0	28	42	64	5.1
						5.1
Ø33	12.0	6.0	28	44	66	5.1
						5.1
Ø35	12.0	6.0	28	48	70	5.1
						5.1
Ø40	10.0	6.0	34	58	80	5.1
						5.1
Ø42	12.0	6.0	28	62	84	5.1
						5.1
Ø50	9.0	6.0	38	78	100	5.1
						5.1
Ø52	8.0	6.0	43	82	104	5.1
						5.1
Ø55	8.0	6.0	43	88	110	5.1
						5.1
Ø63	7.0	6.0	49	104	126	5.1
						5.1
Ø66	6.5	6.0	53	110	132	5.1
						5.1
Ø80	4.5	6.0	76	138	160	5.1
						5.1
Ø100	3.5	6.0	98	178	200	5.1
						5.1
Ø125	2.5	6.0	137	228	250	5.1
						5.1

RYMX-16

(Ед. изм.: мм)

Диаметр фрезы (D)	Врезание под углом			Спиральное врезание		
	Мак. угол (A°)	Мак. ар	Мин. длина (L)	Мин. диам.	Мак. диам.	Мак. шаг/об.
Ø32	8.0	8.0	57	34	64	0.7
						6.8
Ø40	9.5	8.0	48	50	80	4.5
						6.8
Ø42	9.0	8.0	51	54	84	5.1
						6.8
Ø50	9.0	8.0	51	70	100	6.8
						6.8
Ø52	9.0	8.0	51	74	104	6.8
						6.8
Ø63	8.5	8.0	54	96	126	6.8
						6.8
Ø66	8.5	8.0	54	102	132	6.8
						6.8
Ø80	6.0	8.0	76	130	160	6.8
						6.8
Ø100	5.0	8.0	91	170	200	6.8
						6.8
Ø125	3.5	8.0	131	220	250	6.8
						6.8
Ø160	3.5	8.0	131	290	320	6.8
						6.8

RYMX-20

(Ед. изм.: мм)

Диаметр фрезы (D)	Врезание под углом			Спиральное врезание		
	Мак. угол (A°)	Мак. ар	Мин. длина (L)	Мин. диам.	Мак. диам.	Мак. шаг/об.
Ø50	8.0	10.0	71	62	100	4.5
						8.5
Ø63	12.5	10.0	45	88	126	8.5
						8.5
Ø80	8.5	10.0	67	122	160	8.5
						8.5
Ø100	6.5	10.0	88	162	200	8.5
						8.5
Ø125	4.5	10.0	127	212	250	8.5
						8.5
Ø160	4.0	10.0	143	282	320	8.5
						8.5
Ø200	2.5	10.0	229	362	400	8.5
						8.5
Ø250	2.4	10.0	239	462	500	8.5
						8.5

